



OPERATION MANUAL

DIGIFORCE[®] Model 9311

© 2018 burster
praezisionsmesstechnik gmbh & co kg
All rights reserved

Valid from: 13.08.2018

Manufacturer:

burster
praezisionsmesstechnik gmbh & co kg
Talstr. 1 - 5 P.O. Box 1432
76593 Gernsbach 76587 Gernsbach
Germany Germany

Tel.: +49-7224-645-0
Fax: +49-7224-645-88
Email: info@burster.com
www.burster.com

2770-BA9311EN-5170-081526

Warranty disclaimer

All information in the present documentation was prepared and compiled with great care and reproduced in accordance with effective control measures. This documentation may contain errors, and the information it contains and the corresponding technical data are subject to change without notice. Reproduction of any part of this documentation or its processing or revision using electronic systems is prohibited without the manufacturer's prior written approval.

Components, devices and measurement sensors made by burster praezisionsmesstechnik (hereinafter referred to as the "product") are the result of targeted development and meticulous research. From the date of delivery, burster provides a warranty for the proper condition and functioning of these products covering material and production defects for the period specified in the warranty document accompanying the product. However, burster waives any guarantee or warranty obligations or any additional liability for consequential damages caused by improper use of the product, in particular the implied guarantee of success in the market as well as the suitability of the product for a particular purpose. Furthermore, burster assumes no liability for direct, indirect or incidental damages or for consequential or other damages arising from the provision and use of the present documentation.

Trademark information

1-Wire[®] is a registered trade mark of Maxim Integrated. All brand names or trademarks mentioned in this document refer solely to the products concerned and are the property of their respective owners. By mentioning these trademarks, burster praezisionsmesstechnik gmbh & co kg is not laying claim to trademarks other than its own.

The measurement solution.



EU-Konformitätserklärung (nach EN ISO/IEC 17050-1:2010)

EU-Declaration of conformity (in accordance with EN ISO/IEC 17050-1:2010)

Name des Ausstellers: burster präzisionsmesstechnik gmbh & co kg
Issuer's name:

Anschrift des Ausstellers: Talstr. 1-5
Issuer's address: 76593 Gernsbach, Germany

Gegenstand der Erklärung: DIGIFORGE® X/Y-Monitoring, Einpress-, Füge-, Niet- und Verstemmüberwachung
Object of the declaration: DIGIFORGE® X/Y-Monitoring, press-fit, joining, rivet and caulking monitoring

Modellnummer(n) (Typ): DIGIFORGE® 9311
Model number / type:

Diese Erklärung beinhaltet obengenannte Produkte mit allen Optionen
This declaration covers all options of the above product(s)

Das oben beschriebene Produkt ist konform mit den Anforderungen der folgenden Dokumente:

The object of the declaration described above is in conformity with the requirements of the following documents:

Dokument-Nr. <i>Documents No.</i>	Titel <i>Title</i>	Ausgabe <i>Edition</i>
2011/65/EU	Richtlinie zur Beschränkung der Verwendung bestimmter gefährlicher Stoffe in Elektro- und Elektronikgeräten <i>Directive on the restriction of the use of certain hazardous substances in electrical and electronic equipment</i>	2011
2014/35/EU	Richtlinie zur Harmonisierung der Rechtsvorschriften der Mitgliedsstaaten über die Bereitstellung elektrischer Betriebsmittel zur Verwendung innerhalb bestimmter Spannungsgrenzen auf dem Markt <i>Directive on the harmonization of the laws of the Member States relating to the making available on the market of electrical equipment designed for use within certain voltage limits</i>	2014
2014/30/EU	Richtlinie zur Harmonisierung der Rechtsvorschriften der Mitgliedsstaaten über die Elektromagnetische Verträglichkeit <i>Directive on the harmonization of the laws of the Member States relating to electromagnetic compatibility</i>	2014
EN 61010-1	Sicherheitsbestimmungen für elektrische Mess-, Steuer-, Regel- und Laborgeräte – Teil 1: Allgemeine Anforderungen <i>Safety requirements for electrical equipment for measurement, control and laboratory use – Part 1: General requirements</i>	2010 + Cor.:2011
EN 61326-1	Elektrische Mess-, Steuer-, Regel- und Laborgeräte – EMV-Anforderungen – Teil 1: Allgemeine Anforderungen <i>Electrical equipment for measurement, control and laboratory use – EMC requirements – Part 1: General requirements</i>	2013
EN 55011	Industrielle, wissenschaftliche und medizinische Geräte – Funkstörungen – Grenzwerte und Messverfahren, Gruppe 1, Grenzwertklasse A <i>Industrial, scientific and medical equipment – Radio-frequency disturbance characteristics – Limits and methods of measurement, group 1, class A</i>	2009 + A1: 2010

Gernsbach 01.04.2016 i.V. Christian Karius
Ort / place Datum / date Quality Manager

Dieses Dokument ist entsprechend EN ISO/IEC 17050-1:2010 Abs. 6.1g ohne Unterschrift gültig /
According EN ISO/IEC 17050 this document is valid without a signature.

WARNHINWEIS: Dies ist ein Klasse A-Erzeugnis, vorgesehen für den Betrieb in einer industriellen Umgebung.
WARNING: This is a Class A-product, designed to operate in an industrial setting.

burster präzisionsmesstechnik gmbh & co kg · Talstr. 1-5 DE-76593 Gernsbach (P.O.Box 1432 DE-76587 Gernsbach) · Tel. +49-7224-6450 · Fax 645-88
www.burster.com · info@burster.com · burster is ISO 9001:2008 certified

Geschäftsführer/Managing Director: Matthias Burster · Handelsregister/Trade Register: Gernsbach · Registergericht/Register Court: Mannheim HRA 530170
Kompl./Gen. Partn.: burster präzisionsmesstechnik Verwaltungs-GmbH · Handelsregister/Trade Register: Gernsbach · Registergericht/Register Court: Mannheim HRB 530130
UST-Identnr./VAT No. DE 144 005 098 · Steuernr./Tax Ident No. 39454/10503
Commerzbank AG Rastatt Kto./Acc. 06 307 073 00 BLZ/Bank code 662 800 53 · Volksbank Baden-Baden* Rastatt eG Kto./Acc. 302 082 00 BLZ/Bank code 662 900 00

Contents

1	For your safety	9
1.1	Symbols used in the instruction manual	9
1.1.1	Signal words	9
1.1.2	Pictograms	10
1.2	Symbols and precautionary statements on the instrument	10
1.2.1	Conventions used in the instruction manual	10
2	Introduction	11
2.1	Intended use	11
2.2	Customer Service	11
2.2.1	Customer service department	11
2.2.2	Contact person	11
2.3	Download the test certificate	11
2.4	Ambient conditions	12
2.4.1	Storage conditions	12
2.4.2	Operating conditions	12
2.4.3	Restrictions on use	12
2.4.4	Cleaning	13
2.5	Personnel	13
2.6	Contents of pack	13
2.7	Unpacking	14
2.8	Warranty	14
2.9	Conversions and modifications	14
2.10	Error messages when the unit is powered up	15
3	Principles of design and operation	16
3.1	Range of functions	16
3.2	Versions	16
3.3	Power supply	17
3.4	Sensors suitable for use with the instrument	17
3.4.1	Automatic sensor identification (burster TEDS)	18
3.5	Recording measurement curves	18
3.5.1	Starting / stopping a measurement	18
3.5.2	Sampling the measurement signals	19
3.5.3	Defining an X-axis reference	19
3.6	Evaluation methods	20
3.7	Tare function	20
3.8	Sensor test	21
3.9	Online switching points	21
3.10	Visualizing, signalling and transferring results	21
3.11	Configuration tools	22
4	Controls and connections	23
4.1	Front panel	23

4.2	Rear of instrument	24
4.3	Touch control	25
4.4	Controls and symbols	26
4.5	Earthing and shielding	27
4.6	Connections	28
4.6.1	PLC I/O signals	28
4.6.2	Connector A – Potentiometer, Standard signal	30
4.6.2.1	Connector A: connecting potentiometric sensors.....	31
4.6.2.2	Connector A: connecting potentiometric sensors fitted with burster TEDS	31
4.6.2.3	Connector A: connecting standard-signal sensors	31
4.6.2.4	Connector A: connecting standard-signal sensors fitted with burster TEDS	32
4.6.3	Connector B – strain gage sensors, standard-signal sensors.....	33
4.6.3.1	Connector B: connecting strain gage sensors without sense leads	34
4.6.3.2	Connector B: connecting strain gage sensors without sense leads, fitted with burster TEDS.....	34
4.6.3.3	Connector B: connecting strain gage sensors with sense leads.....	34
4.6.3.4	Connector B: connecting strain gage sensors with sense leads, fitted with burster TEDS.....	35
4.6.3.5	Connector B: connecting standard-signal sensors	35
4.6.3.6	Connector B: connecting standard-signal sensors fitted with burster TEDS	35
4.6.3.7	Connector B: connecting a piezoelectric sensor (option).....	36
4.6.4	USB service port.....	37
4.6.5	Ethernet port	37
4.6.6	USB host port (memory-stick data logging).....	37
4.6.7	PROFIBUS interface.....	38
4.6.8	Ethernet-based Fieldbus interface (dual RJ45)	38
4.6.9	Instrument power plug	38
5	Using the instrument for the first time	39
5.1	Panel-mounting.....	39
5.1.1	Panel-mounting.....	39
5.1.2	Panel cutout	40
5.2	User language and diagnostics	41
6	Configuring the instrument - "Configuration Main Menu"	42
6.1	Basic setup	43
6.1.1	Function key definition	44
6.1.2	PLC outputs	46
6.1.3	PLC inputs	48
6.1.4	Access permissions	49
6.1.5	Measurement menus	51
6.1.6	Instrument information	52
6.1.7	LCD setting	52
6.1.8	Date and time.....	53
6.1.9	Language	53

6.1.10	Interfaces	54
6.1.10.1	USB interface parameters	54
6.1.10.2	Ethernet interface parameters	55
6.1.11	Acknowledgement function	56
6.1.12	Order sheet	57
6.1.13	USB flash	57
6.1.14	Channel settings	62
6.1.15	Diagnostics.....	63
6.1.16	PROFIBUS settings (option).....	64
6.1.17	PROFINET settings (option).....	65
6.1.18	EtherNet/IP settings (option).....	67
6.2	Program selection.....	69
6.3	Program Setup Menu.....	70
6.3.1	Channel settings	71
6.3.1.1	Scaling analog sensors (strain gage, potentiometer, standard signal sensors).....	72
6.3.1.2	Inverting measurement signals	73
6.3.1.3	Configuring sensors fitted with burster TEDS	73
6.3.1.4	Potentiometric sensors	74
6.3.1.5	Sensors that output a standard signal.....	83
6.3.1.6	Strain gage sensors.....	92
6.3.1.7	Piezoelectric sensors (option)	101
6.3.2	Measurement mode	106
6.3.2.1	Sampling the measurement channels	107
6.3.2.2	Measurement curve reference.....	107
6.3.2.3	Curve recording, return point.....	112
6.3.2.4	Start/Stop mode.....	113
6.3.3	Configuring the evaluation	115
6.3.3.1	Window	115
6.3.3.2	Trapezoid.....	120
6.3.3.3	Threshold.....	124
6.3.3.4	Envelopes	128
6.3.3.5	Tolerance band for evaluation elements	130
6.3.4	Online switching points	132
6.3.5	Graphical test operation.....	134
6.3.5.1	Graphical Test Operation - Zoom (adjust zoom for X/Y graphs).....	136
6.3.5.2	Graphical test operation – AutoSet	138
6.3.5.3	Graphical Test Operation – Configuring a window.....	140
6.3.5.4	Graphical Test Operation – Configuring a trapezoid	145
6.3.5.5	Graphical Test Operation – Configuring a threshold.....	150
6.3.5.6	Graphical Test Operation – Generating an envelope.....	155
6.3.5.7	Graphical test operation – Cursor	159
6.3.5.8	Graphical test operation – Reference curve.....	161
6.3.5.9	Graphical Test Operation – Displaying a curve array	163

6.3.6	Numerical test operation.....	165
6.3.6.1	Numerical Test Operation - Live sensor values	166
6.3.6.2	Numerical Test Operation – Tare.....	168
6.3.6.3	Numerical Test Operation - PLC signals.....	169
6.3.7	Sensor test.....	171
6.3.8	User-defined values.....	173
6.3.9	USB flash.....	176
6.4	Copy programs.....	177
6.4.1	Copying a measurement program or sensor settings.....	177
6.4.2	Deleting a measurement program.....	179
6.5	Curve analysis (Viewer).....	180
6.5.1	Curve analysis - Selection	182
6.5.2	Curve analysis - Zoom.....	183
6.5.3	Curve analysis - Numerical.....	184
7	Measurement results display - Measurement mode.....	186
7.1	Top-level view of measurement results.....	186
7.1.1	Global header	187
7.1.2	Status/error indicator in measurement mode	187
7.1.3	Overall result of last measurement.....	188
7.1.4	Individual evaluation status in measurement mode.....	188
7.2	M1 Graphical measurement curve	189
7.3	M2 General curve data	190
7.4	M3 Total result.....	191
7.5	M4 Entry/Exit	192
7.6	M5 User defined values.....	192
7.7	M6 Statistics	193
7.8	M7 Order sheet.....	194
8	Signal timing diagrams.....	195
8.1	Selecting a measurement program	195
8.1.1	Changing the measurement program without program acknowledgement.....	195
8.1.2	Changing the measurement program with program acknowledgement.....	196
8.2	Starting a measurement	197
8.2.1	Measurement without measurement-data logging	197
8.2.2	Measurement with measurement-data logging	198
8.2.3	Measurement using data logging on USB stick (READY control enabled).....	199
8.3	External tare	200
8.3.1	Without tare warning.....	200
8.3.2	With tare warning.....	201
8.4	Online signals.....	202
8.4.1	Window evaluation with online signal.....	202
8.4.2	Online switching signals S1 to S6.....	203
8.4.2.1	Switching signals for X-channel with "Absolute" reference.....	203
8.4.2.2	Switching signals for X-channel with "Trigger" reference	204

8.4.2.3	Switching signals for Y-channel	205
8.5	Acknowledgement function.....	206
8.5.1	Example of an NOK evaluation for the following configuration.....	206
8.5.2	Example of an NOK evaluation (without acknowledgement).....	207
8.5.3	Example of an OK evaluation (without acknowledgement)	208
8.6	External actuation of a statistics reset	209
8.7	External actuation of a sensor test	210
9	Customer Services for your DIGIFORCE[®] 9311	211
10	Technical data.....	212
10.1	Electromagnetic compatibility	212
10.1.1	Interference immunity	212
10.1.2	Interference emission.....	212
11	Accessories available	213
11.1	Software.....	213
12	Disposal.....	214
13	Index	215



1 For your safety

The following symbols on the DIGIFORCE® 9311 and in this operation manual warn of hazards.

1.1 Symbols used in the instruction manual

1.1.1 Signal words



The following signal words are used in the operation manual according to the specified hazard classification.

	<h2>DANGER</h2>
<p>High degree of risk: indicates a hazardous situation which, if not avoided, will result in death or serious injury.</p>	
	<h2>WARNING</h2>
<p>Moderate degree of risk: indicates a hazardous situation which, if not avoided, may result in death or serious injury.</p>	
	<h2>CAUTION</h2>
<p>Low degree of risk: indicates a hazardous situation which, if not avoided, could result in minor or moderate injury.</p>	
<h2>NOTICE</h2>	
<p>Property damage to the equipment or the surroundings will result if the hazard is not avoided.</p>	

Note: It is important to heed these safety notices in order to ensure you handle the DIGIFORCE® 9311 correctly.

IMPORTANT: Follow the information given in the operation manual.

1.1.2 Pictograms

Symbol	Description
	Electric shock hazard
	Electrostatic discharge. Do not touch! Take precautionary measures against static discharge.
	Observe the advice for protecting the instrument.

1.2 Symbols and precautionary statements on the instrument

Symbol	Description
	Hazard warning Disconnect the power plug before opening – Follow safety instructions – Professional servicing only
Warning ! To prevent electrical shock do not open device.	Warning of electrical shock hazard Do not open the unit.
To prevent fire replace only with same type and rating of fuse !	Warning of fire hazard Always replace the fuse with a fuse of the same type and rating.

1.2.1 Conventions used in the instruction manual

Designation	Description
[Fx]	Function keys F1 to F3 on the touchscreen display
[Text]	Buttons on the touchscreen display
"Term"	Terms used in the instrument menus

2 Introduction

IMPORTANT: Read the operation manual carefully before using the equipment, and keep for future reference.

2.1 Intended use

The DIGIFORCE[®] 9311 is an instrument that is designed to monitor repetitive production processes. Its core function is to record and analyse process signals representing physical variables between which there is a defined relationship, for instance recording a curve of force, pressure or torque plotted against displacement, angle or time. Graphical evaluation elements such as windows, trapezoids, thresholds or envelopes are used to analyse the resultant curve. The analysis result is classified as "OK" or "NOK" (Not OK) and output at various interfaces.

The instrument is NOT intended as a safety device. For instance it is not suitable as an emergency device for shutting down a press if the pressing force exceeds a threshold value.

2.2 Customer Service

2.2.1 Customer service department

For repair inquiries, please telephone our Service department on +49 7224 645-53, or email: service@burster.com (Germany only). If you are outside Germany, you should contact your burster agent (see also www.burster.com).

Please have the serial number to hand. The serial number is essential to establishing the definite technical status of the instrument and providing help quickly. You will find the serial number on the type plate of the DIGIFORCE[®] 9311.

2.2.2 Contact person

If you have any questions relating to the DIGIFORCE[®] 9311, please go directly to burster praezisionsmesstechnik gmbh & co. kg, or if outside Germany, please contact your burster agent (see also www.burster.com).

Head office

burster praezisionsmesstechnik gmbh & co kg
Talstraße 1 - 5
D-76593 Gernsbach
GERMANY

Telephone: (+49) 07224 645-0

Fax: (+49) 07224 645-88

Email: info@burster.de

2.3 Download the test certificate

You have the option to download the test certificate for your DIGIFORCE[®] 9311 online. To do this, you need to register at <http://www.burster.com/en/registration/>. You can then download the test certificate directly by entering the serial number.

2.4 Ambient conditions

2.4.1 Storage conditions

The following requirements must be met when storing the DIGIFORCE[®] 9311:

- Store at temperatures between 0 °C and +60 °C
- The unit must be packed in clean packaging
- Store in a dry environment
- No condensation

2.4.2 Operating conditions

The following requirements must be met when operating the DIGIFORCE[®] 9311:

- Always operate indoors
- Maximum height above sea level 2000 m
- Operate at temperatures between +5 °C and +40 °C, ideally +23 °C
- Humidity: 80% up to +31 °C, decreasing linearly above that temperature to 50% at T_{\max} , no condensation
- Class of protection: 1
- Transient overvoltage category: CAT II
- Potential with respect to ground: ≤ 12 VDC between analog ground and ground
- Supply voltage: 100 to 240 VAC_{eff} (± 10 %), 50 to 60 Hz (± 10 %)

Note: Avoid condensation after transportation or storage of the DIGIFORCE[®] 9311.

2.4.3 Restrictions on use

The DIGIFORCE[®] 9311 does not pose a hazard if used within its specification and in accordance with the safety regulations.

The manufacturer does not accept liability for any personal injury or property damage arising from misinterpretation of measurement results.

Note: The DIGIFORCE[®] 9311 is not intended as a substitute for safety devices and protective equipment. Use safety devices and protective equipment.

2.4.4 Cleaning

	 DANGER
<p>Electrical shock hazard Disconnect the DIGIFORCE® 9311 from the power plug before cleaning.</p>	

Disconnect the DIGIFORCE® 9311 from the power plug and use a slightly damp cloth for cleaning the unit.

	NOTICE
<p>Do not immerse the DIGIFORCE® 9311 in water or hold it under running water. Do not use strong cleaning agents as these may damage the instrument. Use a slightly damp cloth to clean the instrument.</p>	

2.5 Personnel

Personnel must be familiar with the relevant regulations. They must follow these regulations. Only trained personnel who are familiar with the applicable safety regulations are permitted to operate the DIGIFORCE® 9311.

burster is happy to provide your operating personnel with training on the DIGIFORCE® 9311. To find out more, please look at our range of services at www.burster.com.

2.6 Contents of pack

The following components are supplied:

- DIGIFORCE® 9311
- Operation manual including burster software DVD
- 1 x power lead
- Warranty document
- Test certificate

2.7 Unpacking

	 DANGER
	<p>Electrical shock hazard</p> <p>Never switch on the instrument if it shows signs of damage incurred in transit. Only ever use the instrument under the conditions specified in this operation manual.</p>

Inspect the instrument for damage. If you suspect that the unit has been damaged during shipping, notify the delivery company within 72 hours.

The DIGIFORCE® 9311 should be shipped only in its original packaging or in packaging capable of providing an equivalent degree of protection.

2.8 Warranty

burster praezisionsmesstechnik gmbh & co kg provides a manufacturer's warranty for a period of 24 months after delivery.

Any repairs required during this time will be made without charge. This does not include damage arising from improper use.

Please note the following when sending the instrument in for repair:

- If there is a problem with the device, please attach a note to the instrument case summarizing the fault.
- Technical specifications subject to change at any time without notice.
We also state explicitly that we do not accept liability for consequential damage.
- The instrument must always be dispatched in suitable packaging.

2.9 Conversions and modifications

Note: The warranty shall be deemed void **immediately** if you open or dismantle the DIGIFORCE® 9311 during the warranty period.

The DIGIFORCE® 9311 does not contain any parts that are intended to be serviced by the user. Only the manufacturer's own qualified personnel are permitted to open the DIGIFORCE® 9311.

It is not permitted to make any changes to the DIGIFORCE® 9311 without the written agreement of burster praezisionsmesstechnik gmbh & co kg. burster praezisionsmesstechnik gmbh & co kg does not accept liability for damages or injury if this condition is disregarded.

2.10 Error messages when the unit is powered up

During boot-up, the DIGIFORCE® 9311 may display certain error messages.

The following errors mean that the DIGIFORCE® 9311 must be sent in for checking and possibly repair:

German error message	English error message
"Nichtflüchtige Daten korrupt"	"Non-volatile data error"
"Abgleich Fehler"	"Calibration error"
"EEPROM von Analogplatine ist leer"	"EEPROM of analog board is empty"
"Fehler beim Lesen der MAC Adresse"	"MAC Address Reading Error"

In any of these cases, please call our Service department on (+49) 07224 645-53 or email: service@burster.com (Germany only). If you are outside Germany, you should contact your burster agent (see also www.burster.com).

Please refer to the additional guidance on packaging in section 2.7 "Unpacking" on page 14.

If any of the following error messages arise, you must contact our Service department (Germany only). If you are outside Germany, you should contact your burster agent (see also www.burster.com).

German error message	English error message
"Analogplatine wurde getauscht"	"Analog board has been exchanged"
"Fehler beim Lesen der Seriennummer"	"Serial Number Reading Error"

For further information, please refer to section 2.2 "Customer Service" on page 11.

3 Principles of design and operation

Please refer to the DIGIFORCE® 9311 data sheet for full details of dimensions, weight, degree of protection etc.

3.1 Range of functions

The DIGIFORCE® 9311 monitors processes in which precisely defined functional relationships need to be demonstrated between two measured quantities. These measured quantities are recorded synchronously during the manufacturing process or subsequent functional testing to produce a measurement curve, which is then assessed using graphical evaluation elements. After evaluating the measurements, the instrument displays the measurement curve and computed evaluation results on the colour display and outputs this data at the external control interfaces. A powerful real-time operating system optimizes processes in the DIGIFORCE® 9311 to achieve an extremely fast evaluation cycle. It typically takes just 25 ms to deliver the global OK or NOK evaluation result, which can then be analysed by a higher-level controller.

In addition to the traditional evaluation windows with defined entry and exit sides, with the DIGIFORCE® 9311 you can also use thresholds, trapezoids of type X or Y and envelopes as graphical evaluation elements.

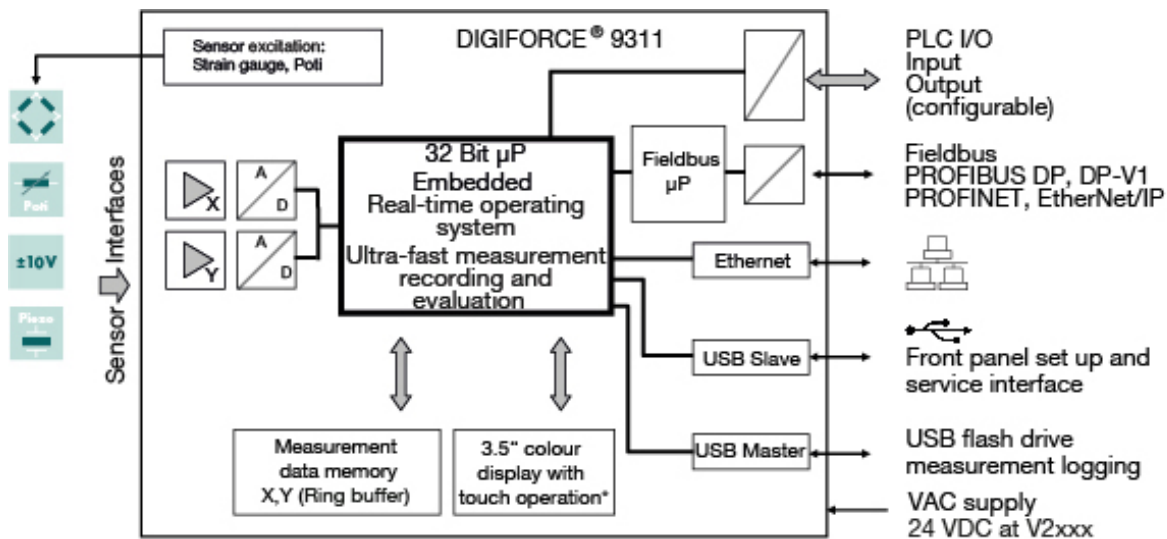

Diagram 1: Block diagram of the DIGIFORCE® 9311

3.2 Versions

Please refer to the data sheet for details of the different versions. You can obtain the latest data sheet and additional information on the DIGIFORCE® 9311 from <http://goo.gl/muUe7D> or simply use the QR code below:



DIGIFORCE[®] model 9311

3.3 Power supply

The instrument can be operated with a voltage of 100 to 240 VAC ($\pm 10\%$) / 50 to 60 Hz ($\pm 10\%$) / typical 15 VA.

	DANGER
	<p>Electrical shock hazard</p> <p>Inspect the power lead for damage before use. Do not connect the power lead if there are signs of damage.</p> <p>To help identify damage to the power lead in good time, test it regularly in accordance with national accident prevention regulations.</p>

3.4 Sensors suitable for use with the instrument

The DIGIFORCE[®] 9311 can process signals from a huge range of sensor technologies.

Note: The "Channel settings" menu (M21) is where the physical connectors, and hence the particular sensors, are assigned to the measured curve (X/Y curve); see section 6.3.1 "Channel settings" on page 71.

The DIGIFORCE[®] 9311 works with these sensor technologies:

Symbol	Type	Connector
	Strain gage sensors	B
	Potentiometers	A
	Sensors with standard signal (process signal)	A, B
	Piezoelectric (option)	B*

*Connector B (Piezoelectric) is available as an option.

Note: There is no strain-gage connection when the optional piezo connection is used.

Examples of connected sensors

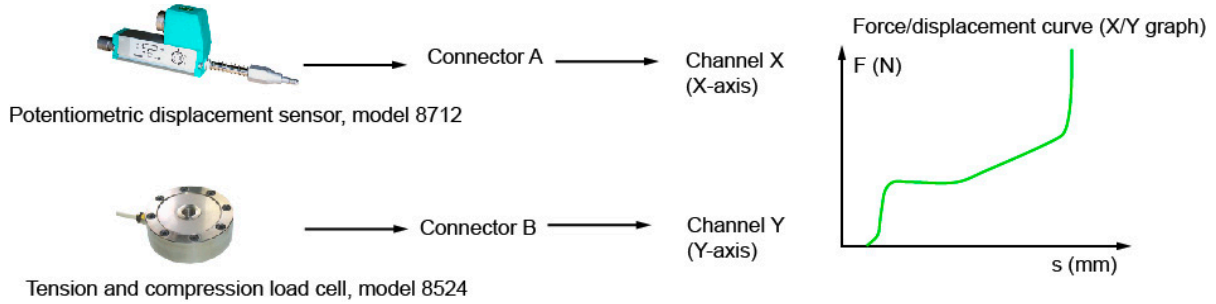

Diagram 2: Examples of connected sensors

3.4.1 Automatic sensor identification (burster TEDS)

DIGIFORCE[®] 9311 uses the burster TEDS (Transducer Electronic Data Sheet) to provide automatic sensor recognition, i.e. the instrument reads the relevant sensor specification from an EEPROM, fitted in the sensor plug, and can then use this data to perform the necessary channel configuration automatically. The memory chip in the sensor plug is programmed when the sensor is first ordered or subsequently calibrated. The burster TEDS feature is only available for sensors with a permanently fitted connecting lead.

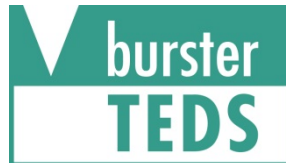

Diagram 3: burster TEDS label

3.5 Recording measurement curves

An external control signal or an internal condition triggers the measurement. On receiving this active start condition, the DIGIFORCE[®] 9311 immediately starts writing the values measured by the sensors as X/Y value pairs to the measured-value memory. The DIGIFORCE[®] 9311 stops the measurement again when a stop condition is met.

Then the DIGIFORCE[®] 9311 immediately evaluates the recorded measurement curve. In this evaluation, the DIGIFORCE[®] 9311 checks whether the measurement curve satisfies all the defined graphical evaluation elements. If so, the measurement is assessed to be OK. If, however, there is at least one infringement, the DIGIFORCE[®] 9311 gives the measurement an NOK evaluation.

As soon as it has completed the evaluation, the DIGIFORCE[®] 9311 refreshes the measurement mode display and updates the control signals at the PLC interface.

3.5.1 Starting / stopping a measurement

You can use various events as the start signal and stop signal, which can be mutually independent.

Starting a measurement

- External control signal.
- Measured value goes above or below a defined X-value (e.g. a displacement value).
- Measured value goes above or below a defined Y-value (e.g. a force value) (not for piezoelectric sensors).

Stopping a measurement

- External control signal.
- Measured value goes above or below a defined X-value (e.g. a displacement value).
- Measured value goes above or below a defined Y-value (e.g. a force value).
- Time (timeout).
- Configurable number of recorded measured values reached.

3.5.2 Sampling the measurement signals

DIGIFORCE® 9311 supports three different sampling methods, which you can enable in combination. In addition to time-based sampling, you can record the pairs of measured values using a configurable Delta(Δ)X value or Delta(Δ)Y value. This allows the DIGIFORCE® 9311 to use only the optimum number of sample points to record a curve accurately and to reproduce it in full. For instance, it uses only a very few points to measure a force/displacement curve that has a low gradient over the initial travel region of the joining process followed by a steep section as it rises into an end-point force.

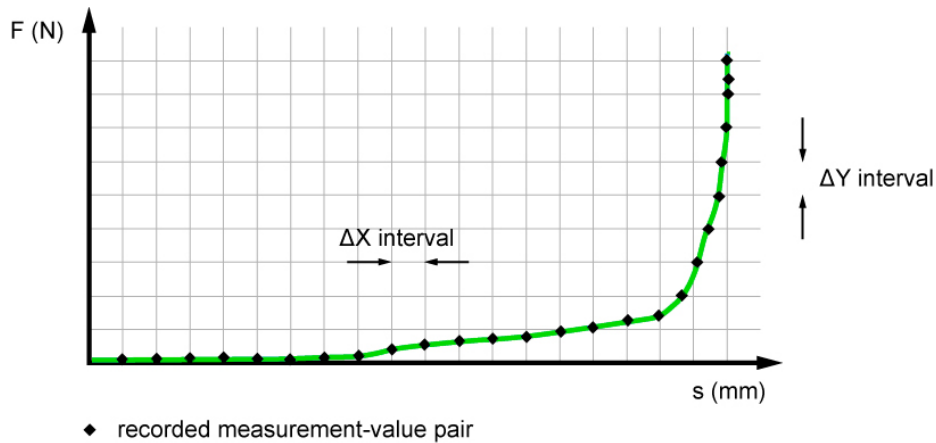

Diagram 4: Sampling the measurement signals

3.5.3 Defining an X-axis reference

A measurement curve recorded by the DIGIFORCE® 9311 can be based on a choice of references. For instance for a force/displacement curve, the reference can be a particular displacement value. In a conventional application using an "Absolute" reference, the reference point equals the zero point of the position measurement system. Component tolerances or tolerances in tool changeover systems, workpiece mounts etc. result in variation (spread) in the X-values of the measurement curves. This spread might mean that the result from an evaluation element falls in the NOK category. You can eliminate this spread, however, by using a different reference point.

The DIGIFORCE® 9311 provides the following reference options:

- Absolute
- Final force
- Crossing reference line
- Crossing trigger threshold.

3.6 Evaluation methods

As a universal evaluation tool, the DIGIFORCE® 9311 provides a wide selection of configurable graphical evaluation elements. These can be used for OK/NOK classification of a vast range of curve types.

In addition to traditional windows with defined entry and exit sides, the DIGIFORCE® 9311 also provides thresholds, trapezoids of type X or Y and envelopes as graphical evaluation elements. These give you the extra flexibility you need to evaluate practically any type of signal curve.

You can configure the graphical evaluation elements both by entering numerical values and graphically using one or more recorded measurement curves.

Summary of the evaluation elements

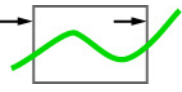
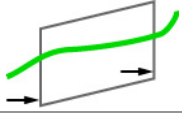
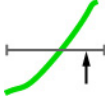
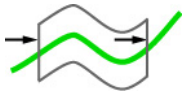
Symbol	Evaluation element	Max. number
	Window with configurable entry/exit sides, online signal, entry/exit, min/max value	3
	X or Y trapezoid, configurable entry/exit side	2
	X or Y threshold, configurable crossing	2
	Envelope, configurable entry/exit side	1

3.7 Tare function

The tare function can be used to correct for static offsets on the sensor channels. For instance you can correct for a varying background load caused by a tool changeover system by running the tare function before every measurement. You can also set a warning limit for sensors, which can be used to detect signs of wear in good time and hence avoid any associated measurement errors. If the current measured value exceeds the stored warning limit while the tare function is active, the DIGIFORCE® 9311 issues the "OUT_WARNING_TARE" warning signal.

Options for initiating the tare function

- Manually in the "Numerical test operation" menu (M58)
- Automated trigger via the control interface (PLC I/O or Fieldbus "IN_TARE_X", "IN_TARE_Y", "IN_TARE_X+Y")
- Automatically when a measurement starts

3.8 Sensor test

Regular checking of sensors plays a crucial role in the test reliability of a quality control system. In these checks, defined physical quantities are applied to the sensors. The DIGIFORCE[®] 9311 then evaluates the resultant electrical signals.

An example of how to calibrate these values is to use a feed unit to move into a reproducible position such as the top limit of travel for the press, or up to a master part. In this position, the DIGIFORCE[®] 9311 captures the channel measurements and applies tolerance limits to these measured values.

Then measurements are performed again precisely at these positions in the regular sensor test. The sensor test, initiated by a PLC signal ("IN_STEST"), checks the sensor values at these positions. If a sensor lies outside the tolerance range, DIGIFORCE[®] 9311 sends a warning signal to the PLC ("OUT_OK_STEST" = 0). This practically eliminates any erroneous measurements from faulty or drifting sensor systems.

3.9 Online switching points

The online switching points can be used to output in real time a signal at the control interface (PLC I/O or Fieldbus) if a set signal level is exceeded. Switching points S1 to S6 are provided for this function. You are free to choose their switching polarity and can assign them to the X and Y measurement channels as you wish.

When assigning a switching signal to the X-channel, you can choose to refer the set level (threshold value) to the absolute zero point ("Absolute" reference) or to a relative zero point ("Trigger" reference).

These switching points are updated in real time both during and outside an active measurement cycle.

3.10 Visualizing, signalling and transferring results

The DIGIFORCE[®] 9311 shifts immediately into the evaluation phase at the end of a measurement. In this phase, the unit checks whether the measurement curve meets the conditions of the graphical evaluation elements such as a window or envelopes. If the conditions are met, the DIGIFORCE[®] 9311 assesses the measurement as OK. If, however, it identifies an infringement of the graphical evaluation elements, it assesses the measurement as NOK.

In parallel with updating the global OK/NOK result at the end of the measurement, the DIGIFORCE[®] 9311 also refreshes the active measurement window in the display. In addition, it updates the relevant PLC I/O signals and also any status signals and result values at the Fieldbus interface. Once a measurement has finished, you can retrieve curve data and measurement results via the communications interfaces (Ethernet and USB). You can also use the DigiControl PC software to log this data automatically after every measurement. This process can also run synchronously on more than one DIGIFORCE[®] 9311 unit at once. In addition, you can log the data on a USB stick and display the most recent measurements in the "Graphical Curve analysis" menu (M70).

3.11 Configuration tools

The DIGIFORCE® 9311 provides a configuration mode, which is designed to help you set up the entire measurement chain ready for use. This configuration mode contains the "Numerical test operation" menu (M58) and the "Graphical test operation" menu (M59), which lets you set and edit evaluation elements graphically.

After connecting or configuring a new sensor, you can use the "Numerical test operation" menu (M58) to get a first impression, because it displays the live sensor values from all active measurement channels. You can also use this menu for calibrations based on static measured values. In addition, the menu displays the digital PLC I/O signals and lets you set or reset the individual signals.

In the "Graphical test operation" menu (M59), you can create and edit individual graphical evaluation elements such as windows. The DIGIFORCE® 9311 can display one or more measurement curves to help you. Using these curves as a reference, you can set the evaluation elements and adjust their position and size. The "Graphical test operation" menu (M58) includes the "Cursor" function as a tool for viewing curve details.

DIGIFORCE® model 9311

4 Controls and connections

4.1 Front panel

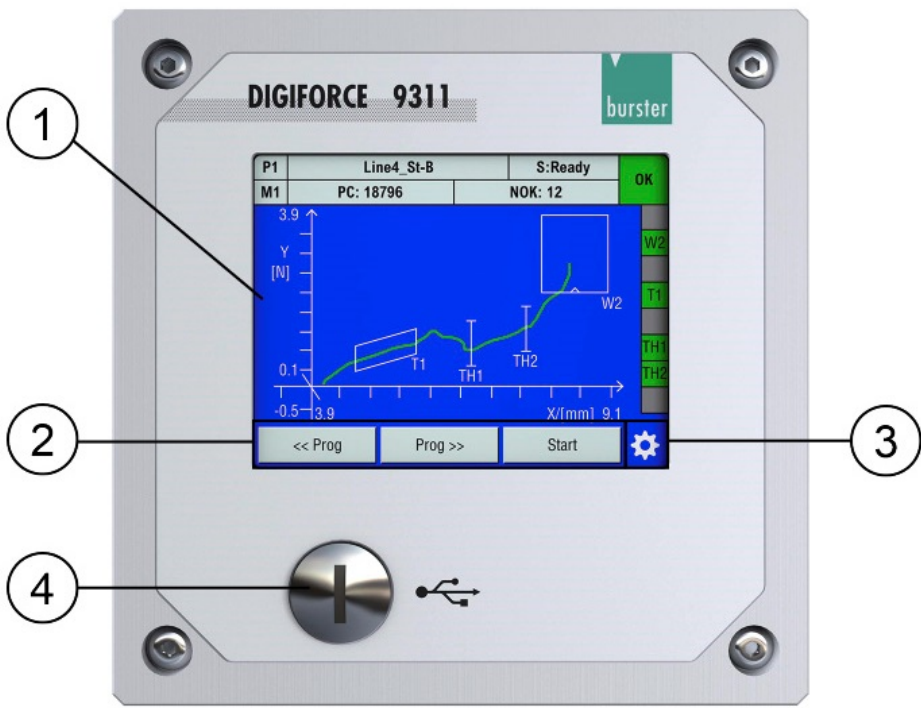



Diagram 5: Front view of the DIGIFORCE® 9311

Label	Description
1	Touchscreen display
2	User-definable function keys [F1] to [F3]
3	Settings ("Configuration Main Menu")
4	Front-panel USB service port

Note: You can choose to have the function keys and the  icon displayed permanently or temporarily in measurement mode. For further details, please see section 6.1.1 "Function key definition" on page 44.

4.2 Rear of instrument

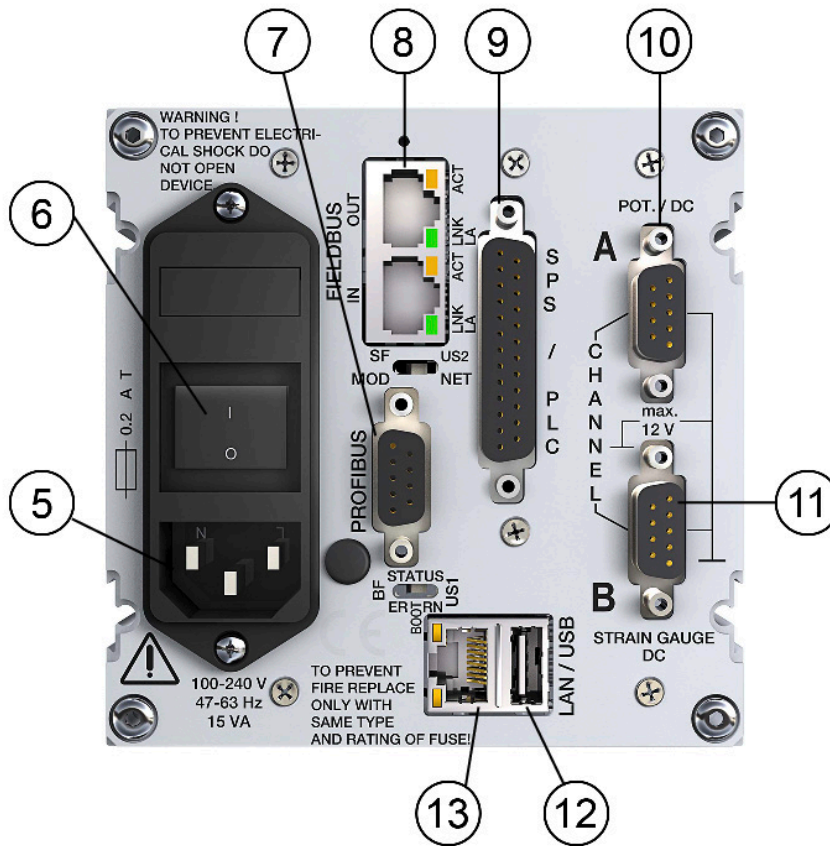

Diagram 6: Rear view of the DIGIFORCE® 9311

Label	Description
5	Mains power connection
6	Power switch
7	PROFIBUS DP-V0 / DP-V1 (optional)
8	Ethernet-based Fieldbus ports (optional)
9	PLC I/O signals
10	A, standard analog connection (potentiometer, standard signal)
11	B, standard analog connection (strain gage, standard signal or piezoelectric input (optional))
12	Rear USB port (USB host port)
13	Ethernet port





Note: The LEDs for the Fieldbus interfaces are described in the relevant supplementary documentation (e.g. the DIGIFORCE® 9311 PROFIBUS manual).

DIGIFORCE® model 9311

4.3 Touch control







The DIGIFORCE® 9311 has a touchscreen display. You can tap or swipe the touchscreen to perform control actions.

Touch control options

Action	Description	Symbol used in the operation manual
	Tap the relevant point on the touchscreen with your finger.	
	Swipe your finger downwards or upwards on the touchscreen.	
	Swipe your finger to left or right on the touchscreen.	

4.4 Controls and symbols

This is a list of the common control buttons and icons displayed on the DIGIFORCE[®] 9311:

Icon	Meaning
	This icon opens the "Configuration Main Menu".
	This icon always takes you back to the previous menu. Note: The settings you have made are normally adopted.
	You can choose to tap on the scroll bar or swipe  the scroll bar to reach other menu pages.
[ENTER]	Use this button to confirm your selection.
[ESC]	Use this button to close the selection menu.
[OK]	Use this button to enter the data you have entered via the keypad.
[+] / [-]	Use these buttons to increment / decrement any settings.
<input checked="" type="checkbox"/> / <input type="checkbox"/>	Checkbox enabled / disabled
<input checked="" type="radio"/> / <input type="radio"/>	Radio button enabled / disabled
	You can use this icon to zoom in on an area of the touchscreen by selecting the icon then touching the area you want to enlarge.
	You can use this icon to automatically adjust the scale of the measurement curve to fit the entire curve including the graphic evaluation elements in the display.
	Padlock = "IN_AUTO" control signal = 1 (active). The DIGIFORCE [®] 9311 is kept in measurement mode and access to the configuration level is locked.

4.5 Earthing and shielding

The DIGIFORCE[®] 9311 is earthed (grounded) via the PE conductor of the IEC cold connector (Class I appliance).

In compliance with EN 61010-1, exposed parts that become live in the event of a fault are earthed (grounded). This prevents such parts from carrying hazardous voltages.

Use a suitable connecting cable with a dual-shield construction (aluminium foil plus braided shield) for connecting sensors, communication interfaces and Fieldbus interfaces and for the PLC I/O signal control lines. Ideally you should connect sensors using burster connecting cables and with a minimum length of cable. When using mains leads from other manufacturers or an international mains connection, you must ensure that there is a proper connection to earth.

We strongly recommend the following:

- Use metallic or metal-plated connecting plugs. Connect the braided shield of shielded cables to the connector casing.
- As a general rule, keep sensor connecting leads as short as possible, and especially for piezoelectric sensors.
- It is best to use a suitable connecting cable from the sensor manufacturer for connector B (piezoelectric).
- When using control lines from remote PLC systems, make sure all the system components are suitably earthed.
- When using detachable extension leads, make sure the shielding is continuous.
- Position signal lines away from supply lines (in particular when laying cables near servomotors).

4.6 Connections

4.6.1 PLC I/O signals

	NOTICE
	<p>+24 VDC supply voltage Only connect devices that are designed for this supply voltage.</p>

The PLC control signals (inputs and outputs) are provided on the DIGIFORCE[®] 9311 at the 25 pin D-SUB port. The signals are isolated from the controller core and work with positive logic. An external 24 VDC supply is needed to operate the PLC outputs; the DIGIFORCE[®] 9311 does not provide an auxiliary voltage.

The PLC outputs of the DIGIFORCE[®] 9311 use sourcing logic (p-switching).

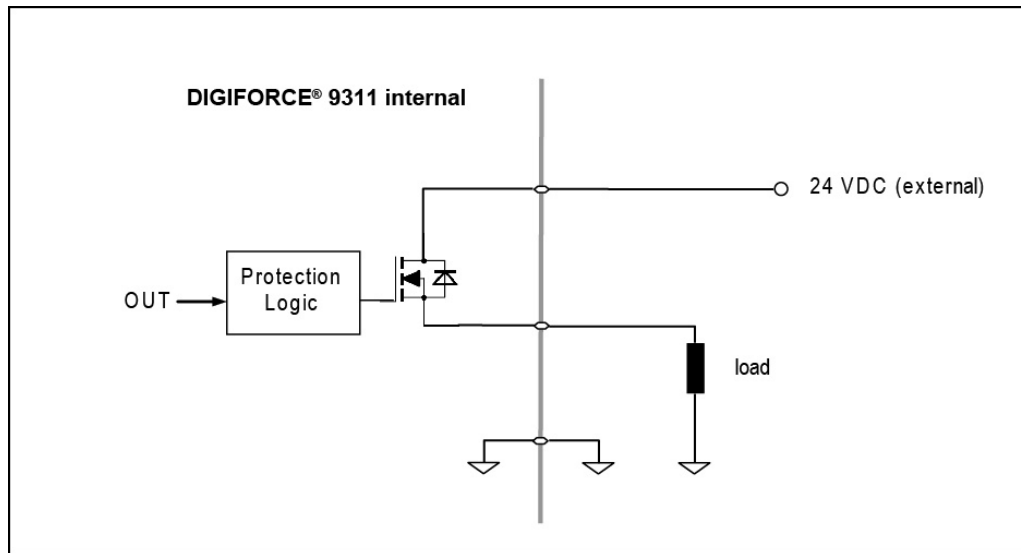

Diagram 7: PLC output

Pin assignment for the 25 pin D-SUB socket (female)

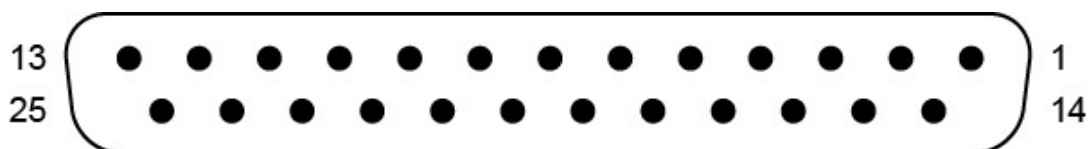

Diagram 8: 25 pin D-SUB socket (female)

DIGIFORCE® model 9311

Note: Note that some PLC inputs and some PLC outputs can be configured with a different signal assignment (for further details, please see section 6.1.2 "PLC outputs" on page 46 and section 6.1.3 "PLC inputs" on page 48). The following pin assignments show the factory settings.

PIN	Signal name	Configurable	Assignment
1	+24 VDC	-	24 VDC external voltage supply
2	GND_EXT	-	PLC-GND reference potential +24VDC_EXT
3	IN_START	No	External measurement start / stop
4	IN_TARE_X	Yes	Tare the X-channel
5	IN_RES_STAT	Yes	Reset the statistics
6	IN_STEST	Yes	Run the sensor test
7	IN_STROBE	No	Adopt the measurement program no. from IN_PROG[]
8	IN_PROG0	No	Bit 0 of measurement program no. (binary coded)
9	IN_PROG1	No	Bit 1 of measurement program no. (binary coded)
10	IN_PROG2	No	Bit 2 of measurement program no. (binary coded)
11	IN_AUTO	No	DIGIFORCE® 9311 is kept in measurement mode
12	IN_PROG3	No	Bit 3 of measurement program no. (binary coded)
13	OUT_BUZZER	No	PWM signal for external buzzer
14	OUT_READY	No	Ready signal for measurement
15	OUT_OK	No	Evaluation result OK
16	OUT_NOK	No	Evaluation result NOK
17	OUT_NOK_ONL	No	Online NOK, live signal from the "Window" evaluation element
18	OUT_S1	No	Online switching signal S1
19	OUT_S2	No	Online switching signal S2
20	OUT_OK_STEST	Yes	Result of sensor test
21	OUT_STROBE	Yes	Acknowledge signal for measurement program selection
22	OUT_PROG0	Yes	Bit 0 of echoed measurement program
23	OUT_PROG1	Yes	Bit 1 of echoed measurement program
24	OUT_PROG2	Yes	Bit 2 of echoed measurement program
25	OUT_MEAS_ACT	Yes	Measurement in progress

4.6.2 Connector A – Potentiometer, Standard signal

	<h3>NOTICE</h3>
	<p>+5 VDC sensor excitation voltage Only connect sensors that are designed for this excitation voltage.</p>

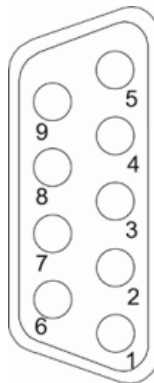

Diagram 9: Connector A

PIN	Assignment
1	+ excitation for potentiometer
2	+ sense
3	not used
4	- sense
5	- excitation for potentiometer
6	+ signal (input)
7	burster TEDS: 1-Wire [®] EEPROM
8	not used
9	- signal (input)
housing	shield (ground potential)

Note: The 1-Wire[®] interface uses the shield as the ground potential.

DIGIFORGE[®] model 9311

4.6.2.1 Connector A: connecting potentiometric sensors

You can connect potentiometric sensors to connector A.

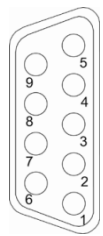

Connector A, looking towards instrument rear (socket)

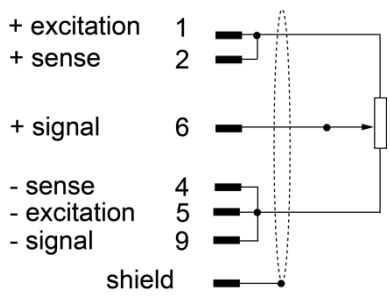
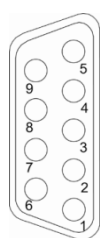

Diagram 10: Connector A: potentiometric sensors

4.6.2.2 Connector A: connecting potentiometric sensors fitted with burster TEDS

You can connect potentiometric sensors fitted with burster TEDS to connector A.



Connector A, looking towards instrument rear (socket)

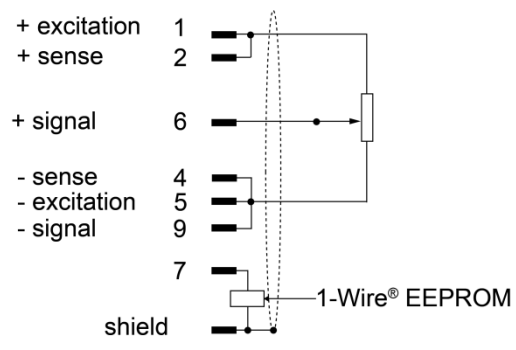
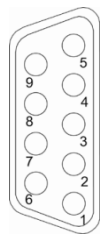

Diagram 11: Connector A: potentiometric sensors fitted with burster TEDS

4.6.2.3 Connector A: connecting standard-signal sensors

You can connect standard-signal sensors to connectors A and B.



Connector A, looking towards instrument rear (socket)

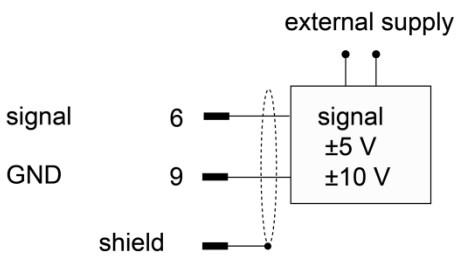
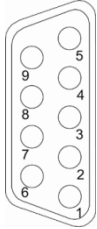

Diagram 12: Connector A: standard-signal sensors

4.6.2.4 Connector A: connecting standard-signal sensors fitted with burster TEDS

You can connect standard-signal sensors to connectors A and B.



Connector A, looking towards instrument rear (socket)

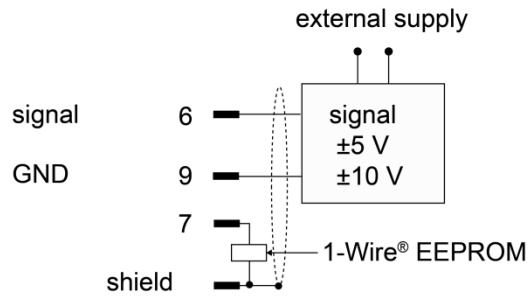

Diagram 13: Connector A: standard-signal sensors fitted with burster TEDS

4.6.3 Connector B – strain gage sensors, standard-signal sensors

	<h3>NOTICE</h3>
	<p>+5 VDC sensor excitation voltage Only connect sensors that are designed for this excitation voltage.</p>

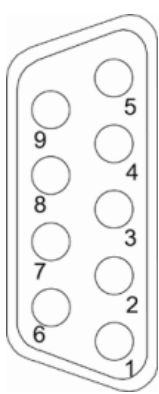

Diagram 14: Connector B

PIN	Assignment
1	+ excitation for strain gage
2	+ sense
3	not used
4	- sense
5	- excitation for strain gage
6	+ signal (input)
7	burster TEDS: 1-Wire® EEPROM
8	not used
9	- signal (input)
housing	shield (ground potential)

Note: The 1-Wire® interface uses the shield as the ground potential.

4.6.3.1 Connector B: connecting strain gage sensors without sense leads

You can connect strain gage sensors without sense leads to connector B.

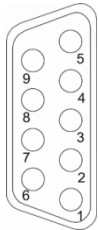

Connector B, looking towards instrument rear (socket)

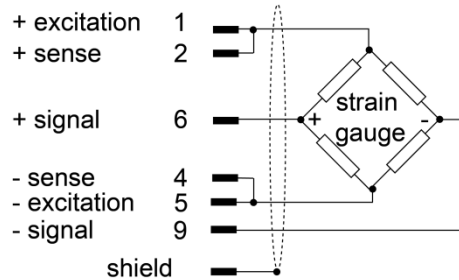
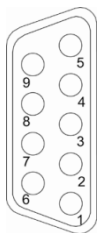

Diagram 15: Connector B: strain gage sensors without sense leads

4.6.3.2 Connector B: connecting strain gage sensors without sense leads, fitted with burster TEDS

You can connect strain gage sensors without sense leads, fitted with burster TEDS to connector B.



Connector B, looking towards instrument rear (socket)

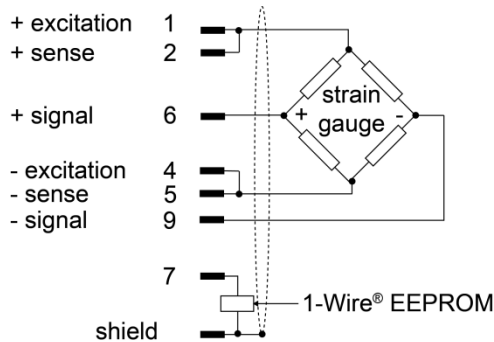
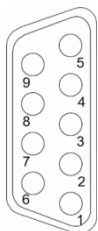

Diagram 16: Connector B: strain gage sensors without sense leads, fitted with burster TEDS

4.6.3.3 Connector B: connecting strain gage sensors with sense leads

You can connect strain gage sensors with sense leads to connector B.



Connector B, looking towards instrument rear (socket)

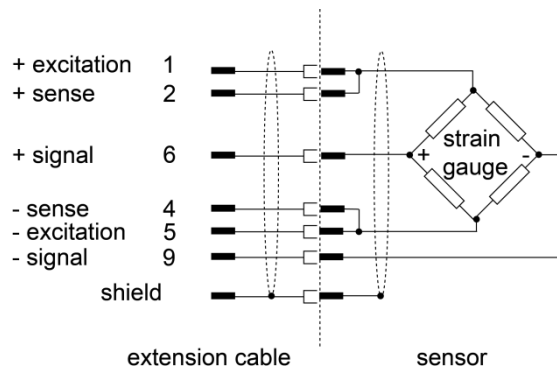

Diagram 17: Connector B: strain gage sensors with sense leads

Insert the short circuit connection between the sense lines and the excitation lines as close as possible to the sensor. For this situation, we recommend the burster extension lead, part no. 99209-609A-xxxxxxx (e.g. 099209-609A-0150030 for fixed installations, length 3 m).

DIGIFORGE® model 9311

4.6.3.4 Connector B: connecting strain gage sensors with sense leads, fitted with burster TEDS

You can connect strain gage sensors with sense leads, fitted with burster TEDS to connector B.

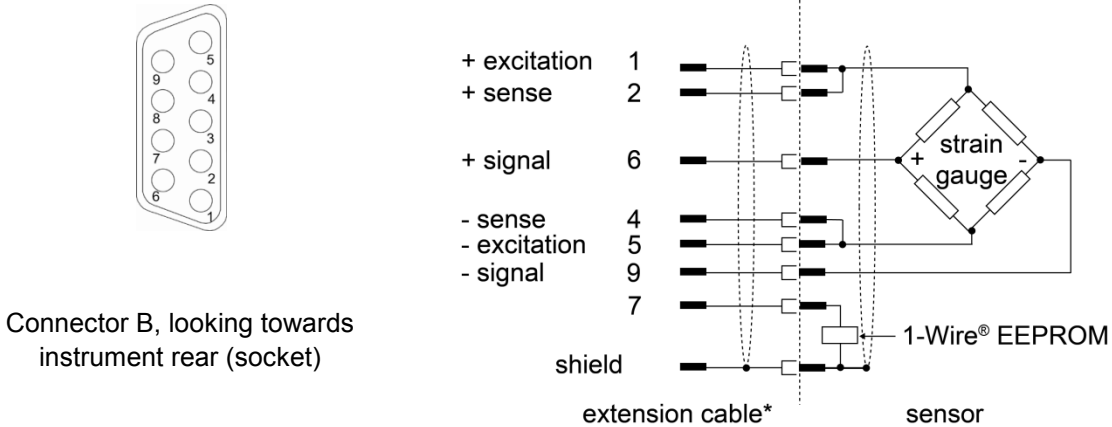

Connector B, looking towards instrument rear (socket)

Diagram 18: Connector B: strain gage sensors with sense leads, fitted with burster TEDS

*Please ensure, that the 1-Wire® signal has to be connected when using an extension cable.

4.6.3.5 Connector B: connecting standard-signal sensors

You can connect standard-signal sensors to connectors A and B.

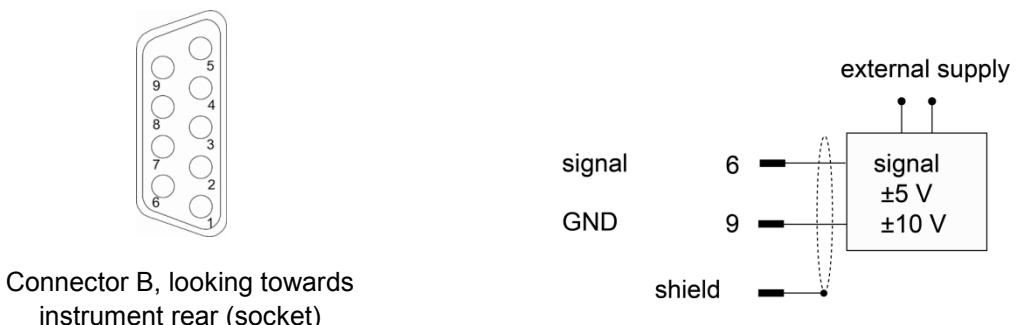

Connector B, looking towards instrument rear (socket)

Diagram 19: Connector B: standard-signal sensors

4.6.3.6 Connector B: connecting standard-signal sensors fitted with burster TEDS

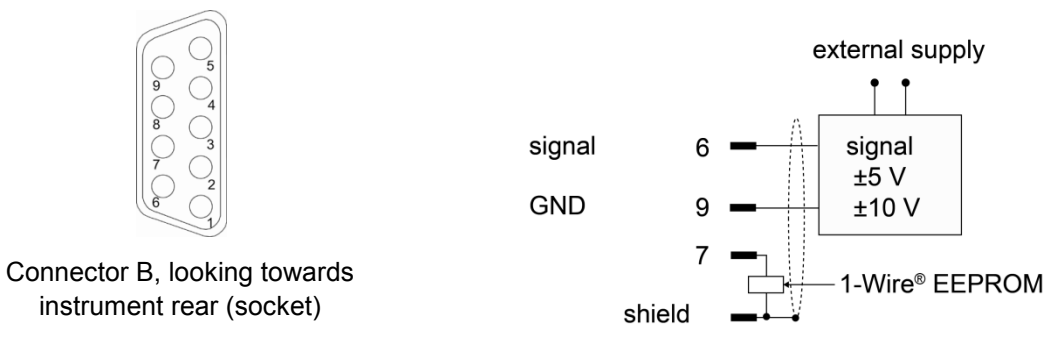

You can connect standard-signal sensors to connectors A and B.



Connector B, looking towards instrument rear (socket)

Diagram 20: Connector B: standard-signal sensors fitted with burster TEDS

4.6.3.7 Connector B: connecting a piezoelectric sensor (option)

	 WARNING
	<p>Electrostatic discharge. Do not touch!</p> <p>Electrostatic discharge can damage the piezoelectric input. Take precautionary measures against static discharge.</p>

You can connect piezoelectric sensors to connector B (standard BNC socket).

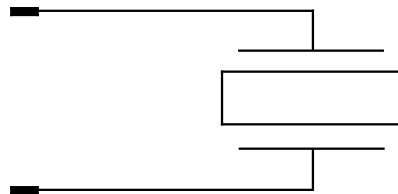
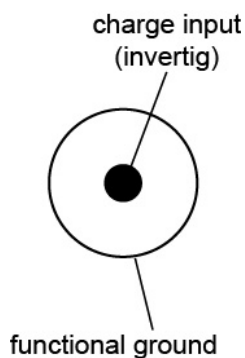

Connector B, looking towards
instrument rear (socket)

Diagram 21: Connector B: piezoelectric sensor (option)

Note: For this function, your DIGIFORCE[®] 9311 must be equipped with the optional piezoelectric input. With this option, connector B for a strain-gage or standard-signal input is no longer provided. The DIGIFORCE[®] 9311 does not support the TEDS function for the optional piezoelectric input.

DIGIFORCE® model 9311

4.6.4 USB service port

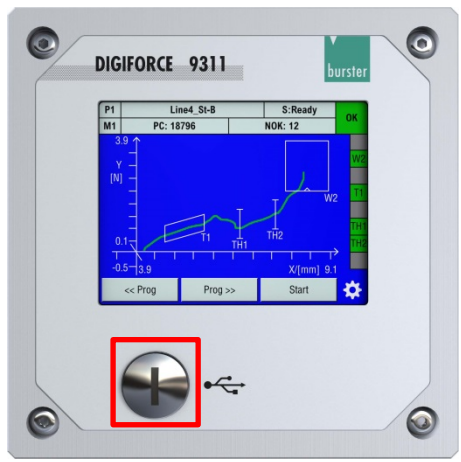

Diagram 22: Front-panel USB service port

The USB service port (micro-B) is located on the front of the instrument behind the screw-in cover. The enhanced IP degree of protection is only provided when the screw-in cover is closed.

You can use the USB service port to configure all the settings for the DIGIFORCE® 9311 and to retrieve all the measurement and evaluation results including the complete set of measurement curves. The DIGIFORCE® 9311 and DigiControl PC software (part no 9311-P101 or 9311-P100 PLUS-Version) can communicate with each other via the USB service port. Use a USB-A plug to Micro-B connecting cable (burster part number 9900-K358, length 1.8 m) to connect to a PC USB port. The protocol specification for the USB service port is provided in a separate document: "The DIGIFORCE® 9311 interface manual".

Note: The protection class IP65 is reversed, when using the USB service port on the front panel. We recommend using this USB service port for a short period only.

4.6.5 Ethernet port

You can use the Ethernet port to configure all the settings for the DIGIFORCE® 9311 and to retrieve all the measurement and evaluation results including the complete set of measurement curves. The DIGIFORCE® 9311 and DigiControl PC software (part no 9311-P101 or 9311-P100 PLUS-Version) can communicate with each other via the Ethernet port. You can specify Ethernet port parameters such as the IP address in the "Basic setup" menu (M18) (see section 6.1.10.2 "Ethernet interface parameters" on page 55).

Use a standard patch cable of category "Cat5e" or above for connecting to an Ethernet network.

The protocol specification for the Ethernet port is provided in a separate document: "The DIGIFORCE® 9311 interface manual".

4.6.6 USB host port (memory-stick data logging)

The USB host port (USB type A) is located on the rear of the instrument. When you plug in a USB flash drive and enable data logging, an entry containing result data (but not the measurement curve) is made in the plain-text *.csv file for each measurement (you can find further details in section 6.1.13 "USB flash" on page 57).

4.6.7 PROFIBUS interface

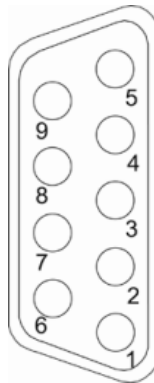

Diagram 23: PROFIBUS interface

PIN	Assignment
1	Shield
2	NC
3	RxD/TxD-P
4	NC
5	PROFIBUS GND
6	VP +5V (bus termination)
7	NC
8	RxD/TxD-N
9	NC

Details of the PROFIBUS interface are provided in a separate document: "The DIGIFORCE[®] 9311 PROFIBUS manual".

4.6.8 Ethernet-based Fieldbus interface (dual RJ45)

Details of the available Ethernet-based Fieldbus interfaces are provided in a separate document (can be obtained from info@burster.com or by phoning +49-(0)7224-645-0).

4.6.9 Instrument power plug

IEC 60320 compliant C13/C14 cold connector plug.

5 Using the instrument for the first time

	 <h3 style="margin: 0;">DANGER</h3>
<p>Electrical shock hazard</p> <p>Never switch on the instrument if it shows signs of damage incurred in transit. Only ever use the instrument under the conditions specified in this operation manual.</p>	

5.1 Panel-mounting

	<h3 style="margin: 0;">NOTICE</h3>
<p>Excessive tightening torque may result in damage.</p> <p>Overtightening may damage the mounting section.</p> <p>Use the screws supplied to cut the thread. Insert screws until they reach the surface of the mounting section. Do not exceed a torque of 0.7 Nm when tightening the screws "F" with precut thread.</p>	

5.1.1 Panel-mounting

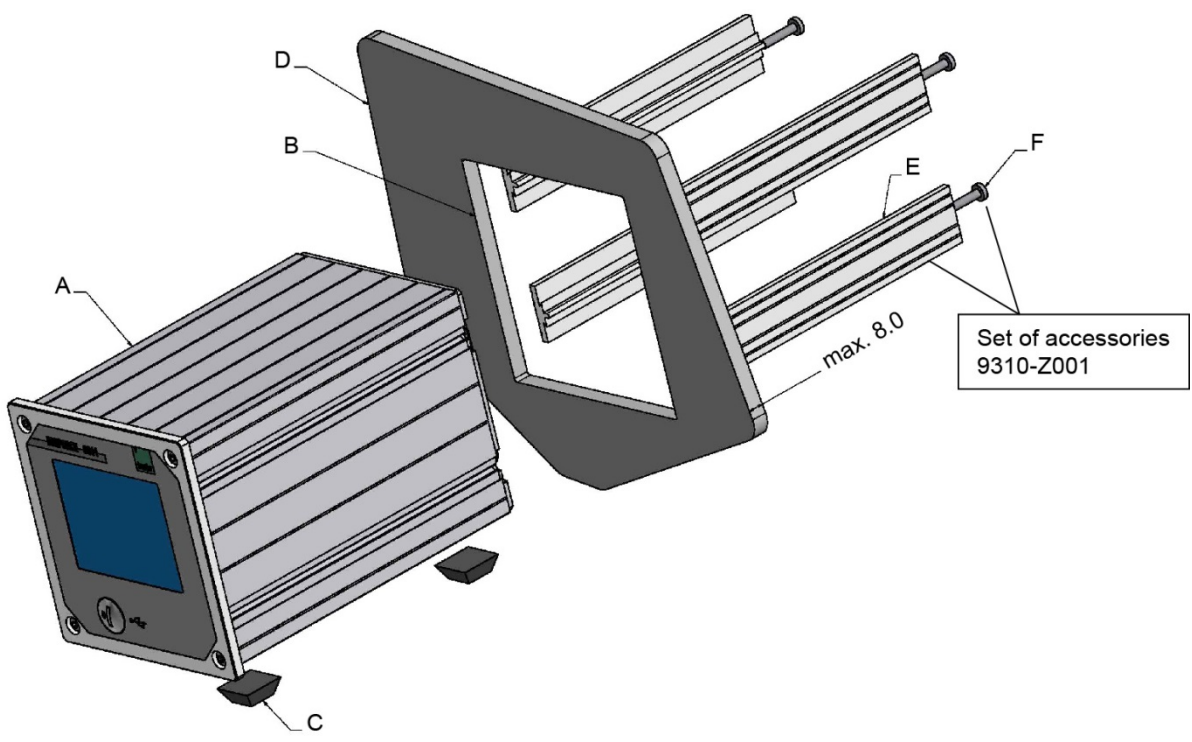

Diagram 24: Panel-mounting the DIGIFORCE® 9311

Label	Description
A	DIGIFORCE® 9311
B	Case cutout
C	Self-adhesive feet (remove before fitting)
D	Instrument panel
E	Mounting sections (x4)
F	Self-tapping Torx screws (x4) M4x20

5.1.2 Panel cutout

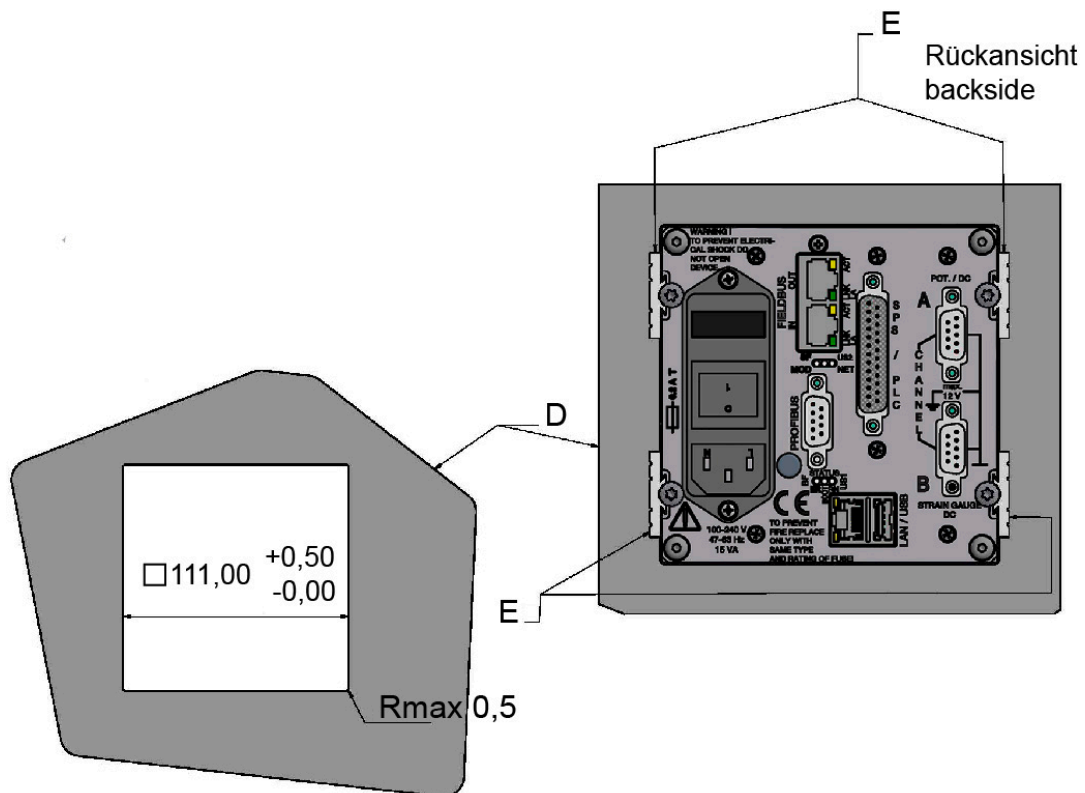

Diagram 25: Panel cutout for the DIGIFORCE® 9311

5.2 User language and diagnostics

Immediately after power-up, the DIGIFORCE[®] 9311 runs a self-test for about 5 seconds. During this self-test, you have the chance to change the user language or go directly to the diagnostics menu (M44) if you wish. The set user language is displayed as a national flag in the top right of the screen during the self-test.



This is how it works

- 1 Switch on the instrument at the mains switch.
- 2 After a short boot-up phase, the self-test starts running. During the self-test, if you wish to set the user language then tap either **[Config]** or the flag in the top-right corner; to open the diagnostics menu tap **[Diagnosis]**.

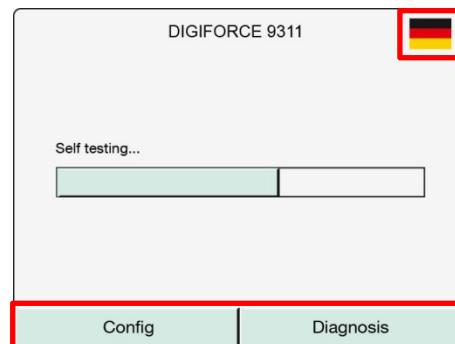

- 3 Tapping **[Config]** takes you directly to the "Configuration Main Menu". Tap the "Basic setup" icon.
- 4 Tap the "Language" icon.
- 5 Tap the displayed flag.
- 6 Select the flag for the language you require.
- 7 Tap  3 times to return to measurement mode.



For further information on the user language and diagnostics, please see section 6.1.9 "Language" on page 53 or section 6.1.15 "Diagnostics" on page 63.

6 Configuring the instrument - "Configuration Main Menu"

Instrument settings for the DIGIFORCE® 9311 are configured via the "Configuration Main Menu" (M7).



This is how it works

- 1 Once powered-up, the DIGIFORCE® 9311 enters measurement mode directly; to access the configuration settings for the instrument, touch any point on the touchscreen. The  icon appears in the bottom-right corner.
- 2 Tap  to open the "Configuration Main Menu".

Note: You can choose to display the  icon permanently in measurement mode. For further details, please see section 6.1.1 "Function key definition" on page 44.

Menu structure

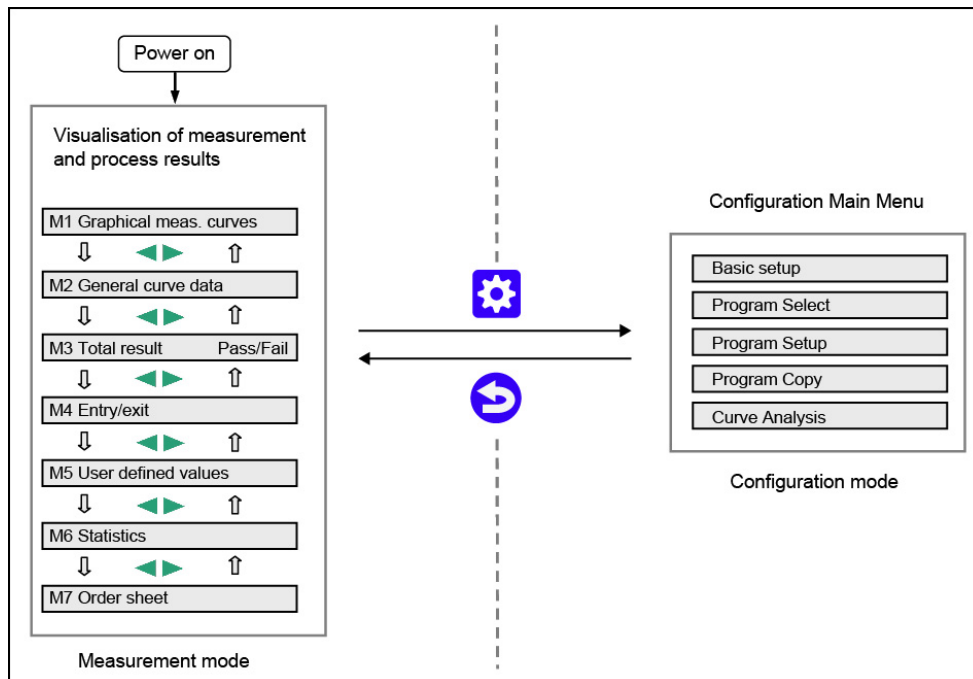

Diagram 26: The DIGIFORCE® 9311 menu structure

Note: Simply tap  several times from any submenu to return to measurement mode.

IMPORTANT: Access to the configuration level may be blocked in the following cases:

- PLC control signal "IN_AUTO" = 1.
- Access protection is enabled (please see section 6.1.4 "Access permissions" on page 49).
- DigiControl measurement mode is active (automatic logging of measurement data by the DigiControl PC software).

Configuration Main Menu (M7)

The following submenus are available in the "Configuration Main Menu" (M7):



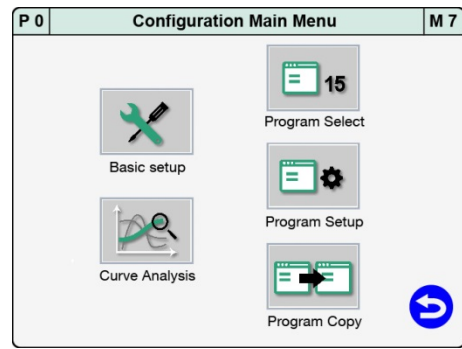











- Basic setup
- Program selection
- Program setup
- Copy programs
- Curve Analysis

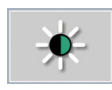

6.1 Basic setup



The "Basic setup" menu (M18) contains all the settings that do not relate specifically to measurement programs.

You can edit or view the following settings and information in the "Basic setup" menu (M18):

	Function key definition		PLC outputs		PLC inputs
	Access authorisation		Measurement menus		Info
	LCD settings		Date and time		Language
	Interfaces		Acknowledge function		Order sheet
	USB flash		Channel settings		Diagnostics



This is how it works

- 1 To open the "Basic setup" menu from measurement mode, tap anywhere on the touchscreen. The  icon appears in the bottom-right corner.
- 2 Tap  to open the "Configuration Main Menu".
- 3 Tap the "Basic setup" icon.

Note: You can choose to display the  icon permanently in measurement mode. For further details, please see section 6.1.1 "Function key definition" on page 44.

6.1.1 Function key definition

The "Function key definition" menu (M36) lets you customize the three function keys displayed in measurement mode, and to select whether they are displayed permanently or only temporarily for 5 seconds.

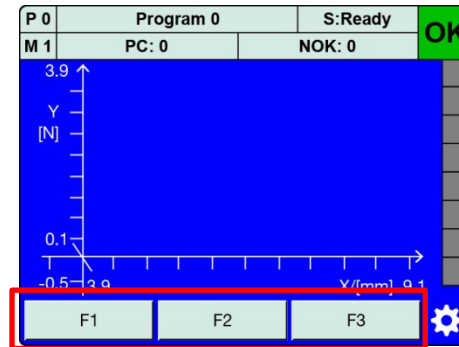



The following functions can be assigned:

Description	Assignment
Off	Not used
Program >>	Switch to the next program in measurement mode
Program <<	Switch to the previous program in measurement mode
Tare X	Tare the X-channel
Tare Y	Tare the Y-channel
Start/Stop	Start a measurement / Stop a measurement
Acknowledge OK-parts	Acknowledge parts that are OK (Acknowledgement function)
Acknowledge NOK-parts	Acknowledge parts that are NOK (Acknowledgement function)
Sensor test	Perform sensor test
Edit mode	Enable edit mode*

*You can use Edit mode to switch the DIGIFORGE[®] 9311 into the configuration level and edit parameters even while the DigiControl software is actively logging data.



This is how it works

- 1 In measurement mode, tap anywhere on the touchscreen. The  icon appears in the bottom-right corner.
- 2 Tap  to open the "Configuration Main Menu".
- 3 Tap the "Basic setup" icon.
- 4 Tap the "Function Keys" icon.
- 5 Tap the function key (F1, F2, F3) that you want to assign.
- 6 Select the function you wish to assign then confirm with **[ENTER]**.
- 7 If you want to change how long the function keys are displayed, tap "Display mode".
If "Always on" is enabled, then the function keys are permanently displayed in measurement mode.
If "Fade out" is enabled, then you can display the function keys for 5 seconds in measurement mode by tapping anywhere on the touchscreen.
- 8 Tap  to return to the "Basic setup" menu.

6.1.2 PLC outputs



In the menu "Assignment of the PLC outputs" (M37), you can customize which signals appear at certain PLC outputs. You cannot change the settings for pins 12 and 14 to 19.

You have the option to assign a different signal to pins 20 to 25 from the following:

Signal	Description
OUT_OK_STEST	Sensor test OK
OUT_STROBE	Validity signal for echoed measurement program number
OUT_PROG0	Bit 0 of echoed measurement program number
OUT_PROG1	Bit 1 of echoed measurement program number
OUT_PROG2	Bit 2 of echoed measurement program number
OUT_PROG3	Bit 3 of echoed measurement program number
OUT_MEAS_ACT	Measurement in progress (measurement active)
OUT_S3	Switching signal S3
OUT_S4	Switching signal S4
OUT_S5	Switching signal S5
OUT_S6	Switching signal S6
OUT_TEST_OP	The 9311 is in test mode
OUT_ERROR	Fault / error Possible causes: <ul style="list-style-type: none"> • Measurement started when READY = 0 • Measurement-channel overdrive • Device error during boot-up
OUT_WARN_TARE	Warning that tare limit reached
OUT_CONFIG	The 9311 is in configuration mode
OUT_ACK_ALARM	Alarm output from Acknowledgement function
OUT_ACK_LOCK	Lock output from Acknowledgement function
OUT_ACK_OK	OK output from Acknowledgement function
OUT_ACK_NOK	NOK output from Acknowledgement function
OUT_PC_LOG	Data logging on PC (DigiControl measurement mode enabled)



This is how it works

- 1 In measurement mode, tap anywhere on the touchscreen. The  icon appears in the bottom-right corner.
- 2 Tap  to open the "Configuration Main Menu".
- 3 Tap the "Basic setup" icon.
- 4 Tap the "PLC outputs" icon.
- 5 To open the second page of the menu, tap the bottom of the scroll bar.
- 6 Tap the name of the pin that you wish to reassign.
- 7 Select the signal that you wish to assign then confirm with **[ENTER]**.
- 8 Repeat steps 4 and 5 for all the pins that you wish to reassign.
- 9 Tap  to return to the "Basic setup" menu.

6.1.3 PLC inputs

In the menu "Assignment of the PLC inputs" (M79), you can customize which signals are assigned to certain PLC inputs. You cannot change the settings for pins 3, 7 to 11 and 13.



You have the option to assign a different signal to pins 4, 5 and 6 from the following:

Signal	Description
IN_TARE_X	Tare the X-channel
IN_TARE_Y	Tare the Y-channel
IN_TARE_X+Y	Tare the X-channel and Y-channel
IN_RES_STAT	Reset the statistics
IN_STEST	Run the sensor test
IN_TEST_OP	Switch to Graphical test operation (measurement / evaluation without counter)
IN_ACK	Acknowledgement function – acknowledgement of OK and NOK evaluations
IN_ACK_OK	Acknowledgement function – acknowledgement of OK evaluations
IN_ACK_NOK	Acknowledgement function – acknowledgement of NOK evaluations
IN_ACK_ERROR	Acknowledgement of errors/faults (when "OUT_ERROR" = 1)*

*If the DIGIFORGE[®] 9311 has a permanent error, the "OUT_ERROR" output cannot be reset by acknowledging the error.



This is how it works

- 1 In measurement mode, tap anywhere on the touchscreen. The  icon appears in the bottom-right corner.
- 2 Tap  to open the "Configuration Main Menu".
- 3 Tap the "Basic setup" icon.
- 4 Tap the "PLC inputs" icon.
- 5 Tap the name of the pin that you wish to reassign.
- 6 Select the signal that you wish to assign then confirm with **[ENTER]**.
- 7 Repeat steps 3 and 4 for all the pins that you wish to reassign.
- 8 Tap  to return to the "Basic setup" menu.

6.1.4 Access permissions

You can make the following settings in the "Access authorisation" menu (M39):



- Define/change a master password
- Define/change a user password
- Enable/disable password protection
- Specify access levels for master/user
- Blocking/unblocking access by DigiControl PC software

Factory-set master password	2609
Factory-set user password	2201

Changing the master/user password



This is how it works

- 1 In measurement mode, tap anywhere on the touchscreen. The  icon appears in the bottom-right corner.
- 2 Tap  to open the "Configuration Main Menu".
- 3 Tap the "Basic setup" icon.
- 4 Tap the "Access" icon.
- 5 Tap "Master password" and enter the current password via the keypad.
- 6 Tap **[OK]**.
- 7 Tap "New master password" and enter the new password you require via the keypad.
- 8 Tap **[OK]**.
- 9 Tap "User password" and enter the current password via the keypad.
- 10 Tap **[OK]**.

Specifying access levels for master/user

The DIGIFORCE[®] 9311 lets you manage the master/user access levels. When password protection is enabled, you can lock specific configuration levels for the currently logged-in user. A master assumes the role of an administrator for the instrument and has access rights to all levels. A master is also able to set the permissions for the user and for a user password.

The following levels can be locked/unlocked for the logged-in user:

- Basic setup
- Program selection
- Copy programs
- Curve analysis
- Channel settings
- Measurement mode
- Evaluation
- Switching points
- Test Operation
- Sensor test
- User-defined values
- USB flash



This is how it works

- 1 After entering the master password, tap "Password protection" to enable this option.
- 2 Tap "Access levels".
- 3 Select the access levels that you want to lock.
- 4 Tap  to return to the "Access authorisation" menu.

Blocking/unblocking access by the DigiControl PC software

In the "Access authorisation" menu (M39), with password protection enabled you also have the option to block the DigiControl PC software from making changes to the instrument configuration. To do this, disable the "Access DigiControl" checkbox (even with password protection enabled, the default setting is to allow access by the DigiControl PC software).



This is how it works

- 1 Tap the checkbox to allow or block access by DigiControl
- 2 Tap  to return to the "Basic setup" menu.

6.1.5 Measurement menus



In the "Measurement menu display control" menu (M41), you can specify which of the process views (up to 7 available) are displayed in measurement mode (for details, please see chapter 7 "Measurement results display - Measurement mode" on page 186). In this menu you can also enable the display of sensor live values in measurement mode.

You can enable or disable the following measurement menus:

- M1 Graphical measurement curve
- M2 General curve data
- M3 Total result (overall result indicated by Smiley or Pass/Fail)
- M4 Entry/Exit
- M5 User-defined values
- M6 Statistics
- M7 Order sheet



This is how it works

- 1 In measurement mode, tap anywhere on the touchscreen. The  icon appears in the bottom-right corner.
- 2 Tap  to open the "Configuration Main Menu".
- 3 Tap the "Basic setup" icon.
- 4 Tap the "Measmnt menus" icon.
- 5 Tap the checkbox of those measurement menus (M1 to M7) that you want displayed.
- 6 To display the sensor live values, first enable the checkbox "M1 Graphical meas. curves". The "Show live values" checkbox is then additionally available for you to enable. You can then see the sensor live values displayed in measurement mode.
- 7 Tap  to return to the "Basic setup" menu.



Note: It is not possible to display the sensor live values and the function keys simultaneously at the bottom of the touchscreen. You can, however, show the enabled function keys for about 5 seconds by tapping the touchscreen.

6.1.6 Instrument information

The "Device information" menu (M20) contains information about the instrument, including serial number, software version, bootloader version, sensor electronics, calibration date and Fieldbus card. In this menu you can also enter a station name and reset the statistics and part counter, either for all programs or just the current program.



This is how it works



- 1 In measurement mode, tap anywhere on the touchscreen. The  icon appears in the bottom-right corner.
- 2 Tap  to open the "Configuration Main Menu".
- 3 Tap the "Basic setup" icon.
- 4 Tap the "Info" icon.
- 5 To open the second page of the menu, tap the bottom of the scroll bar.
- 6 Tap "Station name" and enter the name you require via the keypad.
- 7 Tap **[OK]**.
- 8 Tap "Reset statistics, all programs" to reset the statistics for all programs. Tap "Reset statistics, current prog." to reset the statistics only for the current program.
- 9 Tap **[ENTER]** to perform the reset or tap **[ESC]** to cancel the reset.
- 10 Tap  to return to the "Basic setup" menu.

6.1.7 LCD setting

In the "LCD setup" menu (M34) you can set the brightness of the touchscreen display in 10 levels.



This is how it works



- 1 In measurement mode, tap anywhere on the touchscreen. The  icon appears in the bottom-right corner.
- 2 Tap  to open the "Configuration Main Menu".
- 3 Tap the "Basic setup" icon.
- 4 Tap the "LCD setup" icon.
- 5 Tap **[+]** or **[-]** to step up or step down the brightness.
- 6 Tap  to return to the "Basic setup" menu.

6.1.8 Date and time

In the "Date and time" menu (M47) you can set the date and time.



This is how it works

- 1 In measurement mode, tap anywhere on the touchscreen. The  icon appears in the bottom-right corner.
- 2 Tap  to open the "Configuration Main Menu".
- 3 Tap the "Basic setup" icon.
- 4 Tap the "Time/date" icon.
- 5 Tap the text field that you wish to change.
- 6 Make the change via the keypad and tap **[OK]**.
- 7 Tap  to return to the "Basic setup" menu.

6.1.9 Language



In the "Language selection" menu (M60) you can set the user language for the DIGIFORCE[®] 9311.

The following 6 languages are available:

- German
- English
- French
- Italian
- Spanish
- Chinese (only the measurement menus in measurement mode)



This is how it works

- 1 In measurement mode, tap anywhere on the touchscreen. The  icon appears in the bottom-right corner.
- 2 Tap  to open the "Configuration Main Menu".
- 3 Tap the "Basic setup" icon.
- 4 Tap the "Language" icon.
- 5 Tap the displayed flag.
- 6 Select the flag for the language you require.
- 7 Tap  to return to the "Basic setup" menu.





6.1.10 Interfaces

In the "Interface setup (USB/Ethernet)" menu (M48) you can specify the necessary interface parameters.

Note: If the DIGIFORCE[®] 9311 is incorporated in live measurement-data logging by the DigiControl PC software via one of the two interfaces (USB or Ethernet) (measurement mode), the DigiControl PC software cannot have parallel access via the second interface.



This is how it works

- 1 In measurement mode, tap anywhere on the touchscreen. The  icon appears in the bottom-right corner.
- 2 Tap  to open the "Configuration Main Menu".
- 3 Tap the "Basic setup" icon.
- 4 Swipe  the touchscreen to open the second page.
- 5 Tap the "Interfaces" icon.
- 6 Tap the icon for the interface ("USB" or "Ethernet") for which you want to specify the interface parameters, then make the required settings.
- 7 Tap  to return to the "Basic setup" menu.

6.1.10.1 USB interface parameters

A PC detects the USB port of the DIGIFORCE[®] 9311 as a virtual COM port. The drivers needed for this port are installed with the DigiControl PC software. If you want to use PC communication without the DigiControl PC software, you can install the necessary drivers from the DVD supplied (the drivers are also available from www.burster.com).

Parameters in the "Interface setup (USB/Ethernet)" menu (M51)

Baud rate	921600 (fixed setting)
Data bits	Fixed data format, 8 bits (fixed setting)
Stop bits	Number of stop bits: 1 (fixed setting)
Parity	None (fixed setting)
Blockcheck*	Enabled / disabled

*The separate Interface specification provides information on the block check.

6.1.10.2 Ethernet interface parameters

Parameters in the "Ethernet interface (UDP/IP)" menu (M50)

DHCP	<p>Enabled / disabled</p> <p>When DHCP is enabled (Dynamic Host Configuration Protocol), the DIGIFORCE[®] 9311 is assigned an IP address, subnet mask and gateway by the DHCP server.</p>
IP address	<p>Enter here the IP address for the DIGIFORCE[®] 9311. You can obtain a valid address from your network administrator.</p> <p>Note: The IP address must be unique within a network.</p>
Subnet mask	<p>Enter the subnet mask here. You can obtain a valid mask from your network administrator. The subnet mask defines whether an IP address lies in the same sub-network.</p>
Gateway	<p>Enter the gateway here. You can obtain a valid address from your network administrator. Connections to other networks can be made via the gateway.</p>
Port	<p>This is where you select the UDP port (default: 7292).</p> <p>Note: If a firewall is used, the UDP protocol must be enabled on this port. On a PC, only one active UDP connection (socket) is allowed on the same port.</p>
Communication	<p>Ethernet communication. Select either "Encoded" or "Encoded and open".</p> <p>"Encoded": UDP datagrams are transmitted in encoded form.</p> <p>"Encoded and open": UDP datagrams are transmitted in encoded and un-encoded form.</p>
MAC address	<p>Shows the unique MAC address</p>
Host IP restriction	<p>An active Host IP restriction can be used to restrict access to up to three specified host addresses. This can be useful for preventing unwanted access attempts, for example attempts to change the instrument configuration. The Host IP restriction is factory set to disabled.</p>

6.1.11 Acknowledgement function

In the "Acknowledgement function" menu (M33), you can configure the use of indicator lights and an acoustic signal. You can also specify here that operating personnel must confirm NOK/OK parts. This function is linked to the "OUT_ACK_LOCK" lock output. The DIGIFORGE® 9311 can use this lock, for instance, to stop the stroke of a manual press in the event of an NOK evaluation. You can use the [-] and [+] buttons below "Buzzer volume" to set the volume level of the external acoustic signal.

You can use the following PLC outputs for the Acknowledgement function:

OUT_ACK_OK	Signal for the external "Pass indicator" (measurement OK) If the acknowledgement function for OK parts is enabled, the signal flashes until acknowledged. In addition the message "S:Acknowledge!" is displayed on the touchscreen. Acknowledgement sets the PLC output to active (does not flash).
OUT_ACK_NOK	Signal for the external "Fail indicator" (measurement NOK) If the acknowledgement function for NOK parts is enabled, the signal flashes until acknowledged, and the OUT_BUZZER is activated. In addition the message "S:Acknowledge!" is displayed on the touchscreen. On acknowledgement, the PLC output OUT_ACK_NOK is set to active (stops flashing) and the buzzer output is deactivated.
OUT_ACK_LOCK	Lock output, e.g. to be used externally to prevent a return stroke
OUT_ACK_ALARM	If the acknowledgement function is enabled and the acknowledge is performed incorrectly, the alarm output is set.
OUT_BUZZER	PWM signal for an external acoustic signal



If the acknowledgement function is enabled, it can be useful to assign the acknowledge action to the function keys (see section 6.1.1 "Function key definition" on page 44) or to the PLC inputs:

IN_ACK_OK	Acknowledge input for the "Pass indicator" (measurement OK)
IN_ACK_NOK	Acknowledge input for the "Fail indicator" (measurement NOK)
IN_ACK	Acknowledge input for OK and NOK measurements

Note: You can also find further details on the signal sequences in section 8.5 "Acknowledgement function" on page 206.



This is how it works

- 1 In measurement mode, tap anywhere on the touchscreen. The  icon appears in the bottom-right corner.
- 2 Tap  to open the "Configuration Main Menu".
- 3 Tap the "Basic setup" icon.
- 4 Tap the "ACK Function" icon for the Acknowledgement function.
- 5 Enable the checkbox by tapping "Ack function".
- 6 Enable the acknowledgement functions you require by tapping on the relevant checkboxes under "Ack OK" and "Ack NOK".
- 7 Tap the [+] or [-] buttons below "Buzzer volume" to step up or step down the volume.
- 8 Tap  to return to the "Basic setup" menu.



6.1.12 Order sheet

In the "Order sheet" menu (M52) you can save and retrieve a huge range of background information on the measurement. All entries can be read/written via the available Fieldbus interfaces. The DigiControl PC software can optionally retrieve these entries during automatic logging of measurement data, and use them to create a reference to admin, operator or component in the measurement report file.

- Name of operator
- Order number
- Batch
- Component name
- Serial number 1
- Serial number 2

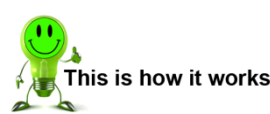
You can visualize the order sheet in measurement mode. For further information on the order sheet, please see section 7.8 "M7 Order sheet" on page 194.



- 1 In measurement mode, tap anywhere on the touchscreen. The  icon appears in the bottom-right corner.
- 2 Tap  to open the "Configuration Main Menu".
- 3 Tap the "Basic setup" icon.
- 4 Tap the "Order Sheet" icon.
- 5 Tap the line that you want to edit and then enter the required information via the keypad.
- 6 Tap [OK].
- 7 Tap  to return to the "Basic setup" menu.

6.1.13 USB flash

When data logging on a USB flash drive is enabled, a data entry containing result data (but not the measurement curve) is made for each measurement. If you have connected a USB flash drive to the rear USB port of the DIGIFORCE® 9311, the associated information is displayed in the "USB flash" menu (M81). In this menu you can also format the USB flash drive, select the source of the component name and configure the behaviour of the "OUT_READY" control signal.

The following settings can be made in the "USB flash" menu (M81):

USB flash	Format the memory (data format: FAT32)
Designation	Here you can choose whether the program name or order sheet is used as the designation. This designation is used for subsequent identification of the measurement and appears both in the name of the *.csv file on the USB flash drive and inside the file in the "HEADER" as the component name ("Component").
READY control	If you enable this function, the Ready status and the "OUT_READY" control signal is not set until data logging on the USB stick has finished.

Note: You need to enable data logging in each measurement program for which you wish to record the measurement data on USB. For further details, please see section 6.3.9 "USB flash" on page 176.

Procedure

With USB flash drive data logging enabled, a data entry is made for each measurement. A new file is created when USB flash drive data logging first starts. When the file is created, a "HEADER" is saved in the file. This header is not subsequently checked for plausibility however. The file name, on the other hand, is always checked for validity for subsequent measurements. If it is still valid, the new entry is added to the file. If not, a new file is created. If the file reaches the maximum file size of 25 MB, data is automatically written to a new file.

Storage location	...\\Data\\<YYYY>\\<MM>\ Key: <YYYY> : year <MM> : month
File type	*.csv (ASCII)
Language	English language only
File name	<Component_Name>~<Batch>#<Sequential_Number> @<9311_Serial_Number><Program_Number>.csv Key: <Component_Name> : Configurable; program name, or component name from order sheet. ~<Batch> : Batch from order sheet; not included if a batch reference is not entered. #<Sequential_Number> : A sequential number with "#" prefix for files with the same name; not used if the file name is unique.
Maximum file size	25 MB

DIGIFORCE® model 9311

File structure - HEADER

Note: The "HEADER" is created just once when the file is created, but not checked again for plausibility.

The "HEADER" contains the following information:

	A	B
1	HEADER	
2	Station name	ST-A-70
3	Device Serial number	931106
4	Component	Lager-N762
5	Meas. Prog-Name	PROG 0
6	Meas-Prog-No.	0
7	Batch	Z987654321A
8	Unit X	mm
9	Unit Y	N
10	Time stamp	2016_02_19_15_14_34
11	FW/Protocol vers.	V201606B/1.01

Diagram 27: "HEADER" screenshot

Station name	Station name
Device Serial number	Serial number of the DIGIFORCE® 9311
Component	Component name (if given in the order sheet)
Meas.-Prog-Name	Name of the measurement program
Meas.-Prog-No.	Number of the measurement program
Batch	Batch reference from the order sheet
Unit X	Units for the X-axis
Unit Y	Units for the Y-axis
Time stamp	File-creation date and time stamp (YYYY_MM_DD_hh_mm_ss)
FW/Protocol vers.	Firmware and version code for data logging on USB stick

File structure - data area

The following data entry is generated for each measurement:

- Date / Time
- Overall result OK/NOK (including code of source of NOK result)
- Serial number (from the order sheet)
- Part counter
- "General curve data" dataset (2 x 7 floating point values)
- "User-defined values" dataset (up to 20 floating point values)

Date / Time	<p>Time stamp for the measurement Format: YYYY-MM-DD hh:mm:ss; Terminating character: semicolon ";" (0x3B hex) Example: 2016-02-25 18:02:46;</p>																
Result	<p>Overall result of the measurement, OK/NOK, including individual results from the graphical evaluation elements: You can configure up to 8 graphical evaluation elements in one measurement program. In measurement mode, the individual evaluation results indicate the associated element (see section 7.1.4 "Individual evaluation status in measurement mode" on page 188). Each of these 8 items is given a value in the *.csv file: 0 = active and evaluated as OK, 1 = active and evaluated as NOK, and - = inactive Terminating character: semicolon ";" (0x3B hex) Example:</p> <table border="1" data-bbox="584 1283 906 1787"> <tr> <td style="background-color: green; color: white;">W1</td> <td>active and OK (0)</td> </tr> <tr> <td style="background-color: gray;"> </td> <td>inactive (-)</td> </tr> <tr> <td style="background-color: gray;"> </td> <td>inactive (-)</td> </tr> <tr> <td style="background-color: red; color: white;">Tr1</td> <td>active and NOK (1)</td> </tr> <tr> <td style="background-color: gray;"> </td> <td>inactive (-)</td> </tr> <tr> <td style="background-color: green; color: white;">Th1</td> <td>active and OK (0)</td> </tr> <tr> <td style="background-color: green; color: white;">Th2</td> <td>active and OK (0)</td> </tr> <tr> <td style="background-color: red; color: white;">EN</td> <td>active and NOK (1)</td> </tr> </table> <p>OK (0--0-000); : OK measurement (W1, Tr1, Th1, EN active and OK) NOK (0--1-001); : NOK measurement (Tr1 and EN are source of NOK)</p>	W1	active and OK (0)		inactive (-)		inactive (-)	Tr1	active and NOK (1)		inactive (-)	Th1	active and OK (0)	Th2	active and OK (0)	EN	active and NOK (1)
W1	active and OK (0)																
	inactive (-)																
	inactive (-)																
Tr1	active and NOK (1)																
	inactive (-)																
Th1	active and OK (0)																
Th2	active and OK (0)																
EN	active and NOK (1)																
Serial number	<p>This entry is obtained from "SN1" on the order sheet. Note: Information can be entered in the order sheet via the Fieldbus interfaces. Terminating character: semicolon ";" (0x3B hex)</p>																



DIGIFORCE[®] model 9311

Part counter	Part counter in the DIGIFORCE [®] 9311 Terminating character: semicolon ";" (0x3B hex)
General curve data	"General curve data" dataset Xmin, Xmax, Ymin, Ymax, Start, End and Return point, each as a pair of coordinates Delimiting character: " " (0x7C hex) Terminating character: semicolon ";" (0x3B hex)
User-defined values	"User-defined values" dataset (see section 6.3.8 "User-defined values" on page 173). Delimiting character: " " (0x7C hex) Terminating character: Line Feed "LF" (0x0A hex)

Note: If you require an example of a USB-stick data-logging file, please email info@burster.com.



This is how it works

- 1 In measurement mode, tap anywhere on the touchscreen. The  icon appears in the bottom-right corner.
- 2 Tap  to open the "Configuration Main Menu".
- 3 Tap the "Basic setup" icon.
- 4 Tap the "USB flash" icon.
- 5 Tap the line that you wish to change until the setting you require is displayed.
- 6 Tap  to return to the "Basic setup" menu.



6.1.14 Channel settings

In the "Channel settings" menu (M83), you can choose whether you want the channel settings to apply to all the measurement programs ("globally"), or specifically to each measurement program ("program depending"). For further details on the possible channel settings, please refer to section 6.3.1 "Channel settings" on page 71.

Note: The factory-set default is "globally".



This is how it works

- 1 In measurement mode, tap anywhere on the touchscreen. The  icon appears in the bottom-right corner.
- 2 Tap  to open the "Configuration Main Menu".
- 3 Tap the "Basic setup" icon.
- 4 Tap the "Channel Setup" icon.
- 5 Tap "Channel Setup" to switch between "program depending" and "globally".
If you have selected the "program depending" option, when making channel settings you must start afresh for each measurement program. If you have selected "globally", the channel settings for one measurement program are adopted for all the other measurement programs.
- 6 Tap  to return to the "Basic setup" menu.

IMPORTANT: If you close the menu when "globally" is set, all the previous program-specific channel settings are lost. The settings from the currently set measurement program are then copied to all the other programs.

6.1.15 Diagnostics

The "Diagnosis Menu" (M44) contains 3 submenus.



Log File



Voltage



Service Login

The "Log file analyzing" menu (M57) contains the following details: Entry number, Event, Date, Time, Program number, Access authorization and Repetitions for each of the 256 log entries.



The following events are recorded in the Log File:

- "Memory error detected"
- "Voltage supply error detected"
- "PLC driver error detected"
- "Analog board EEPROM error detected"
- "Tare warning limit reached"
- "Start/Stop without measurement"
- "Channel X overdrive"
- "Channel Y overdrive"
- "Measurement storage overflow"
- "Start of measurement without READY"
- "Change of circuit board MainAnalog"
- "Device power up"
- "Error on communication interface"
- "Unauthorized access ComInterface"
- "Software update"
- "Menu: X channel settings"
- "Menu: Y channel settings"
- "Menu: Measurement mode"
- "Menu: Evaluation - Window"
- "Menu: Evaluation - Trapezoid window"
- "Menu: Evaluation - Thresholds"
- "Menu: Evaluation - Envelopes"
- "Main menu: Evaluation"
- "Menu: Assignment of PLC outputs"
- "Menu: Assignment of PLC inputs"
- "Menu: USB interface"
- "Menu: Ethernet interface"
- "Initialize target program(s)"
- "Copy sensor setup"
- "Copy whole setup"
- "Setup realtime switchpoints"

The "Voltage monitor" menu (M67) contains the values for Node voltage, Excitation A, Excitation B and GND potential. The "Service Login" menu is password-protected and reserved for employees of burster praezisionsmesstechnik gmbh & co kg.



This is how it works

- 1 In measurement mode, tap anywhere on the touchscreen. The  icon appears in the bottom-right corner.
- 2 Tap  to open the "Configuration Main Menu".
- 3 Tap the "Basic setup" icon.
- 4 Tap the "Diagnostics" icon.
- 5 Tap the relevant icon to display the information you require.
- 6 Tap  twice to return to the "Basic setup" menu.

6.1.16 PROFIBUS settings (option)

Note: The "PROFIBUS" menu (M54) only exists if your DIGIFORCE[®] 9311 is installed with option Vxxx2.

P 0	PROFIBUS	M54
SW-version	PB-V201600	
Serial number	01234567	
Control via	PLC	
Station address	2	
Cyclic data	----	
		

Diagram 28: PROFIBUS settings

Parameters in the "PROFIBUS" menu (M54)

SW version	Firmware version of the PROFIBUS Fieldbus module
Serial number	Serial number of the Fieldbus module
Control via	<p>PROFIBUS: the DIGIFORCE[®] 9311 responds solely to control signals (inputs) from the PROFIBUS interface.</p> <p>PLC: the DIGIFORCE[®] 9311 responds solely to control signals (inputs) from the PLC I/O interface.</p> <p>When control via PLC I/O is selected, data is still transferred using the cyclical PROFIBUS DP-V0 protocol.</p>
Station address	<p>Enter here the PROFIBUS address for the instrument.</p> <p>Valid address range: 1 to 126.</p>
Cyclical data	<p>Displays the active mode in the cyclical PROFIBUS DP-V0 service.</p> <p>Details are provided in a separate document: The DIGIFORCE[®] 9311 PROFIBUS manual.</p>

Note: Details of the PROFIBUS interface are provided in a separate document: "The DIGIFORCE[®] 9311 PROFIBUS manual".

6.1.17 PROFINET settings (option)

Note: The "PROFINET" menu (M76) only exists if your DIGIFORCE® 9311 is installed with option Vxxx3.

P 0	PROFINET	M76
SW-version	PN-V201600	
Serial number	01234567	
Control via	PROFINET	
Device MAC	00-23-6E-00-00-01	
Port1 MAC	00-23-6E-00-00-02	
Port2 MAC	00-23-6E-00-00-03	
Name of station	digiforce9311	

Diagram 29: PROFINET settings – page 1

Parameters in the "PROFINET" menu (M76)

SW-version	Firmware version of the PROFINET Fieldbus module
Serial number	Serial number of the Fieldbus module
Control via	<p>PROFINET: the DIGIFORCE® 9311 responds solely to control signals (inputs) from the PROFINET interface.</p> <p>PLC: the DIGIFORCE® 9311 responds solely to control signals (inputs) from the PLC I/O interface.</p> <p>When control via PLC I/O is selected, data is still transferred on the PROFINET real-time channel.</p>
Device MAC	Address for identifying the Fieldbus module in the PROFINET network.
Port1 MAC	Port 1 MAC address
Port2 MAC	Port 2 MAC address
Name of station	The station name assigned by the PROFINET host.
IP address	Assigned IP address Please note: this parameter cannot be changed in the DIGIFORCE® 9311.

Subnet mask	Assigned subnet mask Please note: this parameter cannot be changed in the DIGIFORCE [®] 9311.
Gateway	Assigned gateway address Please note: this parameter cannot be changed in the DIGIFORCE [®] 9311.

Note: Details of the PROFINET interface are provided in a separate document: "The DIGIFORCE[®] 9311 PROFINET manual".

DIGIFORCE[®] model 9311

6.1.18 EtherNet/IP settings (option)

Note: The "EtherNet/IP" menu (M77) only exists if your DIGIFORCE[®] 9311 is installed with option Vxxx4.

P 0	EtherNet/IP		M77
SW-version	EIP-V1601		
Serial number	01234567		
Control via	EtherNet/IP		
MAC address	00-23-6E-00-02-F9		
IP Configuration	DHCP		
IP address	169	254	044 011
Subnet mask	255	255	000 000
Gateway	000	000	000 000



Diagram 30: EtherNet/IP settings

Parameters in the "EtherNet/IP" menu (M77)

SW-version	Firmware version of the EtherNet/IP Fieldbus module
Serial number	Serial number of the Fieldbus module
Control via	<p>EtherNet/IP: the DIGIFORCE[®] 9311 responds solely to control signals (inputs) from the EtherNet/IP interface.</p> <p>PLC: the DIGIFORCE[®] 9311 responds solely to control signals (inputs) from the PLC I/O interface.</p> <p>When control via PLC I/O is selected, data is still transferred on the EtherNet/IP real-time channel.</p>
MAC address	Address for identifying the Fieldbus module in the EtherNet/IP network.
IP configuration	<p>Network configuration type (BOOTP, DHCP, static)</p> <p>Please note: this parameter cannot be changed in the DIGIFORCE[®] 9311.</p>
IP address	<p>IP address</p> <p>If BOOTP or DHCP is selected for "IP Configuration", the IP address is assigned by a BOOTP or DHCP server.</p> <p>Please note: the IP address cannot be changed by the user if BOOTP or DHCP is selected for the IP configuration mode.</p>

Subnet mask	<p>Subnet mask</p> <p>If BOOTP or DHCP is selected for "IP Configuration", the subnet mask is assigned by a BOOTP or DHCP server.</p> <p>Please note: the subnet mask cannot be changed by the user if BOOTP or DHCP is selected for the IP configuration mode.</p>
Gateway	<p>Gateway address</p> <p>If BOOTP or DHCP is selected for "IP Configuration", the gateway is assigned by a BOOTP or DHCP server.</p> <p>Please note: the gateway address cannot be changed by the user if BOOTP or DHCP is selected for the IP configuration mode.</p>

Note: Details of the EtherNet/IP interface are provided in a separate document: "The DIGIFORCE[®] 9311 EtherNet/IP manual".

6.2 Program selection

In the "Program selection" menu (M82) you can select the measurement program number and give the program a name.

Program number selection

Select the measurement program for which you wish to make specific settings.



When you enter the configuration level, the DIGIFORCE[®] 9311 always presents the currently active measurement program.

Naming the program

Specify a name for the selected measurement program. You can enter this program name in the "Enter program name" dialog box. You can enter up to 20 alphanumeric characters and/or special characters.



This is how it works









- 1 To open the "Program selection" menu from measurement mode, tap anywhere on the touchscreen. The  icon appears in the bottom-right corner.
- 2 Tap  to open the "Configuration Main Menu".
- 3 Tap the "Program Select" icon.
- 4 Enable the radio button for the program number that you wish to select.
- 5 Tap **[Program X]** for the selected program number to change the program name.
- 6 Use the keypad to enter your required program name and confirm with **[OK]**.
- 7 Tap  to return to the "Configuration Main Menu" menu.

Note: You can choose to display the  icon permanently in measurement mode. For further details, please see section 6.1.1 "Function key definition" on page 44.

6.3 Program Setup Menu



The "Program Setup Menu" (M78) contains all the settings that relate specifically to measurement programs.

You can edit or view the following settings and information in the "Program Setup Menu" (M78):

	Channel settings		Measurement mode		Evaluation
	Switching points		Graphical test operation		Numerical test operation
	Sensor test		User-defined values		USB flash



This is how it works

- 1 To open the "Program Setup Menu" from measurement mode, tap anywhere on the touchscreen. The  icon appears in the bottom-right corner.
- 2 Tap  to open the "Configuration Main Menu".
- 3 Tap the "Program Setup" icon.

Note: You can choose to display the  icon permanently in measurement mode. For further details, please see section 6.1.1 "Function key definition" on page 44.

6.3.1 Channel settings

Note: In the Basic setup menu you can define whether you want the channel settings to apply to all the measurement programs ("globally"), or specifically to each measurement program ("program depending"). Please note that when the "globally" option is set, any change will overwrite the settings for all the measurement programs. For further details, please see section 6.1.14 "Channel settings" on page 62. The factory-set default is "globally".

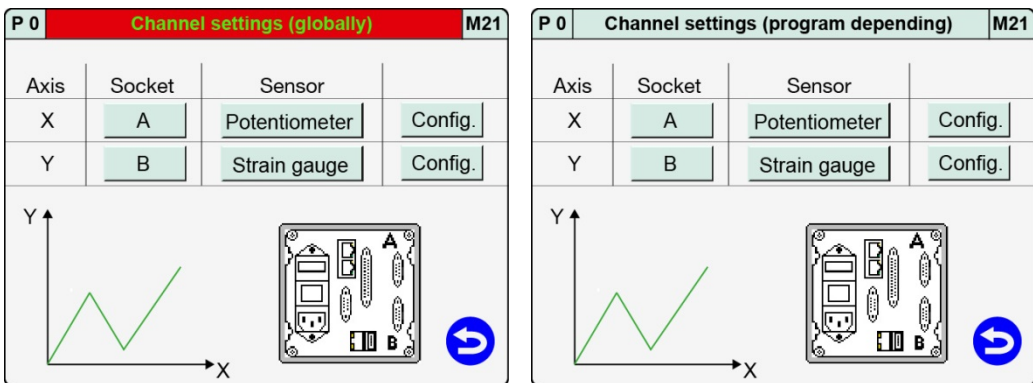

Diagram 31: "global" and "program dependent" channel settings

In the "Channel settings" menu (M21), you can assign the physical connectors (A and B) to the active X and Y measurement channels. There is no restriction on which active measurement channel (X-axis or Y-axis) you assign to which connector. You can also define a time axis instead of a connector.



This is how it works

- 1 In measurement mode, tap anywhere on the touchscreen. The icon appears in the bottom-right corner.
- 2 Tap to open the "Configuration Main Menu".
- 3 Tap the "Program Setup" icon.
- 4 Tap the "Channel Setup" icon.

IMPORTANT: Before closing the menu you must press **[ENTER]** to save any changes you have made to the settings, otherwise the settings are lost.

Parameters in the "Channel settings" menu (M21)

Axis	X, Y	Active measurement channel, X or Y. You cannot edit this parameter.
Socket	A, B, t (time)	Assign a physical connector to measurement channel X or Y. (Alternatively you can set a time axis here.)
Sensor		Assign the relevant sensor type: Connector A: potentiometer or standard signal Connector B: strain gage or standard signal (Piezoelectric as an option)
Config.		Submenu for sensor-specific channel settings

6.3.1.1 Scaling analog sensors (strain gage, potentiometer, standard signal sensors)

2-point scaling is used to associate the measured electrical signals with the measured physical quantities. In this process, you assign a lower and upper calibration value (electrical quantity) to a lower and upper scale value for the measured physical quantity. You can enter the "lower calibration" and "upper calibration" values (electrical quantities) as numerical values or you can measure them using the functions **[Teach in lower calibration]** and **[Teach in upper calibration]**.

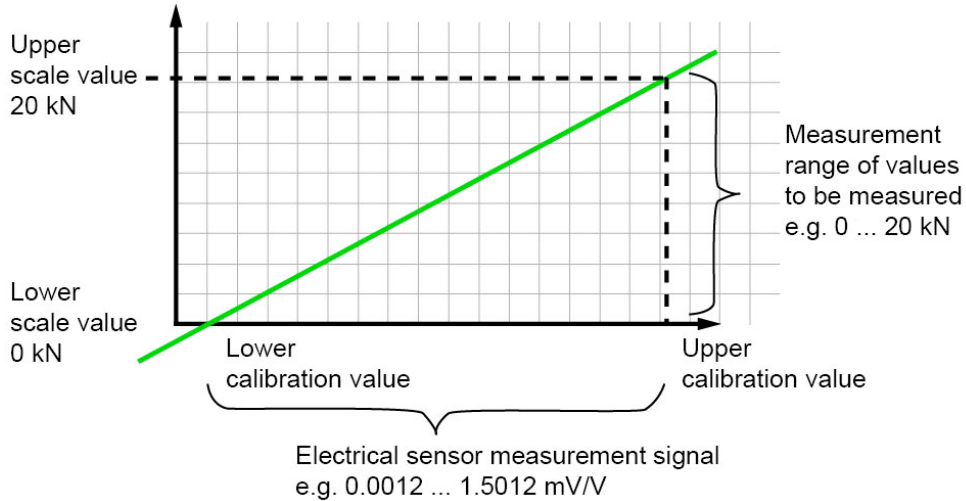

Diagram 32: Scaling analog sensors

6.3.1.2 Inverting measurement signals

You can easily invert a measurement signal using the sign definition for the scaling values given under "Lower scale" and "Upper scale".

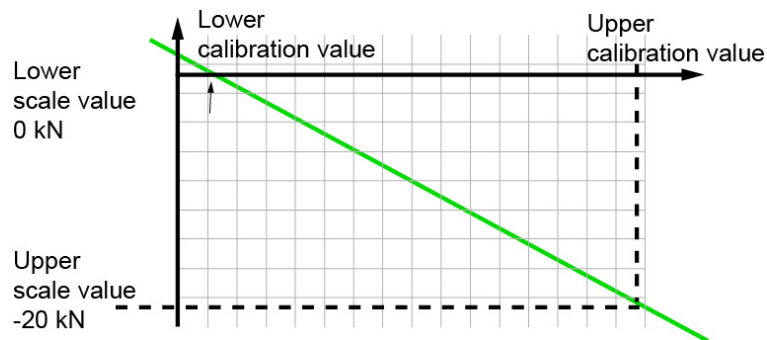

Diagram 33: Inverting measurement signals

6.3.1.3 Configuring sensors fitted with burster TEDS

If a connected sensor is equipped with burster TEDS, you can use the **[Read TEDS data]** function in the Channel settings to get the DIGIFORCE® 9311 to upload the sensor specification. The instrument can then use this specification to make the necessary channel settings automatically. Further information on this feature appears below in the subsections dealing with the particular sensors. The DIGIFORCE® 9311 does not support the TEDS function for the optional piezoelectric input.

Note: If when using burster TEDS sensors you wish to invert a signal, you can do this by changing the sign in the scaling values. You must make the change after importing the TEDS data (**[Read TEDS]**).

6.3.1.4 Potentiometric sensors

You can connect potentiometric sensors to connector A.

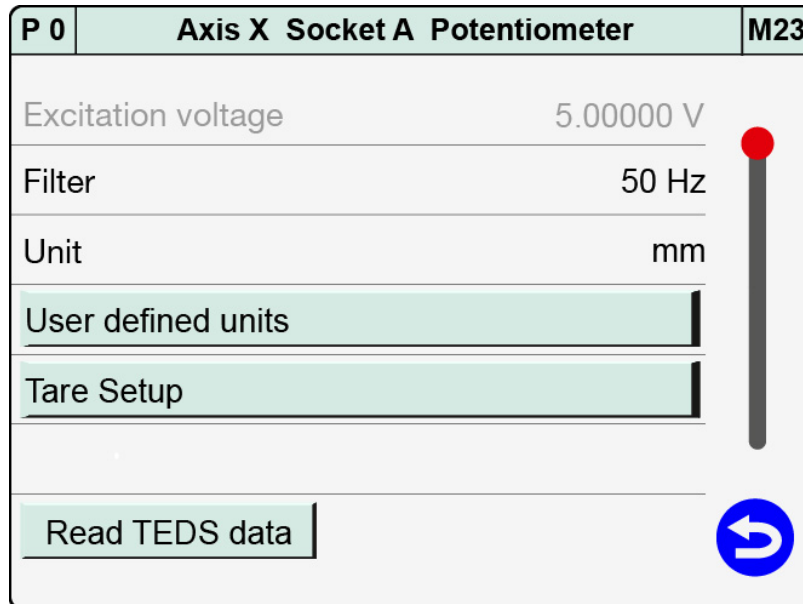

Diagram 34: Channel settings for potentiometric sensors - page 1

Parameters in the "X-axis Socket A Potentiometer" menu (M23) – page 1

Excitation voltage	5 V	Shows the excitation voltage for the potentiometer This value cannot be changed. The excitation voltage is always on.
Filter	Off, 5, 10, 25, 50, 100, 200, 400, 800 Hz	Filter setting for the measurement channel (Default value = 50 Hz)
Units	aaaa, bbbb, cccc, mm, N, kN, Nm, Ncm, deg, bar, V, s, ms	Units for the measurement channel You can select the units from a list. Alternatively, you can also specify user-defined units.

Note: For further information on **[User-defined units]** **[Tare Setup]** and **[Read TEDS data]**, please refer to the relevant subsections below.

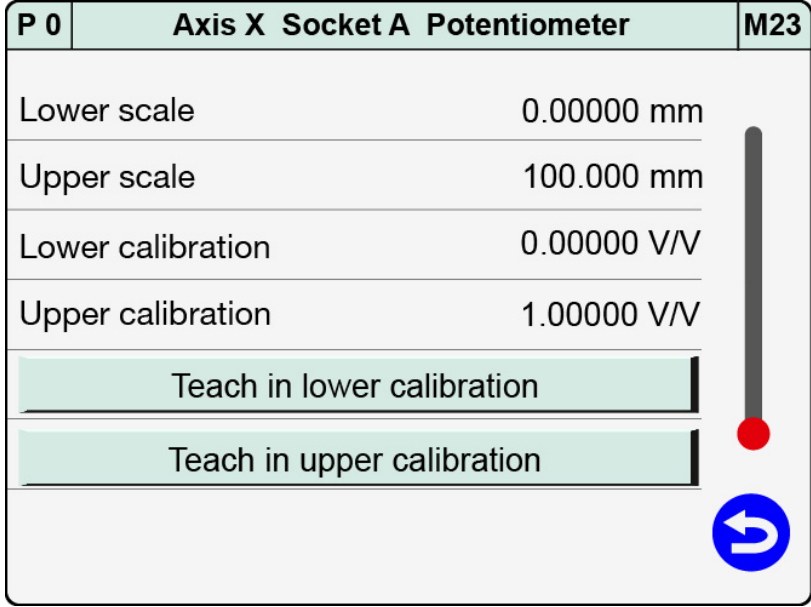

Diagram 35: Channel settings for potentiometric sensors - page 2

Parameters in the "X-axis Socket A Potentiometer" menu (M23) – page 2



Lower scale	<value input>	Enter the lower scale value for 2-point scaling (typically = 0).
Upper scale	<value input>	Enter the upper scale value for 2-point scaling (typically 100 % of the sensor measurement range).
Lower calibration	<value input> <measurement>	<p>Enter the lower calibration value for 2-point scaling or train the value using the teach-in function.</p> <p>The [Teach in lower calibration] button runs this function.</p> <p>The teach-in function only works if the sensor is connected and the correct channel parameters have been set.</p> <p>Units [V/V]</p> <p>The calibration values are normalized to an excitation voltage of 1 V. This eliminates errors caused by variations in excitation voltages, for instance if the instrument is replaced. In addition, sensors with a specific sensitivity can be configured without a teaching process.</p>
Upper calibration	<value input> <measurement>	<p>Enter the upper calibration value for 2-point scaling or teach the value using the teach-in function.</p> <p>The [Teach in upper calibration] button runs this function.</p> <p>The teach-in function only works if the sensor is connected and the correct channel parameters have been set.</p> <p>Units [V/V]</p>

Note: The mechanical travel of potentiometric displacement sensors is greater than the specified measurement travel. Therefore an electrical dead zone usually exists at each end. Within this zone, you cannot measure any change in the electrical output signal despite a movement being made.

Note: The **[Teach in lower calibration]** and **[Teach in upper calibration]** buttons can be used to measure the upper and lower calibration values. For the calibration, use a calibrated gage block that matches the full measurement range of the sensor as closely as possible. Make sure that both measurement points lie outside the specified dead zone. There must be a certain distance between the measurement points and the mechanical limits of travel of the sensor. We recommend positioning the measurement range with respect to the mechanical centre ($\pm 50\%$ about the mechanical centre).



This is how it works

- 1 In measurement mode, tap anywhere on the touchscreen. The  icon appears in the bottom-right corner.
- 2 Tap  to open the "Configuration Main Menu".
- 3 Tap the "Program Setup" icon.
- 4 Tap the "Channel Setup" icon.
- 5 You can configure each axis independently. Under "Socket", select the relevant connector for the axis concerned. Then select "Potentiometer" under "Sensor".

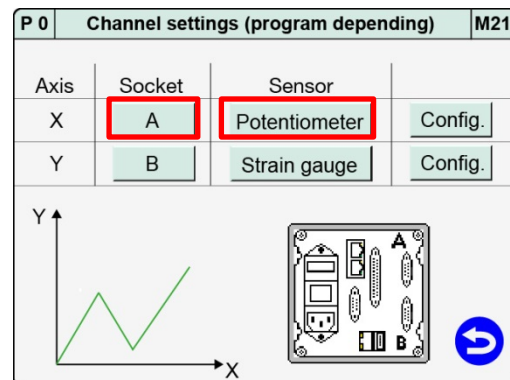

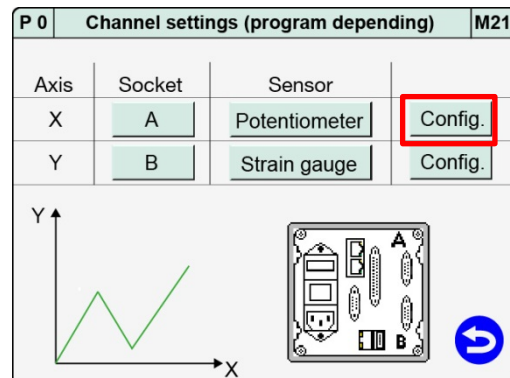

- 6 Tap **[Config.]** in the relevant row.



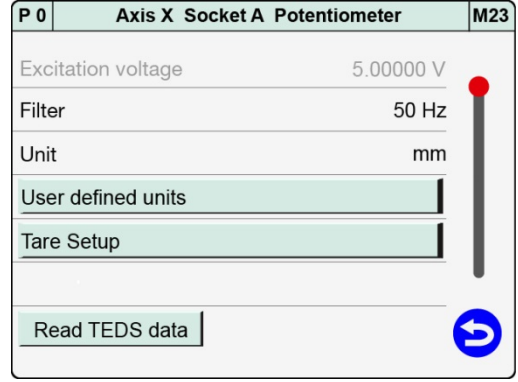

DIGIFORCE® model 9311

7 Make the sensor-specific settings for the potentiometric sensor.

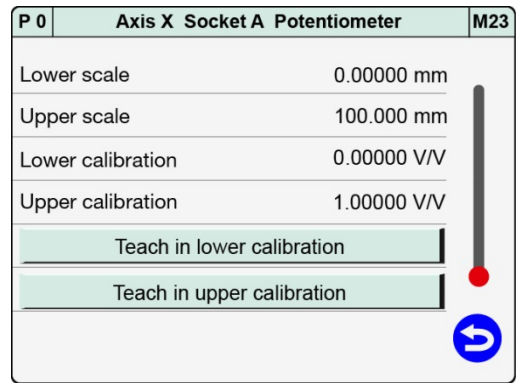

8 Swipe  the touchscreen to open the second page. Make further sensor-specific settings for the potentiometric sensor on this page.



9 Tap  to return to the "Channel settings" menu.

10 Tap  to close the "Channel settings" menu.



Note: Before closing the menu you must press **[ENTER]** to save any changes you have made to the settings, otherwise the settings are lost.

Using user-defined units

The "Unit" parameter offers you a choice of physical units. You can also define your own units as an alternative.



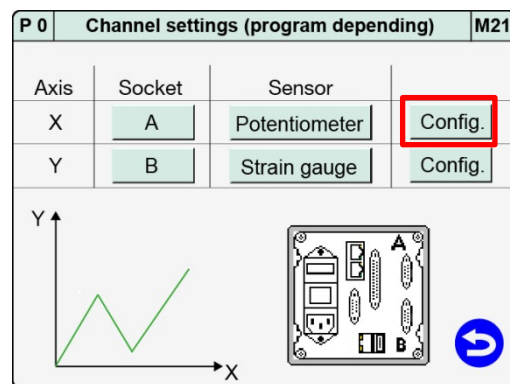

This is how it works

- 1 In measurement mode, tap anywhere on the touchscreen. The  icon appears in the bottom-right corner.
- 2 Tap  to open the "Configuration Main Menu".
- 3 Tap the "Program Setup" icon.
- 4 Tap the "Channel Setup" icon.
- 5 Tap **[Config.]** in the "X" row.

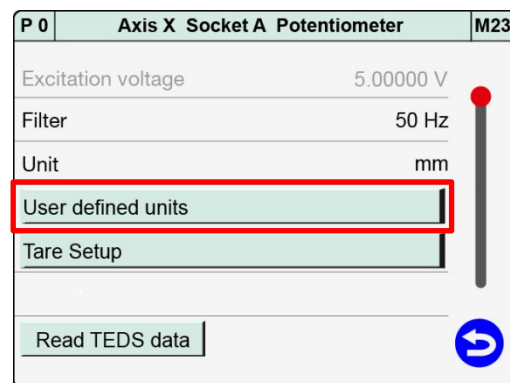

- 6 Tap **[User defined units]**.





- 7 Tap the row in which you want to customize the units and then enter the value via the keypad. The units that you have specified are now displayed under "Unit" in the selection menu.
- 8 Tap  to return to the menu "X-axis Socket A Potentiometer".

DIGIFORCE® model 9311

Tare setup for potentiometric sensors

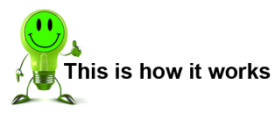
In the menu "X-axis Potentiometer Taring" (M62) you can make additional tare settings for this channel.



- 1 In measurement mode, tap anywhere on the touchscreen. The  icon appears in the bottom-right corner.
- 2 Tap  to open the "Configuration Main Menu".
- 3 Tap the "Program Setup" icon.
- 4 Tap the "Channel Setup" icon.
- 5 Tap **[Config.]** in the "X" row.

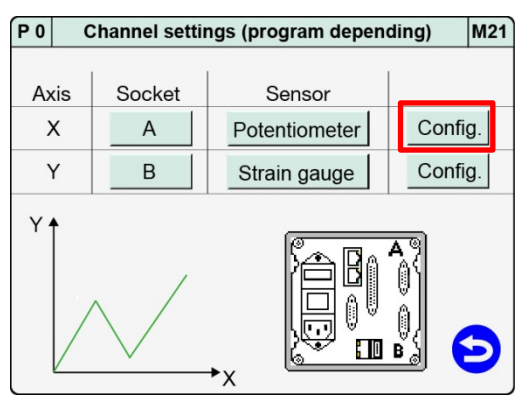

- 6 Tap **[Tare Setup]**.

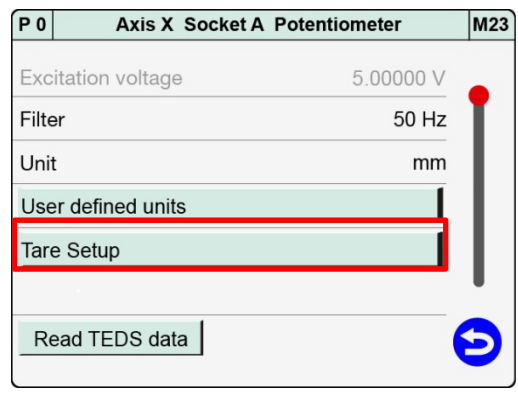

- 7 Enable the checkbox "Tare at meas. start" and use the keypad to enter the default tare value ("Standard value for tare"). If you enable the "OUT_WARNING_TARE" checkbox, then the "OUT_WARNING_TARE" control output will be set if the Tare warning limit is exceeded.

P 0	Axis X Potentiometer Taring	M62
	Tare at meas. start	<input type="checkbox"/>
	Standard value for tare	0.00000 mm
	OUT_WARNING_TARE	<input type="checkbox"/>
	Tare warning limit	----
		

- 8 Tap  to return to the menu "X-axis Socket A Potentiometer".

Parameters in the "X-axis Potentiometer Taring" menu (M62)

Tare at meas. start	On / Off	Enable/disable Enabled: At every start of a measurement, the channel is automatically tared to the default tare value ("Standard value for tare").
Standard value for tare	<value input>	A typical tare value is 0.0.
OUT_WARNING_TARE	On / Off	Enable/disable Enabled: If the signal to be tared exceeds the "Tare warning limit", the "OUT_WARNING_TARE" control output is set. Note: This may also indicate that the sensor is faulty.
Tare warning limit	--- / 1 to 20 %	The "Tare warning limit" can be set between 1 % and 20 % with respect to the actual measurement range of the input channel (regardless of the current scaling). Note: Please note when using sensors with a high zero point offset, the function "Tare warning limit" can only be used in a limited extent or not at all.



DIGIFORCE[®] model 9311

Reading potentiometric sensors programmed with TEDS

If a connected sensor is programmed with TEDS, you can use the **[Read TEDS data]** function to get the DIGIFORCE[®] 9311 to upload the sensor specification. The instrument can then use this specification to make the necessary channel settings automatically.



This is how it works

- 1 In measurement mode, tap anywhere on the touchscreen. The  icon appears in the bottom-right corner.
- 2 Tap  to open the "Configuration Main Menu".
- 3 Tap the "Program Setup" icon.
- 4 Tap the "Channel Setup" icon.
- 5 Tap **[Config.]** in the "X" row.

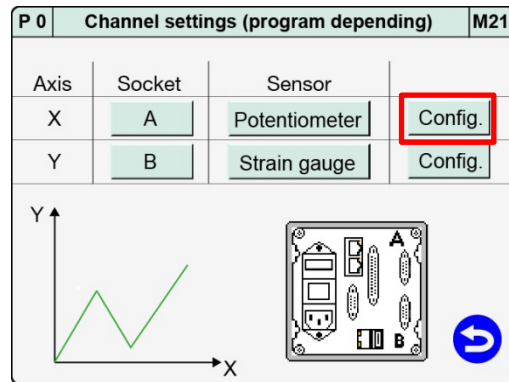

- 6 Tap **[Read TEDS data]**.

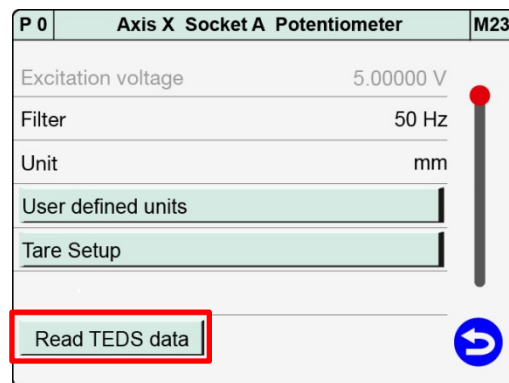

- 7 If the instrument detects a potentiometric sensor programmed with TEDS, it displays the **[TEDS Info]** button.

Note: Once it has read the TEDS data, the instrument overwrites the relevant parameters such as the scaling and calibration values. These parameters can be post-edited, for instance to set signal inversion.

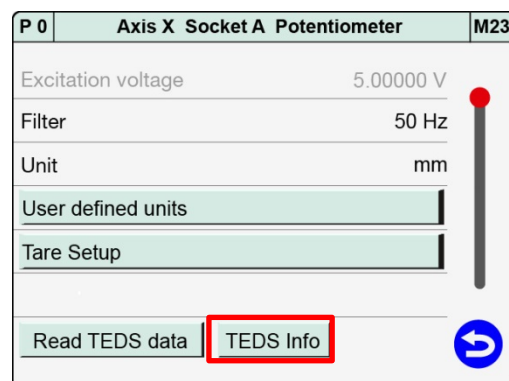

- 8 Tap **[TEDS Info]** to display the data from the potentiometric sensor. Tap **[ENTER]** to close the display.

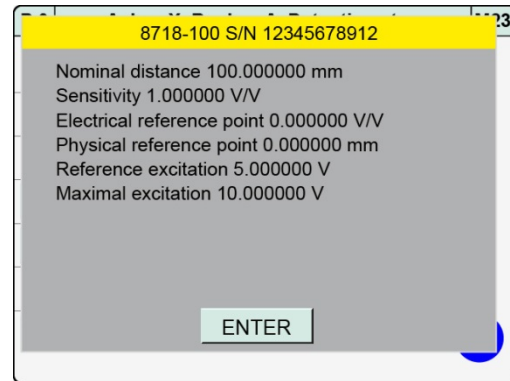

- 9 If the instrument has not detected a potentiometric sensor programmed with TEDS, it displays a window containing the message "No TEDS found".

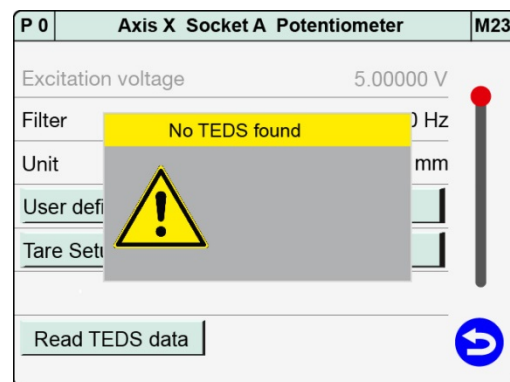

DIGIFORCE® model 9311

6.3.1.5 Sensors that output a standard signal

You can connect standard-signal sensors to connectors A and B.

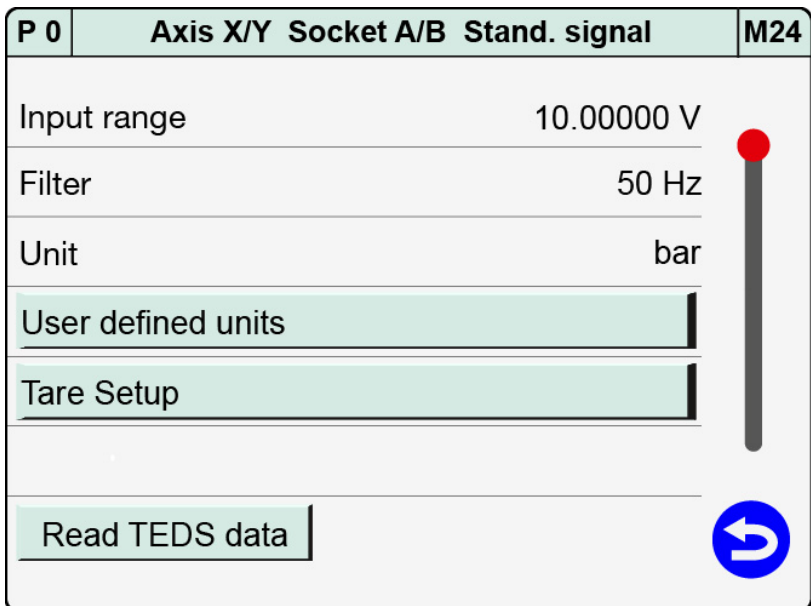

Diagram 36: Channel settings for standard-signal sensors - page 1

Note: Please note that the DIGIFORCE® 9311 does not provide a supply voltage for active sensors.

Parameters in the "X/Y-axis Socket A/B Standard signal" menu (M24) – page 1

Input range	5 V / 10 V	Input range selection: 5 V or 10 V
Filter	Off, 5, 10, 25, 50, 100, 200, 400, 800 Hz	Filter setting for the measurement channel (Default value = 50 Hz) If set to Off: 5 kHz RC filter
Units	aaaa, bbbb, cccc, mm, N, kN, Nm, Ncm, deg, bar, V, s, ms	Units for the measurement channel You can select the units from a list. Alternatively, you can also specify user-defined units.

Note: For further information on [User-defined units] [Tare Setup] and [Read TEDS data], please refer to the relevant subsections below.

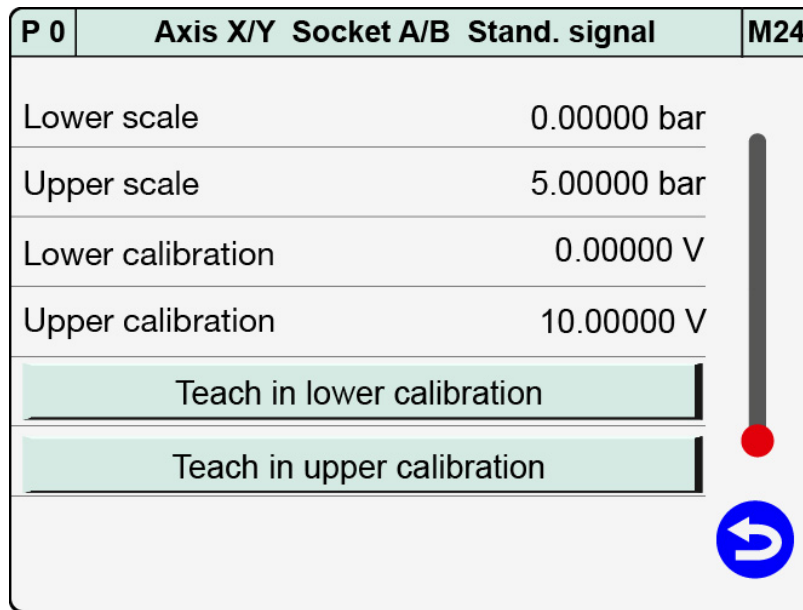

Diagram 37: Channel settings for standard-signal sensors - page 2



Parameters in the "X/Y-axis Socket A/B Standard signal" menu (M24) – page 2

Lower scale	<value input>	Enter the lower scale value for 2-point scaling (typically = 0).
Upper scale	<value input>	Enter the upper scale value for 2-point scaling (typically 100 % of the sensor measurement range).
Lower calibration	<value input> <measurement>	Enter the lower calibration value for 2-point scaling or train the value using the teach-in function. The [Teach in lower calibration] button runs this function. The teach-in function only works if the sensor is connected and the correct channel parameters have been set.
Upper calibration	<value input> <measurement>	Enter the upper calibration value for 2-point scaling or train the value using the teach-in function. The [Teach in upper calibration] button runs this function. The teach-in function only works if the sensor is connected and the correct channel parameters have been set.

DIGIFORCE[®] model 9311



This is how it works

- 1 In measurement mode, tap anywhere on the touchscreen. The  icon appears in the bottom-right corner.
- 2 Tap  to open the "Configuration Main Menu".
- 3 Tap the "Program Setup" icon.
- 4 Tap the "Channel Setup" icon.
- 5 You can configure each axis independently. Under "Socket", select the relevant connector for the axis concerned. Then select "Stand. signal" under "Sensor".

P 0	Channel settings (program depending)		M21
Axis	Socket	Sensor	
X	A	Stand. signal	Config.
Y	B	Strain gauge	Config.

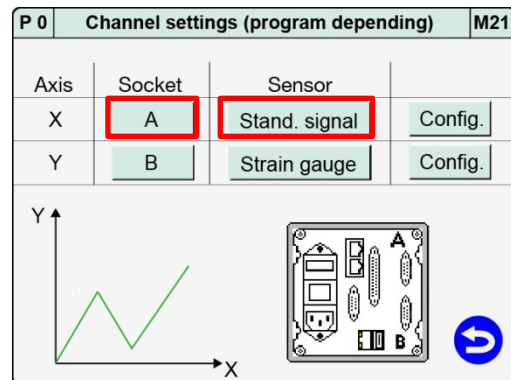

- 6 Tap **[Config.]** in row "X" or row "Y" (depending on which socket you have used to connect the standard-signal sensor).

P 0	Channel settings (program depending)		M21
Axis	Socket	Sensor	
X	A	Stand. signal	Config.
Y	B	Strain gauge	Config.

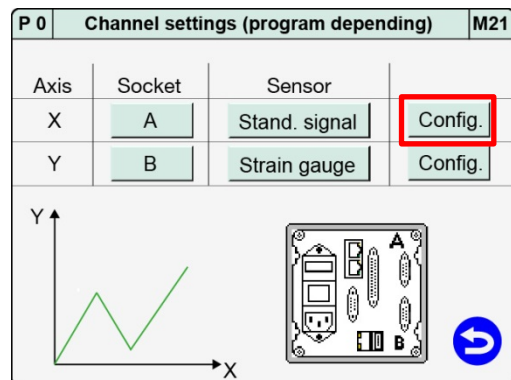



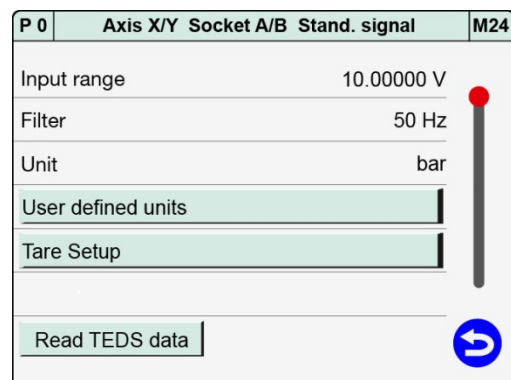

- 7 Make the sensor-specific settings for the standard-signal sensor.

P 0	Axis X/Y	Socket A/B	Stand. signal	M24
Input range			10.00000 V	
Filter			50 Hz	
Unit			bar	
User defined units				
Tare Setup				
Read TEDS data				



- 8 Swipe  the touchscreen to open the second page. Make further sensor-specific settings for the standard-signal sensor on this page.

P 0	Axis X/Y	Socket A/B	Stand. signal	M24
	Lower scale		0.00000 bar	
	Upper scale		5.00000 bar	
	Lower calibration		0.00000 V	
	Upper calibration		10.00000 V	
	Teach in lower calibration			
	Teach in upper calibration			
				

- 9 Tap  to return to the "Channel settings" menu.
- 10 Tap  to close the "Channel settings" menu.
- Note:** Before closing the menu you must press **[ENTER]** to save any changes you have made to the settings, otherwise the settings are lost.



DIGIFORCE® model 9311

Using user-defined units

The "Unit" parameter offers you a choice of physical units. You can also define your own units as an alternative.



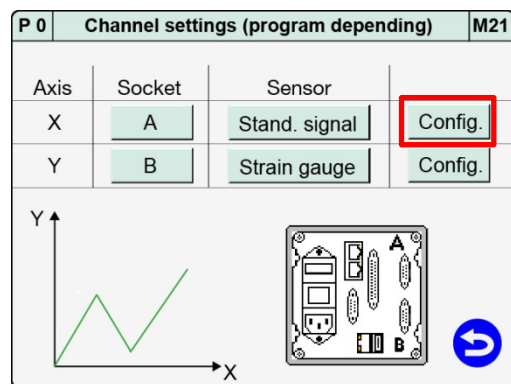

This is how it works

- 1 In measurement mode, tap anywhere on the touchscreen. The  icon appears in the bottom-right corner.
- 2 Tap  to open the "Configuration Main Menu".
- 3 Tap the "Program Setup" icon.
- 4 Tap the "Channel Setup" icon.
- 5 Tap **[Config.]** in row "X" or row "Y" (depending on which socket you have used to connect the standard-signal sensor).

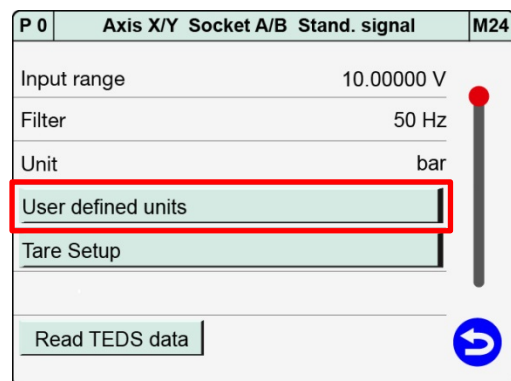

- 6 Tap **[User defined units]**.





- 7 Tap the row in which you want to customize the units and then enter the value via the keypad. The units that you have specified are now displayed under "Unit" in the selection menu.
- 8 Tap  to return to the menu "X/Y-axis Socket A Stand. signal".

Tare Setup for standard-signal sensors

In the menu "X/Y-axis Stand. signal Taring" (M62) you can make additional tare settings for this channel.



This is how it works

- 1 In measurement mode, tap anywhere on the touchscreen. The  icon appears in the bottom-right corner.
- 2 Tap  to open the "Configuration Main Menu".
- 3 Tap the "Program Setup" icon.
- 4 Tap the "Channel Setup" icon.
- 5 Tap [**Config.**] in row "X" or row "Y" (depending on which socket you have used to connect the standard-signal sensor).

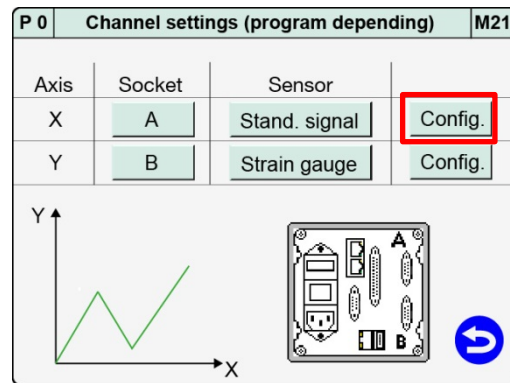

- 6 Tap [**Tare Setup**].

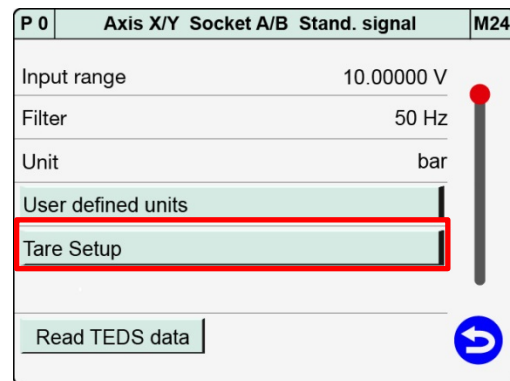

DIGIFORGE® model 9311

- 7 Enable the checkbox "Tare at meas. start" and use the keypad to enter the default tare value ("Standard value for tare"). If you enable the "OUT_WARNING_TARE" checkbox, then the "OUT_WARNING_TARE" control output will be set if the Tare warning limit is exceeded.

P 0	Axis X/Y	Stand. signal	Taring	M62
			Tare at meas. start	<input type="checkbox"/>
			Standard value for tare	0.00000 bar
			OUT_WARNING_TARE	<input type="checkbox"/>
			Tare warning limit	----



- 8 Tap  to return to the menu "X/Y-axis Socket A Stand. signal".

Parameters in the "X/Y-axis Stand. signal Taring" menu (M62)



Tare at meas. start	On / Off	Enable/disable Enabled: At every start of a measurement, the channel is automatically tared to the default tare value ("Standard value for tare").
Standard value for tare	<value input>	A typical tare value is 0.0.
OUT_WARNING_TARE	On / Off	Enable/disable Enabled: If the signal to be tared exceeds the "Tare warning limit", the "OUT_WARNING_TARE" control output is set. Note: This may also indicate that the sensor is faulty.
Tare warning limit	--- / 1 to 20 %	The "Tare warning limit" can be set between 1 % and 20 % with respect to the actual measurement range of the input channel (regardless of the current scaling). Note: Please note when using sensors with a high zero point offset, the function "Tare warning limit" can only be used in a limited extent or not at all.

Reading standard-signal sensors programmed with TEDS

If a connected sensor is programmed with TEDS, you can use the **[Read TEDS data]** function to get the DIGIFORCE® 9311 to upload the sensor specification. The instrument can then use this specification to make the necessary channel settings automatically.



This is how it works

- 1 In measurement mode, tap anywhere on the touchscreen. The  icon appears in the bottom-right corner.
- 2 Tap  to open the "Configuration Main Menu".
- 3 Tap the "Program Setup" icon.
- 4 Tap the "Channel Setup" icon.
- 5 Tap **[Config.]** in row "X" or row "Y" (depending on which socket you have used to connect the standard-signal sensor).

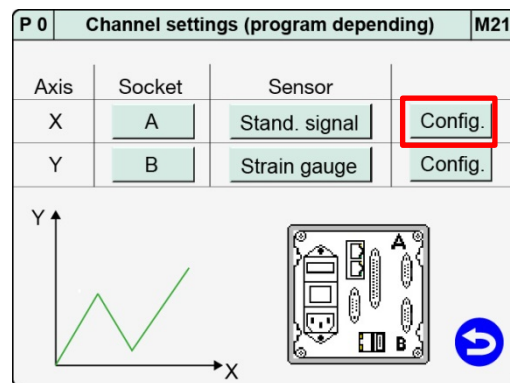

- 6 Tap **[Read TEDS data]**.

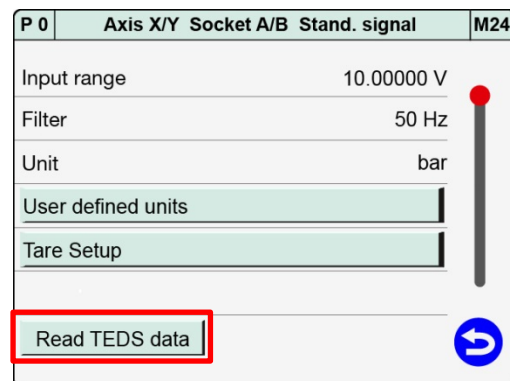

- 7 If the instrument detects a standard-signal sensor programmed with TEDS, it displays the **[TEDS Info]** button.

Note: Once it has read the TEDS data, the instrument overwrites the relevant parameters such as the scaling and calibration values. These parameters can be post-edited, for instance to set signal inversion.

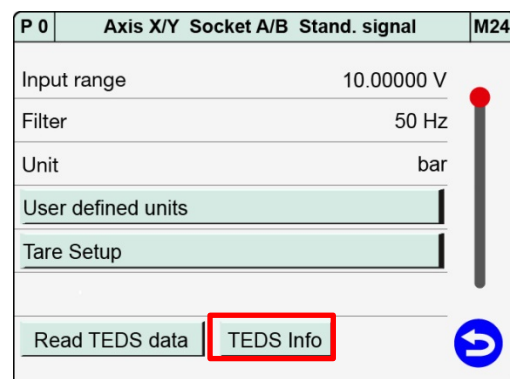

DIGIFORCE® model 9311

- 8 Tap **[TEDS Info]** to display the data from the standard-signal sensor. Tap **[ENTER]** to close the display.

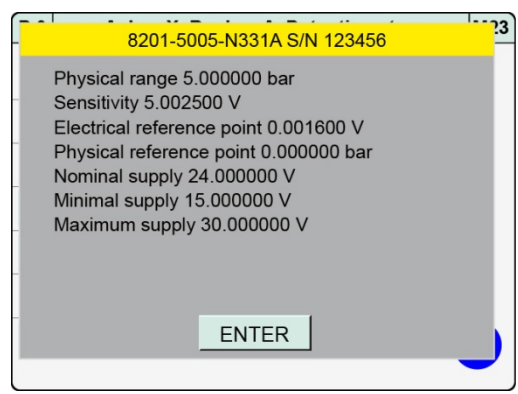

- 9 If the instrument has not detected a standard-signal sensor programmed with TEDS, it displays a window containing the message "No TEDS found".

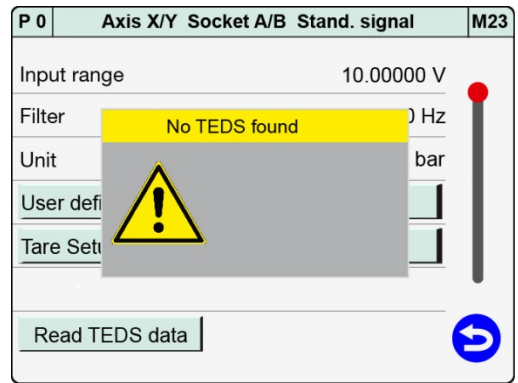

6.3.1.6 Strain gage sensors

You can connect strain gage sensors to connector B.

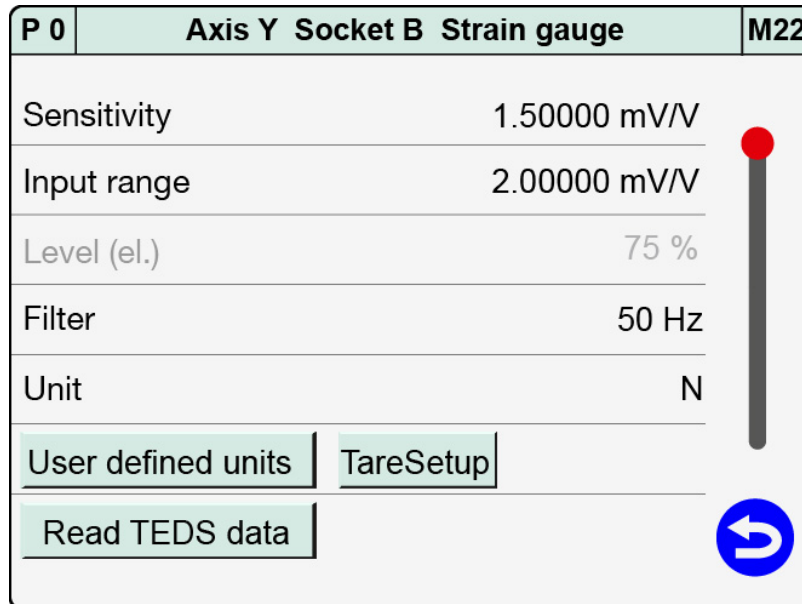

Diagram 38: Channel settings for strain gage sensors - page 1

Note: A 5 VDC excitation voltage is used for strain gages.

Parameters in the "Y-axis Socket B Strain gage" menu (M22) – page 1

Sensitivity	0.02 to 100 mV/V	Enter the strain gage sensitivity This value is used solely for calculating and displaying the electrical output level. This parameter has no relevance to the internal channel settings.
Input range	2, 4, 10, 20, 40 mV/V	Input range selection for the strain gage In order to be able to use 100 % of the measurement range of the connected sensor, the selected input range must be \geq the sensor sensitivity.
Level (el.)	Value in %	Shows the electrical output level from the measurement channel
Filter	Off, 5, 10, 25, 50, 100, 200, 400, 800 Hz	Filter setting for the measurement channel (Default value = 50 Hz)
Units	aaaa, bbbb, cccc, mm, N, kN, Nm, Ncm, deg, bar, V, s, ms	Units for the measurement channel You can select the units from a list. Alternatively, you can also specify user-defined units.

Note: For further information on [User-defined units] [Tare Setup] and [Read TEDS data], please refer to the relevant subsections below.

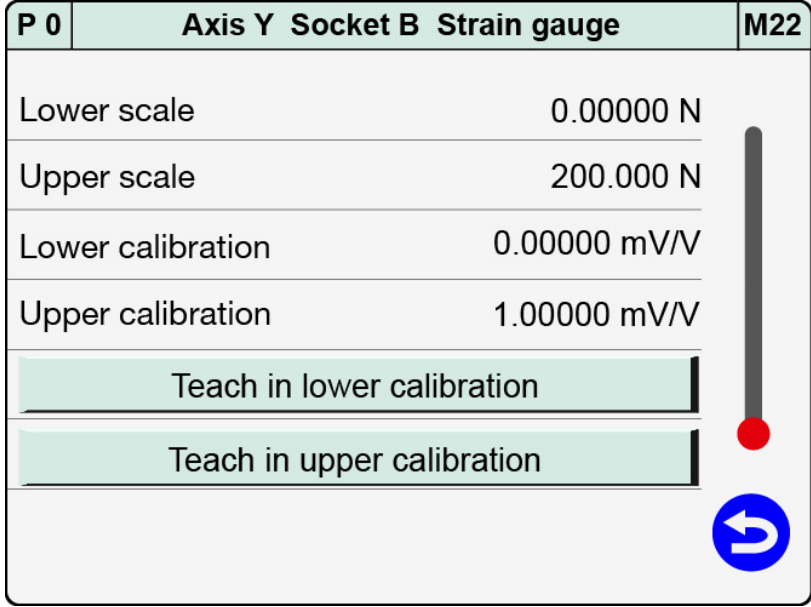



Diagram 39: Channel settings for strain gage sensors - page 2

Parameters in the "Y-axis Socket B Strain gage" menu (M22) – page 2



Lower scale	<value input>	Enter the lower scale value for 2-point scaling (typically = 0).
Upper scale	<value input>	Enter the upper scale value for 2-point scaling (typically 100 % of the sensor measurement range).
Lower calibration	<value input> <measurement>	Enter the lower calibration value for 2-point scaling or train the value using the teach-in function. The [Teach in lower calibration] button runs this function. The teach-in function only works if the sensor is connected and the correct channel parameters have been set.
Upper calibration	<value input> <measurement>	Enter the upper calibration value for 2-point scaling or train the value using the teach-in function. The [Teach in upper calibration] button runs this function. The teach-in function only works if the sensor is connected and the correct channel parameters have been set.



This is how it works

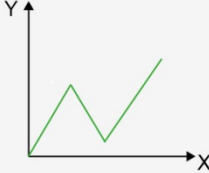

- 1 In measurement mode, tap anywhere on the touchscreen. The  icon appears in the bottom-right corner.
- 2 Tap  to open the "Configuration Main Menu".
- 3 Tap the "Program Setup" icon.
- 4 Tap the "Channel Setup" icon.
- 5 You can configure each axis independently. Under "Socket", select the relevant connector for the axis concerned. Then select "Strain gage" under "Sensor".

P 0	Channel settings (program depending)			M21
Axis	Socket	Sensor		
X	A	Potentiometer		Config.
Y	B	Strain gauge		Config.





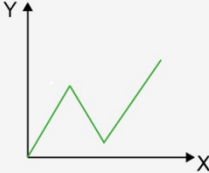

- 6 Tap [Config.] in the relevant row.

P 0	Channel settings (program depending)			M21
Axis	Socket	Sensor		
X	A	Potentiometer		Config.
Y	B	Strain gauge		Config.







- 7 Make the sensor-specific settings for the strain gage sensor.
Note: A 5 VDC excitation voltage is used for strain gages.

P 0	Axis Y Socket B Strain gauge		M22
Sensitivity	1.50000 mV/V		
Input range	2.00000 mV/V		
Level (el.)	75 %		
Filter	50 Hz		
Unit	N		
User defined units		TareSetup	
Read TEDS data			





DIGIFORCE® model 9311

- 8 Swipe  the touchscreen to open the second page. Make further sensor-specific settings for the strain gage sensor on this page.

P 0	Axis Y Socket B Strain gauge	M22
Lower scale	0.00000 N	
Upper scale	200.000 N	
Lower calibration	0.00000 mV/V	
Upper calibration	1.00000 mV/V	
Teach in lower calibration		
Teach in upper calibration		





- 9 Tap  to return to the "Channel settings" menu.
- 10 Tap  to close the "Channel settings" menu.
Note: Before closing the menu you must press **[ENTER]** to save any changes you have made to the settings, otherwise the settings are lost.

Using user-defined units

The "Unit" parameter offers you a choice of physical units. You can also define your own units as an alternative.



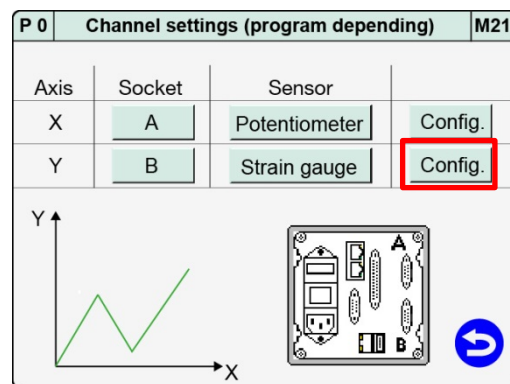

This is how it works

- 1 In measurement mode, tap anywhere on the touchscreen. The  icon appears in the bottom-right corner.
- 2 Tap  to open the "Configuration Main Menu".
- 3 Tap the "Program Setup" icon.
- 4 Tap the "Channel Setup" icon.
- 5 Tap **[Config.]** in the "Y" row.

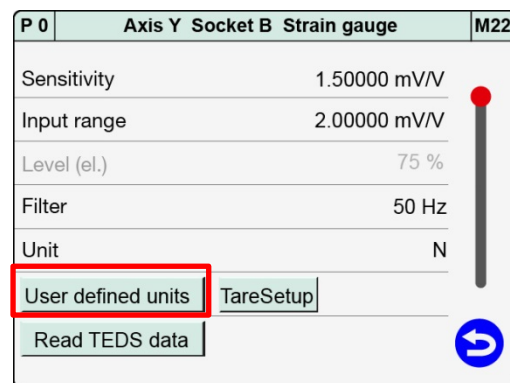

- 6 Tap **[User defined units]**.





- 7 Tap the row in which you want to customize the units and then enter the value via the keypad. The units that you have specified are now displayed under "Unit" in the selection menu.
- 8 Tap  to return to the menu "Y-axis Socket A Strain gage".

DIGIFORCE® model 9311

Tare setup for strain gage sensors

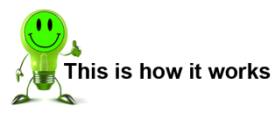
In the menu "Y-axis Strain gage Taring" (M62) you can make the extra tare settings for this channel.



- 1 In measurement mode, tap anywhere on the touchscreen. The  icon appears in the bottom-right corner.
- 2 Tap  to open the "Configuration Main Menu".
- 3 Tap the "Program Setup" icon.
- 4 Tap the "Channel Setup" icon.
- 5 Tap **[Config.]** in the "Y" row.

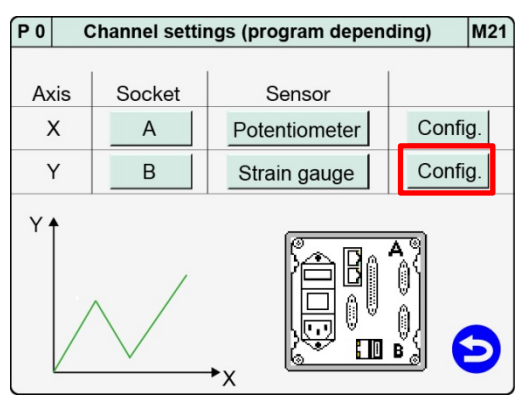

- 6 Tap **[TareSetup]**.

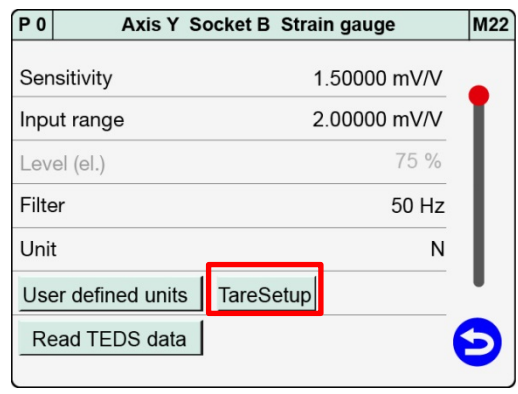

- 7 Enable the checkbox "Tare at meas. start" and use the keypad to enter the default tare value ("Standard value for tare"). If you enable the "OUT_WARNING_TARE" checkbox, then the "OUT_WARNING_TARE" control output will be set if the Tare warning limit is exceeded.

P 0	Axis Y Strain gauge Taring	M62
	Tare at meas. start	<input type="checkbox"/>
	Standard value for tare	0.00000 N
	OUT_WARNING_TARE	<input type="checkbox"/>
	Tare warning limit	----
		

- 8 Tap  to return to the menu "Y-axis Socket A Strain gage".

Parameters in the "Y-axis Strain gage Taring" menu (M62)

Tare at meas. start	On / Off	Enable/disable Enabled: At every start of a measurement, the channel is automatically tared to the default tare value ("Standard value for tare").
Standard value for tare	<value input>	A typical tare value is 0.0.
OUT_WARNING_TARE	On / Off	Enable/disable Enabled: If the signal to be tared exceeds the "Tare warning limit", the "OUT_WARNING_TARE" control output is set. Note: This may also indicate that the sensor is faulty.
Tare warning limit	--- / 1 to 20 %	The "Tare warning limit" can be set between 1 % and 20 % with respect to the actual measurement range of the input channel (regardless of the current scaling). Note: Please note when using semiconductor strain gage sensors with a high zero point offset, the function "Tare warning limit" can only be used in a limited extent or not at all.



DIGIFORCE® model 9311

Reading strain gage sensors programmed with TEDS

If a connected sensor is programmed with TEDS, you can use the **[Read TEDS data]** function to get the DIGIFORCE® 9311 to upload the sensor specification. The instrument can then use this specification to make the necessary channel settings automatically.



This is how it works

- 1 In measurement mode, tap anywhere on the touchscreen. The  icon appears in the bottom-right corner.
- 2 Tap  to open the "Configuration Main Menu".
- 3 Tap the "Program Setup" icon.
- 4 Tap the "Channel Setup" icon.
- 5 Tap **[Config.]** in the "Y" row.

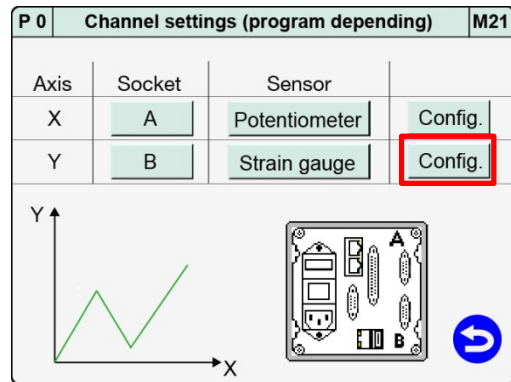

- 6 Tap **[Read TEDS data]**.

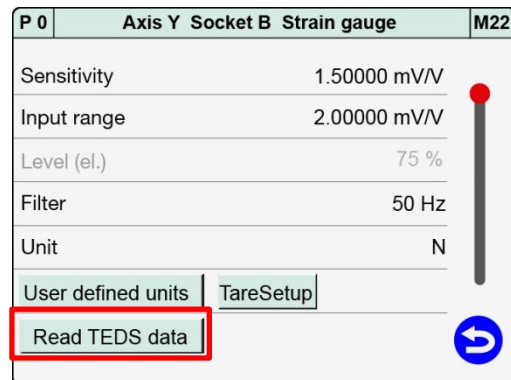

- 7 If the instrument detects a strain gage sensor programmed with TEDS, it displays the **[TEDS Info]** button.

Note: Once it has read the TEDS data, the instrument overwrites the relevant parameters such as the scaling and calibration values. These parameters can be post-edited, for instance to set signal inversion.

Note: If the permitted excitation voltage for the strain gage sensor (entry in the TEDS data) is less than the excitation voltage provided by the DIGIFORGE[®] 9311, the TEDS data is not uploaded.

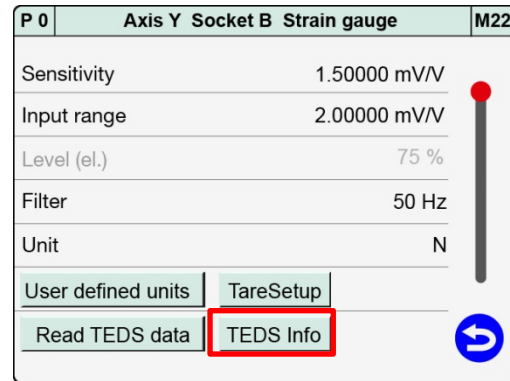

- 8 Tap **[TEDS Info]** to display the data from the strain gage sensor. Tap **[ENTER]** to close the display.

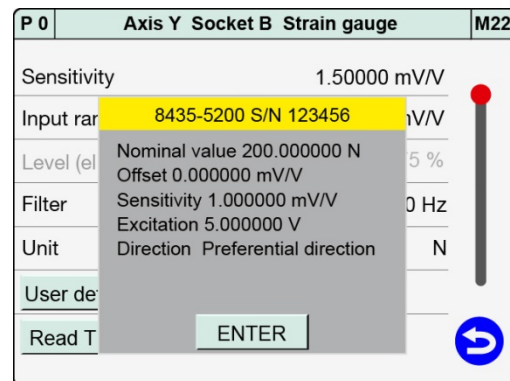

- 9 If the instrument has not detected a strain gage sensor programmed with TEDS, it displays a window containing the message "No TEDS found".

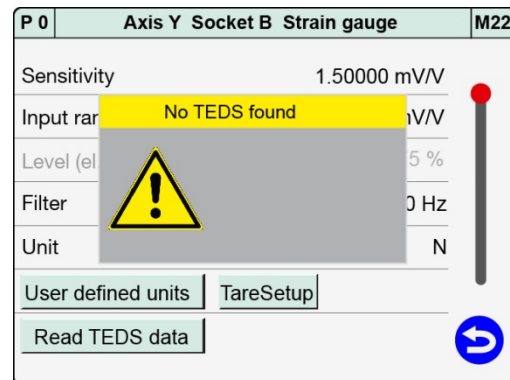

DIGIFORCE[®] model 9311

6.3.1.7 Piezoelectric sensors (option)

You can connect piezoelectric sensors (with a charge output) only to the optional piezoelectric input (connector B).

Note: For this function your DIGIFORCE[®] 9311 must be fitted with the optional piezoelectric input. With this option, connector B for a strain-gage or standard-signal input is no longer provided. The DIGIFORCE[®] 9311 does not support the TEDS function for the optional piezoelectric input.

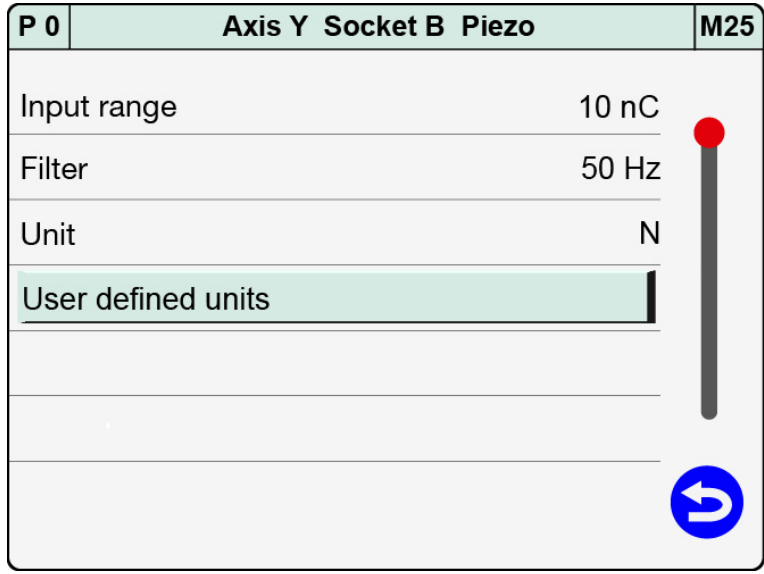

Diagram 40: Channel settings for piezoelectric sensors - page 1

Parameters in the "Y-axis Socket B Piezo" menu (M25) – page 1

Input range	1, 2, 5, 10, 20, 40, 80, 200, 400 nC, 1 μ C	Input range selection for the piezoelectric sensor You can calculate the required input range by multiplying the sensor sensitivity (e.g. 4.3 pC/N) by the measurement range. Then choose the appropriate input range; if the exact level is not available, select the next higher level.
Filter	Off, 5, 10, 25, 50, 100, 200, 400, 800 Hz	Filter setting for the measurement channel (Default value = 50 Hz)
Units	aaaa, bbbb, cccc, mm, N, kN, Nm, Ncm, deg, bar, V, s, ms	Units for the measurement channel You can select the units from a list. Alternatively, you can also specify user-defined units.

Note: For further information on [User-defined units], please refer to the relevant subsection below.

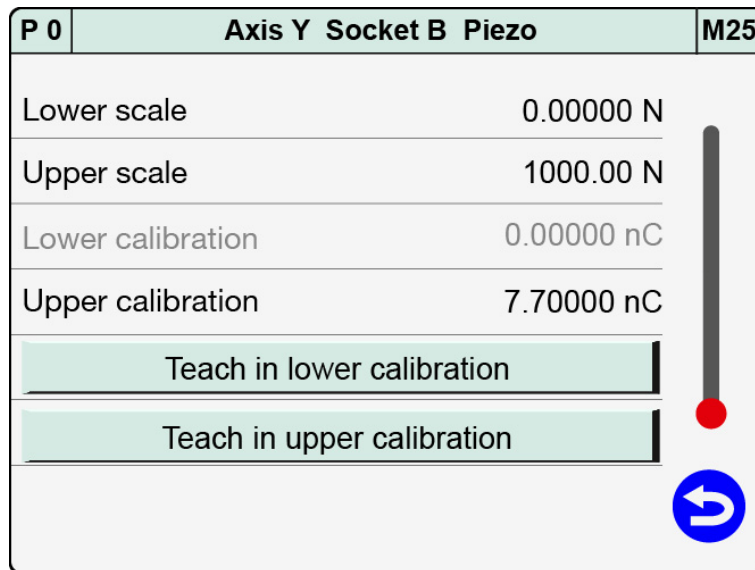

Diagram 41: Channel settings for piezoelectric sensors - page 2

Parameters in the "Y-axis Socket B Piezo" menu (M25) – page 2



Lower scale	<value input>	Enter the lower scale value for 2-point scaling (typically = 0).
Upper scale	<value input>	Enter the upper scale value for 2-point scaling (typically this is 100% of the sensor measurement range, or can be set as a multiple of 1, because the sensitivity of piezoelectric sensors is always specified as charge/mechanical units e.g. pC/N).
Lower calibration	<measurement>	<p>Measurement of the lower calibration value for 2-point scaling.</p> <p>The [Teach in lower calibration] button runs this function.</p> <p>The teach-in function only works if the sensor is connected and the correct channel parameters have been set.</p> <p>It is not possible to input a numerical value for piezoelectric sensors.</p>
Upper calibration	<value input> <measurement>	<p>Enter the upper calibration value for 2-point scaling or teach the value using the teach-in function.</p> <p>The [Teach in upper calibration] button runs this function.</p> <p>The teach-in function only works if the sensor is connected and the correct channel parameters have been set.</p>

Note: Please note that if you are basing the upper calibration value on the specified sensor sensitivity (value from the sensor test certificate) then you need to add on the trained lower calibration value when you enter the value. The difference between the upper and lower calibration values must equal the sensitivity of the sensor or the selected multiple of the current scaling.

DIGIFORCE® model 9311



This is how it works

- 1 In measurement mode, tap anywhere on the touchscreen. The  icon appears in the bottom-right corner.
- 2 Tap  to open the "Configuration Main Menu".
- 3 Tap the "Program Setup" icon.
- 4 Tap the "Channel Setup" icon.
- 5 You can configure each axis independently. Under "Socket", select the relevant connector for the axis concerned. Then select "Piezo" under "Sensor".

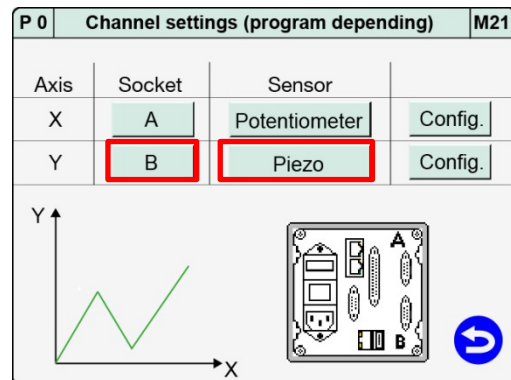

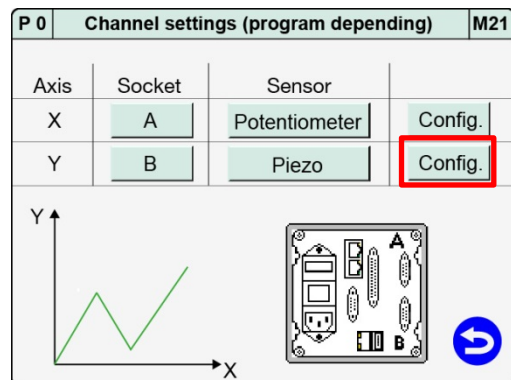

- 6 Tap **[Config.]** in the relevant row.



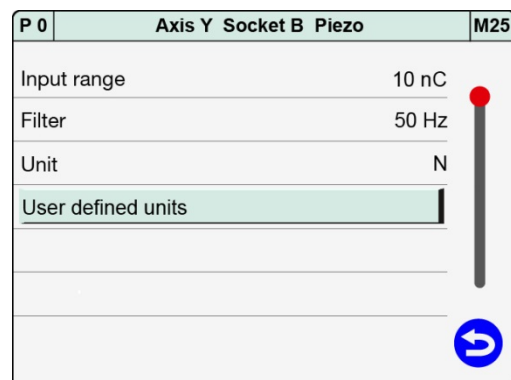

- 7 Make the sensor-specific settings for the piezoelectric sensor.



- 8 Swipe  the touchscreen to open the second page. Make further sensor-specific settings for the piezoelectric sensor on this page.

P 0	Axis Y Socket B Piezo	M25
Lower scale	0.00000 N	
Upper scale	1000.00 N	
Lower calibration	0.00000 nC	
Upper calibration	7.70000 nC	
Teach in lower calibration		
Teach in upper calibration		

- 9 Tap  to return to the "Channel settings" menu.
- 10 Tap  to close the "Channel settings" menu.
- Note:** Before closing the menu you must press **[ENTER]** to save any changes you have made to the settings, otherwise the settings are lost.

Note: The charge input for piezoelectric sensors (connector B) is always short-circuited when a measurement is not in progress. The DIGIFORCE[®] 9311 does not activate the charge amplifier until the measurement starts. This means that the DIGIFORCE[®] 9311 can then measure a change in charge (change of measurand). The DIGIFORCE[®] 9311 does this by measuring a change of measurand relative to the start of the measurement. For force transducers, the sensitivity of piezoelectric sensors (crystals) is specified in pC/N (e.g. 3.9 pC/N). To select the correct input range you must multiply the measurement range by this sensitivity.



DIGIFORCE® model 9311

Using user-defined units

The "Unit" parameter offers you a choice of physical units. You can also define your own units as an alternative.



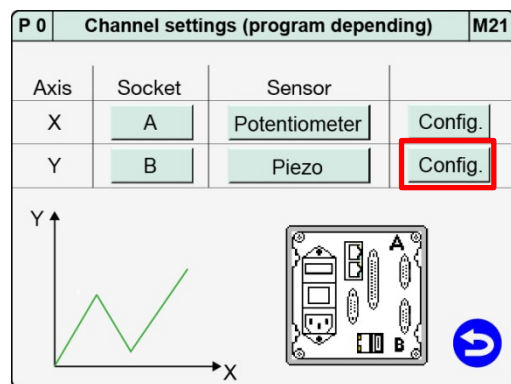

This is how it works

- 1 In measurement mode, tap anywhere on the touchscreen. The  icon appears in the bottom-right corner.
- 2 Tap  to open the "Configuration Main Menu".
- 3 Tap the "Program Setup" icon.
- 4 Tap the "Channel Setup" icon.
- 5 Tap **[Config.]** in the "Y" row.

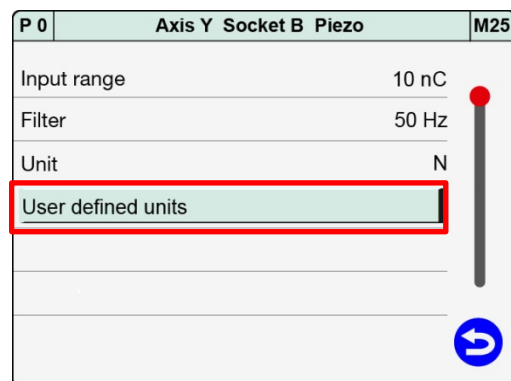

- 6 Tap **[User defined units]**.





- 7 Tap the row in which you want to customize the units and then enter the value via the keypad. The units that you have specified are now displayed under "Unit" in the selection menu.
- 8 Tap  to return to the menu "Y-axis Socket B Piezo".

6.3.2 Measurement mode

In the "Measurement mode" menu (M19) you can specify the signal acquisition parameters for the measurement phase. Essentially the parameters you need to set are the signal sampling, the X-reference for the measurement curve, the curve segment (just the forward curve or the entire measurement curve) and the start/stop condition for the measurement phase.



This is how it works

- 1 In measurement mode, tap anywhere on the touchscreen. The  icon appears in the bottom-right corner.
- 2 Tap  to open the "Configuration Main Menu".
- 3 Tap the "Program Setup" icon.
- 4 Tap the "Measmnt mode" icon.
- 5 In the list of elements, tap the element that you wish to enable, disable or edit, then make the changes you require.
- 6 Tap  to return to the "Program Setup" menu.

The settings that you can make are described in greater detail below.

6.3.2.1 Sampling the measurement channels

The DIGIFORCE® 9311 lets you sample signals using a combination of time interval (Δt), X-interval and Y-interval (ΔX , ΔY). This provides flexibility while also letting you compress the measurement recording. It means that you can use just a few measurement points to record curve regions containing a constant or steadily changing signal, whereas you can use more points when you need to record and reproduce steep signal slopes or alternating waveforms.

Note: When setting the signal sampling, don't forget that there is a maximum memory capacity for the measurement curve data. The DIGIFORCE® 9311 can store a maximum of 5000 value pairs per measurement. Thus with the fastest possible sampling time of 0.1 ms per sample, the curve memory is full after 0.5 s.

Parameters in the "Measurement mode, Sampling" menu (M19)

X sampling	On / Off	Enable/disable
X sample rate	<value input>	Enter the sample interval for the X-channel For values that are less than the channel resolution, the smallest available sample interval is used automatically. Range 0.00001 to 999999
Y sampling	On / Off	Enable/disable
Y sample rate	<value input>	Enter the sample interval for the Y-channel For values that are less than the channel resolution, the smallest available sample interval is used automatically. Range 0.00001 to 999999
t sampling	On / Off	Enable/disable time-based sampling
t sample rate	<value input>	Enter the sampling time interval here Range 0.0001 to 99999.0 seconds

6.3.2.2 Measurement curve reference

The DIGIFORCE® 9311 provides the following X-references for the measurement curve:

Parameters in the "Measurement mode, Reference" menu (M19)

Absolute	Absolute
Final force	Final force
Y ref. line >>	Crossing above Y reference line
Y ref. line <<	Crossing below Y reference line
Y trigger >>	Crossing above Y trigger threshold
Y trigger <<	Crossing below Y trigger threshold

Note: For the "Crossing trigger threshold" reference, the DIGIFORCE® 9311 does not start saving curve data until the trigger event has occurred. The measurement, however, must be started before the trigger event.

Absolute reference

By selecting the "Absolute" setting you are setting the X-axis reference of the measurement curve to the zero point of the currently connected sensor.

You can choose the "Absolute" reference option when you are able to position both parts involved in a joining process with repeat precision, i.e. the workpiece support always positions the workpiece at the same height, and the two parts to be joined (A+B) themselves have negligible tolerances in the insertion direction. In addition, part A must always start in the same position with respect to part B.

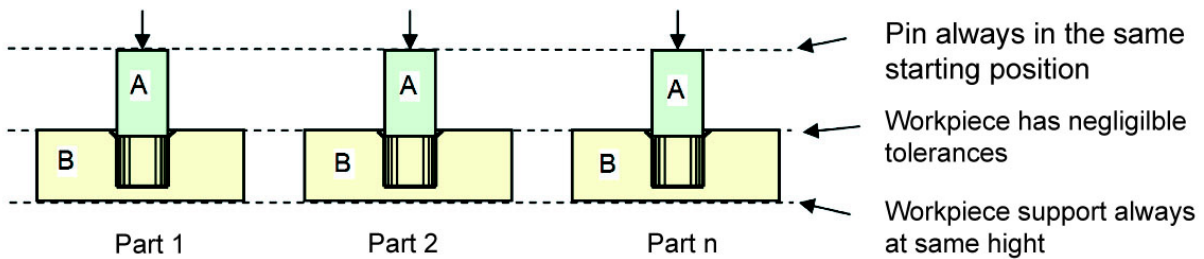

Diagram 42: "Absolute" reference with parts A and B to be joined

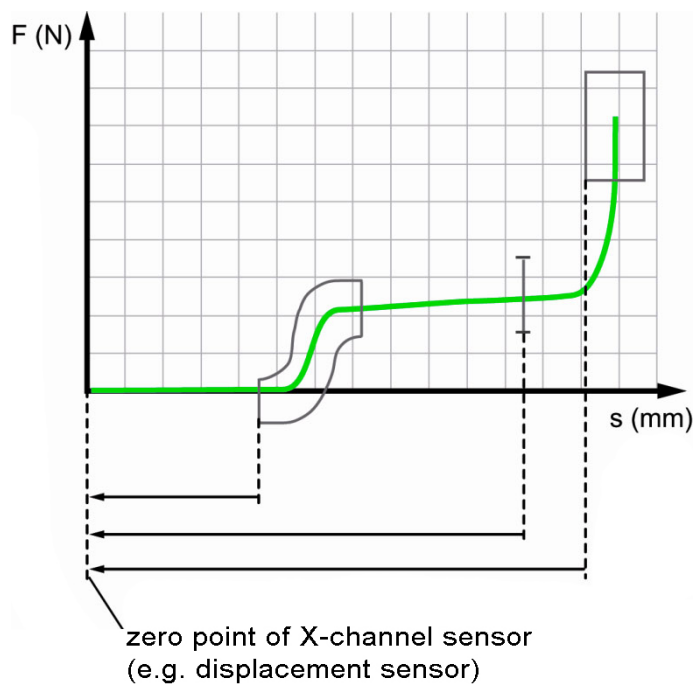

Diagram 43: Example of a measurement curve using the "Absolute" reference

Parameters in the "Measurement mode, Absolute reference" menu (M19)

Reference	Absolute	The DIGIFORCE® 9311 references the measurement curve to the absolute zero point of the measurement system on the X-channel (e.g. displacement sensor).
----	----	Parameter not relevant to the "Absolute" reference

DIGIFORCE® model 9311

Final force reference

With the "Final force" reference (final force used as the reference), the DIGIFORCE® 9311 shifts the curve to after the measurement phase and references it to the X-value of the last measurement point (final force). If a measurement curve contains a forward and return section, the DIGIFORCE® 9311 sets the return point as zero when the reference is set to "Final force".

In joining processes, the end position is known accurately and validated in advance, for instance the depth of the hole in a bearing seat. The press reaches its maximum force at this point. The DIGIFORCE® 9311 then uses this position as the reference value (zero) in the evaluation.

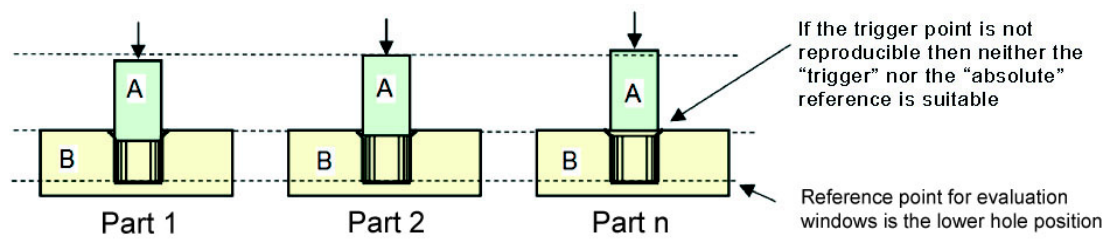

Diagram 44: "Final force" reference with parts A and B to be joined

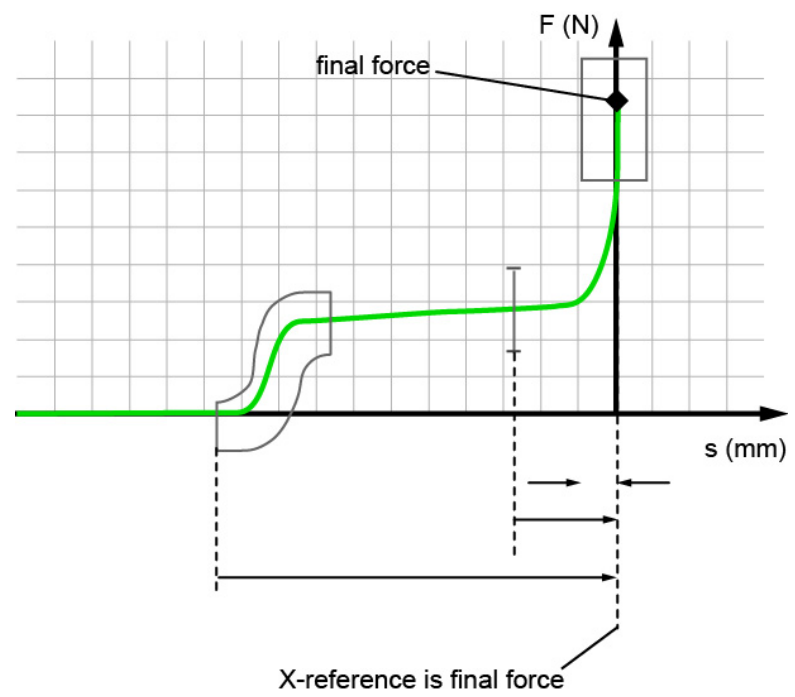

Diagram 45: Example of a measurement curve using the "Final force" reference

Note: In pneumatic or hydraulic presses, for instance, variations in the final force and the associated bending of the mounting system (press frame) may also cause variations in the X-position.

Note: Online evaluation of the "Window" graphical evaluation element is only relevant for the "Absolute" and "Crossing trigger threshold" references. When the "Final force" or "Crossing reference line" reference is used, the measurement curve is recalculated and repositioned after the measurement. In these cases, the online evaluation uses the absolute X-reference for its live response.

Parameters in the "Measurement mode, Final force reference" menu (M19)

Reference	Final force	The last measurement point of the forward measurement curve is the reference point (X = 0). For a forward and return curve, the return point is the reference.
-----	----	Parameter not relevant to the "Final force" reference

Reference: crossing Y reference line

With the "Reference line" reference, the DIGIFORCE® 9311 shifts the curve to after the measurement phase. In this case, the DIGIFORCE® 9311 references the curve to the point at which it crosses a configurable Y reference level.

If the final force in a pneumatic or hydraulic press varies, then using the "Final force" reference would produce a spread in otherwise identical measurement curves. You can eliminate this variation, however, by selecting a reference line that is below the final force of the press.

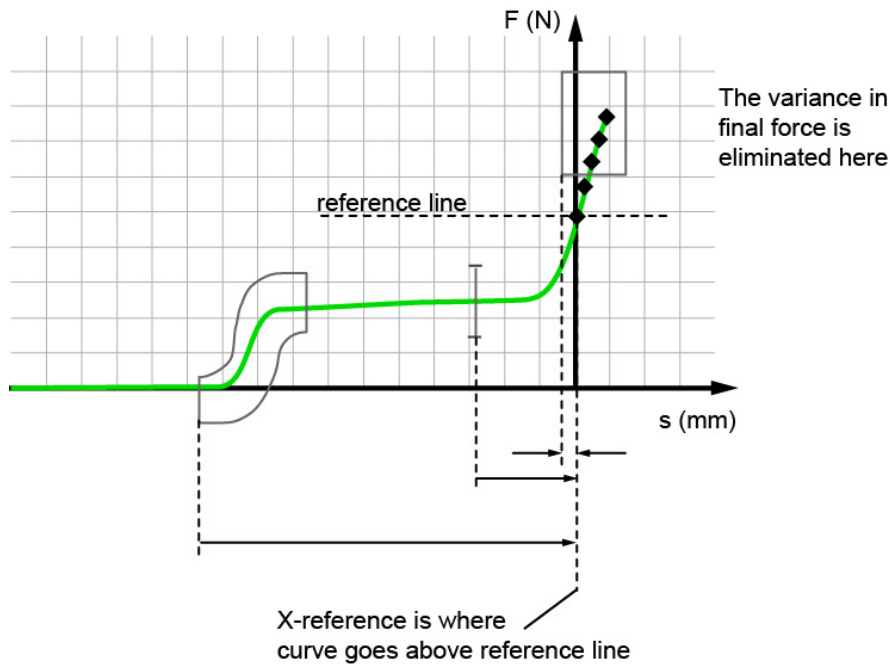

Diagram 46: Example of a measurement curve using the "Reference line" reference

Note: Online evaluation of the "Window" graphical evaluation element is only relevant for the "Absolute" and "Crossing trigger threshold" references. When the "Final force" or "Crossing reference line" reference is used, the measurement curve is recalculated and repositioned after the measurement. In these cases, the online evaluation uses the absolute X-reference for its live response.

Parameters in the "Measurement mode, Crossing ref line reference" menu (M19)

Reference	Y ref. line >> (above reference), Y ref. line << (below reference)	The reference point is where the curve crosses above or below the set Y-level (Y reference line).
Y reference line	<value input>	Use the keypad to enter the value for the Y-level.

Reference: crossing Y trigger threshold

Unlike the "Absolute", "Final force" and "Reference line" references, when the "Trigger" reference is used, recording of the measurement does not start until the measurement crosses the configured threshold (e.g. force threshold). The DIGIFORCE® 9311 writes the value pairs of the measurement curve from this point onwards into the curve memory. Thus the DIGIFORCE® 9311 does not record any curve data in the time period between the start of the measurement phase and the trigger event. The point at which the trigger threshold is crossed acts as the reference point (X = 0) in this case.

The "Trigger" reference helps to eliminate permitted component tolerances from the X/Y curve. For instance when press-fitting a straight pin into a coupling, the force/displacement recording is started when the press head makes contact with the component. The DIGIFORCE® 9311 simultaneously references the force/displacement recording to the configurable contact force.

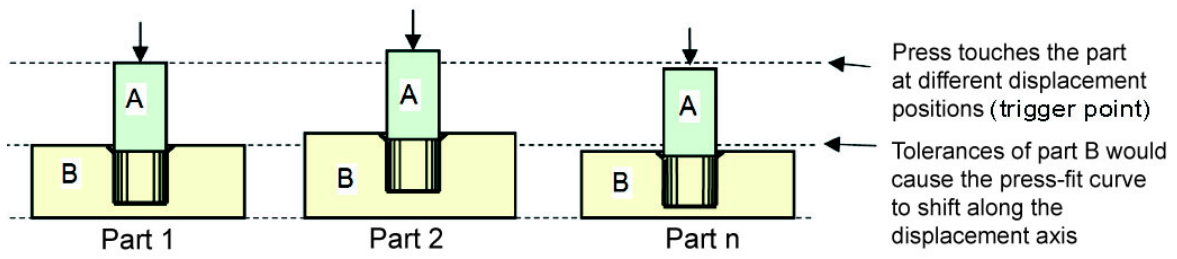

Diagram 47: "Trigger" reference with parts A and B to be joined

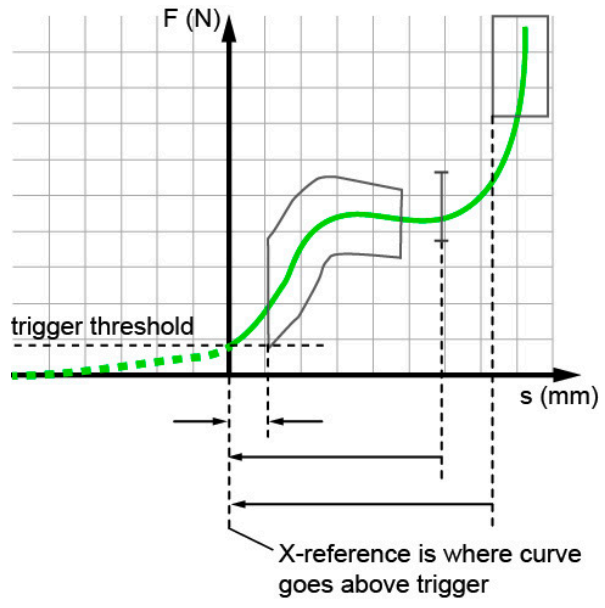

Diagram 48: Example of a measurement curve using the "Trigger" reference

Note: The measurement has to be started before the "Trigger" event is reached!

Parameters in the "Measurement mode, Trigger" menu (M19)

Reference	Y trigger >> (above threshold), Y trigger << (below threshold)	The reference point is where the curve crosses above or below the set Y-level (Y trigger).
Y trigger	<value input>	Use the keypad to enter the value.

6.3.2.3 Curve recording, return point

The DIGIFORCE[®] 9311 divides a recorded measurement curve into two curve segments: a forward segment and a return segment.

You can use the "Record curve to" parameter to select between "Complete curve" and "Return point". Select "Complete curve" to display and evaluate the forward and return segments of the measurement curve. "Return point" means that the DIGIFORCE[®] 9311 displays and evaluates only the forward segment up to the defined return point.

You use the "Return point" parameter to specify which point in the curve is the last value pair of the forward curve, i.e. is the return point. You can choose from "Xmin", "Xmax", "Ymin" and "Ymax". When opting to record the "Complete curve", this return point is marked as a green diamond in the "M1 Graphical meas. curve" displayed in the DIGIFORCE[®] 9311 measurement mode.

Parameters in the "Measurement mode, Return point" menu (M19)

Return point	Xmin, Xmax, Ymin, Ymax	The DIGIFORCE [®] 9311 uses the specified value to determine the last measurement point of the forward curve, i.e. the return point.
Record curve to	Return point / Complete curve	<p>Return point: The DIGIFORCE[®] 9311 displays and evaluates just the forward curve.</p> <p>Complete curve: The DIGIFORCE[®] 9311 displays and evaluates the entire curve (forward and return segments).</p>

Example 1

Setting the return point; recording up to the return point

Record curve to: Return point

Return point: Ymax

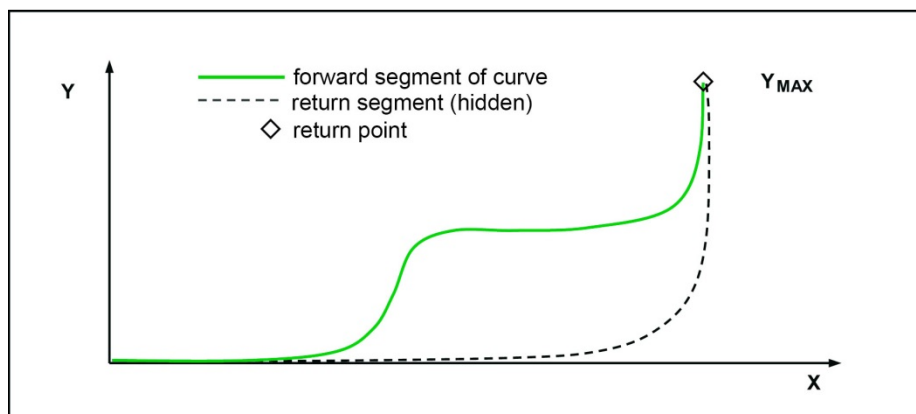

Diagram 49: Example 1: record the curve up to the return point Ymax

DIGIFORCE® model 9311

Example 2

Record curve to: Return point

Return point: Xmax

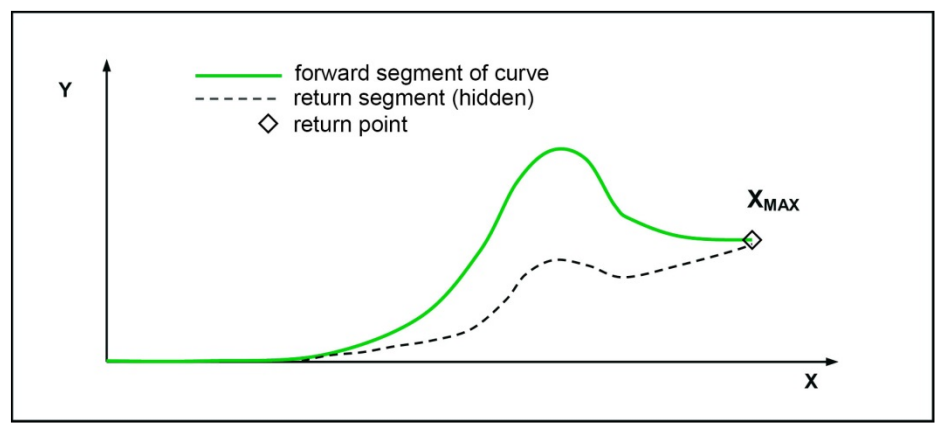

Diagram 50: Example 2: record the curve up to the return point Xmax

6.3.2.4 Start/Stop mode

The DIGIFORCE® 9311 lets you set separate start/stop conditions for recording a measurement curve. Apart from the routine practice of using an external control signal, you can also start or stop a measurement when a sensor signal crosses a defined threshold.

Parameters in the "Measurement mode, Start/Stop mode" menu (M19)

Start mode	External X internal >> (above threshold) X internal << (below threshold) Y internal >> (above threshold) Y internal << (below threshold)	External: The measurement starts on the rising edge of the "IN_START" control signal. X internal, above/below threshold: You also need to define the X-channel start threshold (X start value) Y internal, above/below threshold: You also need to define the Y-channel start threshold (Y start value)
X / Y start value	---- / <value input>	Set here the start-condition threshold if an internal start mode is selected. Use the keypad to enter the value.
Stop mode	External X internal >> (above threshold) X internal << (below threshold) Y internal >> (above threshold) Y internal << (below threshold) Timeout No. of readings	External: The measurement is stopped on the falling edge of the "IN_START" control signal. X internal, above/below threshold: You also need to define the X-channel stop threshold (X stop value) Y internal, above/below threshold: You also need to define the Y-channel stop threshold (Y stop value) Timeout: The measurement only is stopped after the

		<p>specified time has elapsed.</p> <p>Number of readings: The measurement is stopped once the specified number of measurement-value pairs has been recorded.</p>
X / Y stop value; Number of readings	---- / <value input>	<p>Set here the stop-condition threshold if an internal stop mode is selected. Alternatively, if "No.of readings" is selected as the stop event, specify here the number of readings. Use the keypad to enter the value.</p>
Timeout	<value input>	<p>Range: 0.0001 < timeout ≤ 99999 seconds</p> <p>The timeout function for stopping the measurement is always active. You therefore need to enter a suitable time value.</p>

IMPORTANT: The timeout function for stopping the measurement is always active, i.e. even in the "External" stop mode. You therefore always need to enter a suitable time value.

6.3.3 Configuring the evaluation

You have two ways of activating and configuring graphical evaluation elements on the DIGIFORCE[®] 9311.

In the "Select evaluation elements" menu (M10), you can select and enable the graphical evaluation elements and also set their numerical values. This menu, however, does not let you visualize directly how the graphical evaluation element appears and is positioned in the X/Y graph.

All graphical evaluation elements apart from the "Envelope" can be configured by entering numerical values. For an "Envelope" you need at least one measurement curve. (Use the "Graphical test operation" menu (M59) to generate an envelope.)

Alternatively, you can also configure the graphical evaluation elements using the "Graphical test operation" menu (M59) (for further details, please see section 6.3.5 "Graphical test operation" on page 134).

The DIGIFORCE[®] 9311 provides the following graphical evaluation elements:

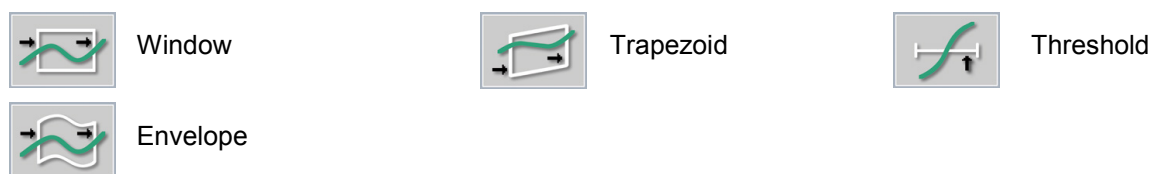



6.3.3.1 Window

One of the most commonly used graphical evaluation elements is the "Window". You can set up to three "Windows" in one measurement program. You define a "Window" (as a rectangle) by its corner points Xmin, Xmax, Ymin and Ymax. You are free to specify how the measurement curve enters and exits the "Window". For instance you can set the "Entry bottom" and "No exit" conditions to monitor the end-position situation in a press-fit process. You can assign an online signal ("OUT_NOK_ONL") to a "Window". The DIGIFORCE[®] 9311 actuates this online signal immediately the curve fails to pass correctly through the window. This lets you intervene directly and quickly in the process as soon as the DIGIFORCE[®] 9311 registers a deviation from the required path of the curve.

The "Window" graphical evaluation element outputs an OK/NOK result at the end of the measurement phase. In addition, the DIGIFORCE[®] 9311 calculates the entry and exit coordinates and the absolute minimum and maximum in the window area.

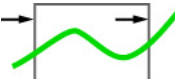
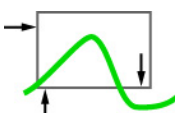
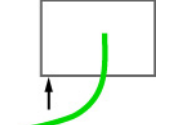

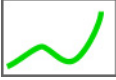
Examples of windows

Symbol	Description
	Window with "Left" entry side and "Right" exit side (pass-through window).
	Window with two entry sides, "Left" or "Bottom", and one exit side, "Bottom" (pass-through window).
	Window with one entry side, "Bottom" (block window).

Symbol	Description
	Window without entry or exit; measurement curve lies entirely inside the window.
	Window without entry or exit; measurement curve lies entirely outside the window (NOT window).

The "Window" graphical evaluation element outputs the following results data:

Individual evaluation

 or 	The DIGIFORCE [®] 9311 can output the evaluation result from a single window only at the Fieldbus interface.
--	---

Entry

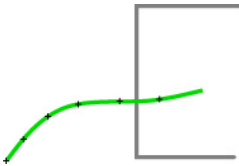
Symbol	Window evaluation element
	<p>The DIGIFORCE[®] 9311 linearly interpolates the window entry coordinates from the last measurement point outside the window and the first measurement point inside the window.</p> <p>If the measurement curve starts inside the window area, the DIGIFORCE[®] 9311 outputs the first measurement point (start value).</p> <p>If the entire measurement curve lies outside the window area, the DIGIFORCE[®] 9311 indicates/outputs the value pair 909090/909090 and displays "<<<>>>" on the screen.</p>

Exit

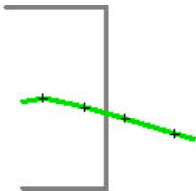
Symbol	Window evaluation element
	<p>The DIGIFORCE[®] 9311 linearly interpolates the window exit coordinates from the last measurement point inside the window and the first measurement point outside the window.</p> <p>If the measurement curve ends inside the window area, the DIGIFORCE[®] 9311 outputs the last measurement point.</p> <p>If the entire measurement curve lies outside the window area, the DIGIFORCE[®] 9311 indicates/outputs the value pair 909090/909090 and displays "<<<>>>" on the screen.</p>

Note: If you have defined an entry side and/or an exit side, at least one value pair must lie inside the window. If this is not the case, the DIGIFORCE[®] 9311 assesses the window with an NOK result.

DIGIFORCE® model 9311

Absolute maximum

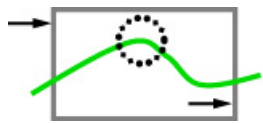
Symbol	Window evaluation element
	<p>The DIGIFORCE® 9311 determines the absolute maximum of the Y-value between entry and exit points as an X/Y value pair.</p> <p>The DIGIFORCE® 9311 only considers curve points inside the window when finding this value.</p>

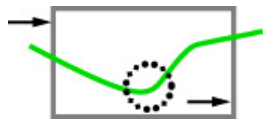

Absolute minimum

Symbol	Window evaluation element
	<p>The DIGIFORCE® 9311 determines the absolute minimum of the Y-value between entry and exit points as an X/Y value pair.</p> <p>The DIGIFORCE® 9311 only considers curve points inside the window when finding this value.</p>

Configuring an evaluation window / Window configuration



This is how it works

- 1 In measurement mode, tap anywhere on the touchscreen. The  icon appears in the bottom-right corner.
- 2 Tap  to open the "Configuration Main Menu".
- 3 Tap the "Program Setup" icon.
- 4 Tap the "Evaluation" icon.
- 5 Tap the "Window" icon.
- 6 Tap "Window" and enter your required window number (1 to 3) via the keypad. You can configure up to three windows.
Note: If the window of that number has already been configured, the data is overwritten when the window is reconfigured.
- 7 Enable the checkbox under "Active" to display additional configuration options.
- 8 Tap "Curve segment" to define the curve segment for which the window is active. You can choose "Forward", "Return" or "Complete curve". Confirm your selection with **[ENTER]**.



- 9 If required, enable "Online evaluation". You can only enable this option for one window. You are then offered the choice of "Off", "Left > Right", "Right > Left", "Bottom > Top" and "Top > Bottom". Confirm your selection with **[ENTER]**.

With Online evaluation enabled, the DIGIFORGE® 9311 switches the online signal ("OUT_NOK_ONL") to active level immediately on detecting that the curve has exited the window incorrectly.

Note: Enabling Online evaluation will change the entry/exit sides previously defined. Enabling Online evaluation is not relevant for the "Final force" or "Crossing reference line" reference. When these references are used, the measurement curve is recalculated and repositioned after the measurement. The live behavior of the Online evaluation is based on the absolute X-reference in these cases.

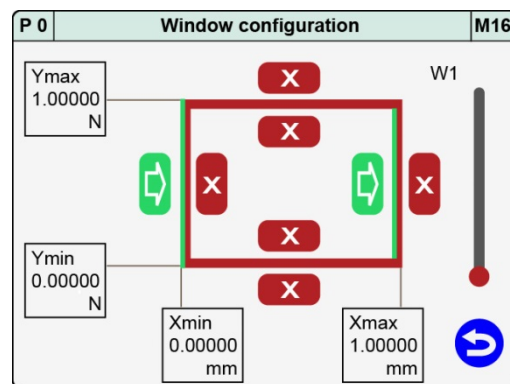
- 10 Tap "Online signal" and specify the active signal level of the PLC I/O signal as either active high ("High active") or active low ("Low active").
- 11 Swipe  the touchscreen to open the second page.
- 12 To set the position and size of the window, tap the fields **[Ymax]**, **[Ymin]**, **[Xmin]** or **[Xmax]** and enter the coordinates using the keypad.



- 13 Tap  or  to set the relevant direction for the entry/exit side(s) of the window. You can select just one side, more than one side or no sides at all. Every possible combination is allowed when setting the entry and exit sides.

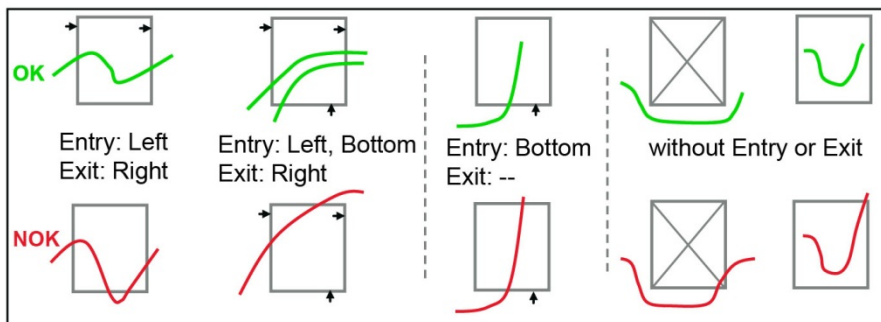

Note: If no side is defined at all, the curve is allowed to lie entirely inside the window or entirely outside the window ("NOT window")

- 14 Tap  to return to the "Select evaluation elements" menu.

Note: Take care that you set the correct curve segment for which the "Window" is active. For instance, if the return point of a forward and return curve lies in the window area, the "Complete curve" option must be selected for the curve segment.

Parameters in the "Window configuration" menu (M16)

Window number	1 to 3	Choice of window 1, 2 or 3
Window	On / Off	Enable/disable
Curve segment	Forward, Return, Complete curve	Specify the curve segment for which the window is active.
Online evaluation	Off Left > Right Right > Left Bottom > Top Top > Bottom	With Online evaluation enabled, the associated online signal goes to active level immediately it is detected that the curve has exited the window incorrectly. The Online evaluation is only permitted for one window. Note: Enabling Online evaluation will change the entry/exit sides previously defined. Online evaluation of the "Window" graphical evaluation element is only relevant for the "Absolute" and "Crossing trigger threshold" references. When the "Final force" or "Crossing reference line" reference is used, the measurement curve is recalculated and repositioned after the measurement. In these cases, the online evaluation uses the absolute X-reference for its live response.
Online signal	High active Low active	Active signal level of the PLC I/O signal ("OUT_NOK_ONL")
Xmin	<value input>	Window position coordinate Xmin
Xmax	<value input>	Window position coordinate Xmax
Ymin	<value input>	Window position coordinate Ymin
Ymax	<value input>	Window position coordinate Ymax
Entry	Left, Right Bottom, Top	Side at which the curve enters the window Possible options: <ul style="list-style-type: none"> • one entry side • more than one entry side • no entry
Exit	Left, Right Bottom, Top	Side at which the curve exits the window Possible options: <ul style="list-style-type: none"> • one exit side • more than one exit side • no exit Note: If no side is defined at all, the curve is allowed to lie entirely inside the window or entirely outside the window ("NOT window")

6.3.3.2 Trapezoid

You can set the "Trapezoid" graphical evaluation element to be of type "Trapezoid X" or "Trapezoid Y". The "Trapezoid X" type is specified by fixed vertical X-limits (Xmin, Xmax) and the "Trapezoid Y" type by fixed horizontal Y-limits (Ymin, Ymax). You can configure up to two trapezoids in one measurement program. At the end of the measurement phase, the DIGIFORCE® 9311 outputs an OK/NOK result and calculates the entry and exit coordinates for each trapezoid.

Unlike a "Window", the measurement curve is only allowed to pass through a "Trapezoid" in one direction, vertical for the trapezoid of type "Trapezoid X" and horizontal for the trapezoid of type "Trapezoid Y".

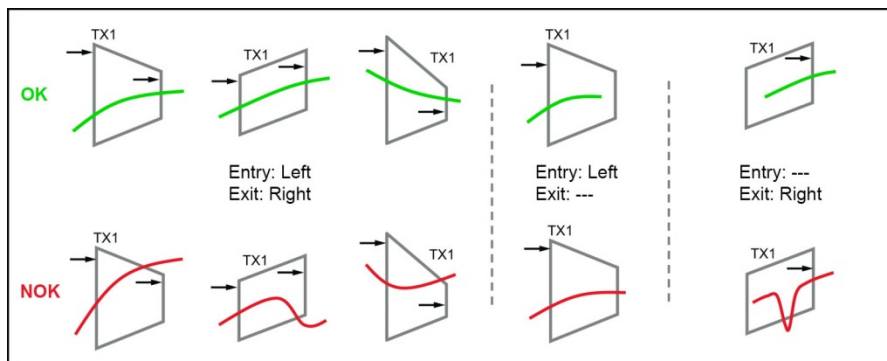

Diagram 51: Examples of "Trapezoid X"

If the trapezoid is of type "Trapezoid Y", however, then the measurement curve must pass from bottom to top or top to bottom.

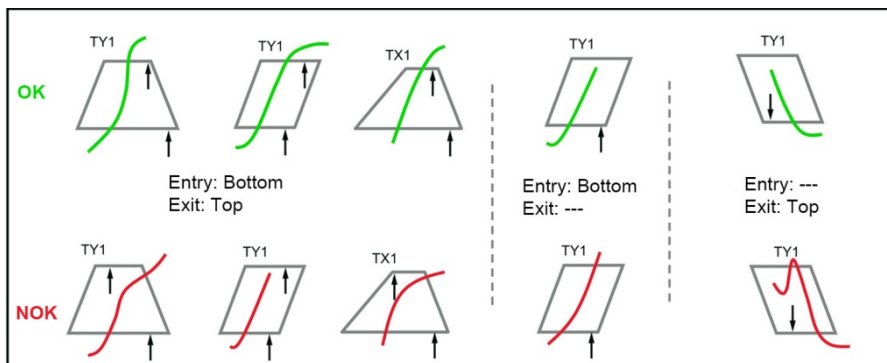



Diagram 52: Examples of "Trapezoid Y"

If the curve passes through the "Trapezoid" concerned in a different direction then this counts as a violation and is assessed as NOK by the DIGIFORCE® 9311.

Whatever its orientation, the "Trapezoid" graphical evaluation element outputs the following results data:

Individual evaluation

	or		<p>The DIGIFORCE® 9311 can only output the evaluation result from a single trapezoid at the Fieldbus interface.</p>
---	----	---	---

DIGIFORCE® model 9311

Entry

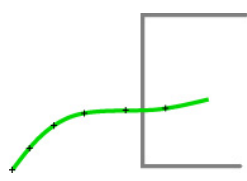
Symbol	Trapezoid evaluation element
	<p>The DIGIFORCE® 9311 linearly interpolates the trapezoid entry coordinates from the last measurement point outside the trapezoid and the first measurement point inside the trapezoid.</p> <p>If the measurement curve starts inside the trapezoid area, the DIGIFORCE® 9311 outputs the first measurement point (start value).</p> <p>If the entire measurement curve lies outside the trapezoid area, the DIGIFORCE® 9311 indicates/outputs the value pair 909090/909090 and displays "<<<>>>" on the screen.</p>

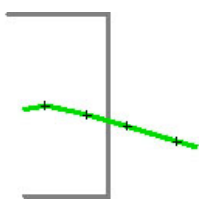

Exit

Symbol	Trapezoid evaluation element
	<p>The DIGIFORCE® 9311 linearly interpolates the trapezoid exit coordinates from the last measurement point inside the trapezoid and the first measurement point outside the trapezoid.</p> <p>If the measurement curve ends inside the trapezoid area, the DIGIFORCE® 9311 outputs the last measurement point.</p> <p>If the entire measurement curve lies outside the trapezoid area, the DIGIFORCE® 9311 indicates/outputs the value pair 909090/909090 and displays "<<<>>>" on the screen.</p>

Note: If you have defined an entry side and/or an exit side, at least one value pair must lie inside the trapezoid. If this is not the case, the DIGIFORCE® 9311 assesses the trapezoid with an NOK result.

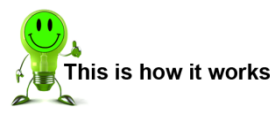
Configuring a trapezoid



- 1 In measurement mode, tap anywhere on the touchscreen. The  icon appears in the bottom-right corner.
- 2 Tap  to open the "Configuration Main Menu".
- 3 Tap the "Program Setup" icon.
- 4 Tap the "Evaluation" icon.
- 5 Tap the "Trapezoid" icon.
- 6 Tap "Trapezoid" and enter your required trapezoid number (1 or 2) via the keypad. You can configure up to two trapezoids.



Note: If the trapezoid of that number has already been configured, the data is overwritten when the trapezoid is reconfigured.
- 7 Enable the checkbox under "Active" to display additional configuration options.
- 8 Tap "Type" to select the type of trapezoid. You have a choice of "Trapezoid X" or "Trapezoid Y".

9 Tap "Curve segment" to define the curve segment for which the trapezoid is active. You can choose "Forward", "Return" or "Complete curve". Confirm your selection with **[ENTER]**.

10 Swipe  the touchscreen to open the second page.

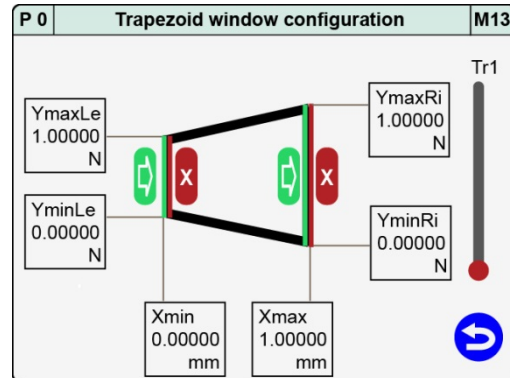

11 If you have selected a trapezoid of type "Trapezoid X", tap the fields **[YmaxLe]**, **[YminLe]**, **[YmaxRi]**, **[YminRi]**, **[Xmin]** and **[Xmax]** and in each case use the keypad to enter the coordinates to specify the position and size of the trapezoid.

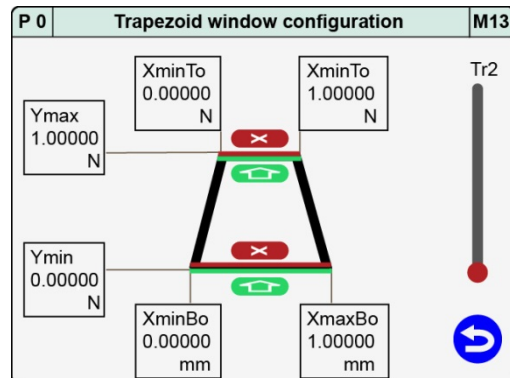

12 Tap  or  to set the relevant direction for the entry and exit sides of the trapezoid.
Note: For trapezoids in the X-direction, you can only choose between right and left as the entry or exit side.

13 If you have selected a trapezoid of type "Trapezoid Y", tap the fields **[Ymax]**, **[Ymin]**, **[XmaxTo]**, **[XminBo]**, **[XmaxTo]** and **[XmaxBo]** and in each case use the keypad to enter the coordinates to specify the position and size of the trapezoid.



14 Tap  or  to set the relevant direction for the entry and exit sides of the trapezoid.
Note: For trapezoids in the Y-direction, you can only choose between top and bottom as the entry or exit side.

15 Tap  to return to the "Select evaluation elements" menu.

Parameters in the "Trapezoid window configuration" menu (M13)

Number	1 or 2	Choice of trapezoid window 1 or 2
Window	On / Off	Enable/disable
Type	Trapezoid X, Trapezoid Y	Select the trapezoid type
Curve segment	Forward, Return, Complete curve	Specify the curve segment for which the trapezoid window is active.
Trapezoid of type X		
Xmin	<value input>	Trapezoid position coordinate Xmin
Xmax	<value input>	Trapezoid position coordinate Xmax
YminLe	<value input>	Trapezoid position coordinate Ymin Left
YminRi	<value input>	Trapezoid position coordinate Ymin Right
YmaxLe	<value input>	Trapezoid position coordinate Ymax Left
YmaxRi	<value input>	Trapezoid position coordinate Ymax Right
Entry	Left, Right	Side at which the curve enters the X trapezoid Possible options: <ul style="list-style-type: none"> • one entry side • more than one entry side • no entry
Exit	Left, Right	Side at which the curve exits the X trapezoid Possible options: <ul style="list-style-type: none"> • one exit side • more than one exit side • no exit
Trapezoid of type Y		
Ymin	<value input>	Trapezoid position coordinate Ymin
Ymax	<value input>	Trapezoid position coordinate Ymax
XminBo	<value input>	Trapezoid position coordinate Xmin Bottom
XminTo	<value input>	Trapezoid position coordinate Xmin Top
XmaxBo	<value input>	Trapezoid position coordinate Xmax Bottom
XmaxTo	<value input>	Trapezoid position coordinate Xmax Top
Entry	Bottom, Top	Side at which the curve enters the Y trapezoid Possible options: <ul style="list-style-type: none"> • one entry side • more than one entry side • no entry

Exit	Bottom, Top	Side at which the curve exits the Y trapezoid Possible options: <ul style="list-style-type: none"> • one exit side • more than one exit side • no exit
-------------	-------------	--

6.3.3.3 Threshold

The "Threshold" graphical evaluation element can be used to calculate and monitor the point at which the measurement curve passes through a defined X-value or Y-value. The DIGIFORCE® 9311 classifies "Thresholds" as two different types. The "X threshold" type is positioned at a set X-value as a vertical line for which you can define the range of Y-values (Ymin to Ymax)

For the "Y threshold" type the situation is exactly the opposite; the threshold is fixed at a set Y-value as a horizontal line for which you can define the range of X-values (Xmin to Xmax). You can use up to two thresholds in one measurement program.

Thresholds provide an OK/NOK result at the end of the measurement phase. If the curve crosses the threshold, the DIGIFORCE® 9311 additionally calculates the coordinates of the crossover point.

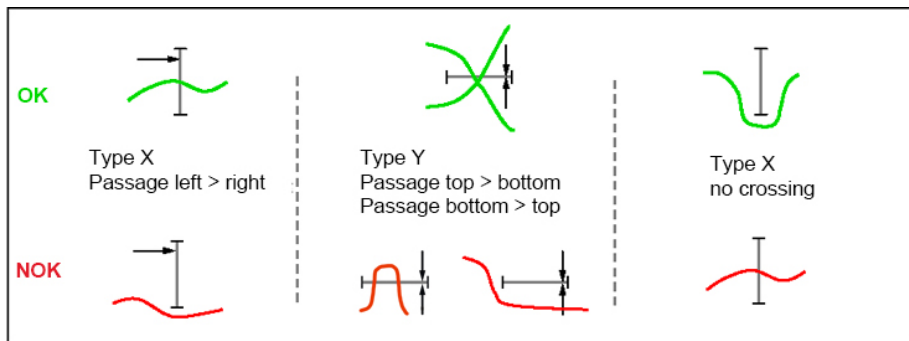



Diagram 53: Examples of thresholds

Note: The evaluation element "Threshold" is only allowed to be passed once.

The "Threshold" graphical evaluation element outputs the following results data:

Individual evaluation

 or 	The DIGIFORCE® 9311 can only output the evaluation result from a single threshold at the Fieldbus interface.
--	--

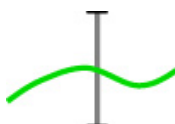

Crossing (intersection of measurement curve and threshold)

Symbol	Threshold evaluation element
	<p>The DIGIFORCE® 9311 linearly interpolates the crossing point from the last measurement point before the threshold and the first measurement point after the threshold.</p> <p>If the DIGIFORCE® 9311 cannot ascertain that the threshold has been crossed, it indicates/outputs the value pair 909090/909090 and displays "<<<<>>>" on the screen.</p>

Configuring a threshold





This is how it works

- 1 In measurement mode, tap anywhere on the touchscreen. The  icon appears in the bottom-right corner.
- 2 Tap  to open the "Configuration Main Menu".
- 3 Tap the "Program Setup" icon.
- 4 Tap the "Evaluation" icon.
- 5 Tap the "Threshold" icon.
- 6 Tap "Threshold" and enter your required threshold number (1 or 2) via the keypad. You can configure up to two thresholds.
Note: If the threshold of that number has already been configured, the data is overwritten when the threshold is reconfigured.
- 7 Enable the checkbox under "Active" to display additional configuration options.
- 8 Tap "Type" to select the type of threshold. You have a choice of "X threshold" or "Y threshold".
- 9 Tap "Curve segment" to define the curve segment for which the threshold is active. You can choose "Forward", "Return" or "Complete curve". Confirm your selection with [ENTER].
- 10 Swipe  the touchscreen to open the second page.

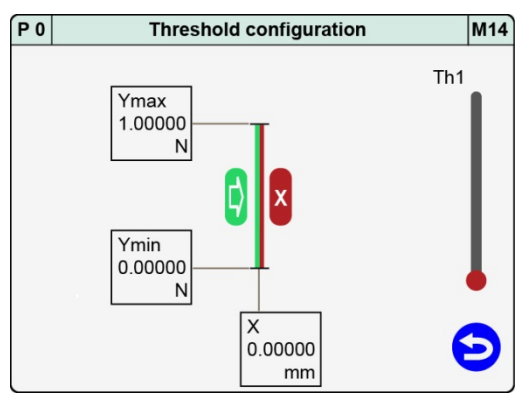

- 11 If you have selected a "Type X threshold", tap the fields [Ymax], [Ymin] and [X] and in each case use the keypad to enter the coordinates to specify the position and size of the threshold.

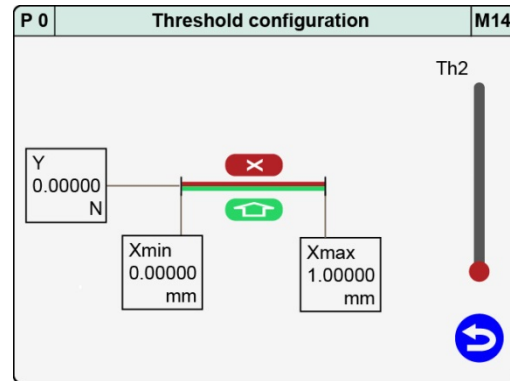

- 12 Tap  or  to set the relevant direction for the entry/exit side of the threshold.
Note: For the "X threshold" type, the measurement curve can cross the threshold from either side (left, right) or from just one side. You can also define that the measurement curve shall not cross the threshold. If this condition is breached, the DIGIFORCE[®] 9311 gives the measurement an NOK evaluation.

- 13 If you have selected a "Type Y threshold", tap the fields **[Y]**, **[Xmin]** and **[Xmax]** and in each case use the keypad to enter the coordinates to specify the position and size of the threshold.



- 14 Tap  or  to set the relevant direction for the entry/exit side of the threshold.
Note: For the "Y threshold" type, the measurement curve can cross the threshold from either side (top, bottom) or from just one side. You can also define that the measurement curve shall not cross the threshold. If this condition is breached, the DIGIFORCE[®] 9311 gives the measurement an NOK evaluation.
- 15 Tap  to return to the "Select evaluation elements" menu.

Parameters in the "Threshold configuration" menu (M14)

Threshold number	1 to 2	Choice of threshold 1 or 2
Threshold	On / Off	Enable/disable
Threshold type	X threshold Y threshold	Select whether the threshold is type X or type Y
Curve segment	Forward, Return, Complete curve	Specify the curve segment for which the threshold is active.
X-value, Y-value	<value input>	For a type X threshold: X-position of the X threshold. For a type Y threshold: Y-position of the Y threshold.
Xmin / Ymin	<value input>	For a type X threshold: Lower Y limit Ymin. For a type Y threshold: Left-hand X limit Xmin.
Xmax / Ymax	<value input>	For a type X threshold: Upper Y limit Ymax. For a type Y threshold: Right-hand X limit Xmax.
Crossing	Left > Right Right > Left Bottom > Top Top > Bottom	Select the direction in which the curve crosses the threshold Possible options: <ul style="list-style-type: none"> • does not cross • crosses from one side • crosses from either side Note: Crossing from either side means either from left to right (bottom to top) or from right to left (top to bottom).

6.3.3.4 Envelopes

The DIGIFORCE® 9311 can generate from one or more measurement curves an "envelope" for each measurement program.

You can generate an "Envelope" only in the "Graphical test operation" menu (M59), where you use at least one existing measurement curve as the basis for the envelope (see section 6.3.5.6 "Graphical Test Operation – Generating an envelope" on page 155). Once you have generated the envelope, you can then adjust its position along the X-axis or Y-axis as required and also set the respective expanded Y/X tolerance band (Delta Ymin/max and Delta Xmin/max respectively).

Note: For a measurement curve comprising a forward and return curve section, the envelope cannot lie over the turning point.

In measurement mode, the DIGIFORCE® 9311 checks whether the measurement curve lies within the defined band of the envelope. If so, the measurement curve is evaluated as OK. If, however, the measurement curve should cross at least once outside the area of the "envelope", the DIGIFORCE® 9311 evaluates the measurement curve as NOK.

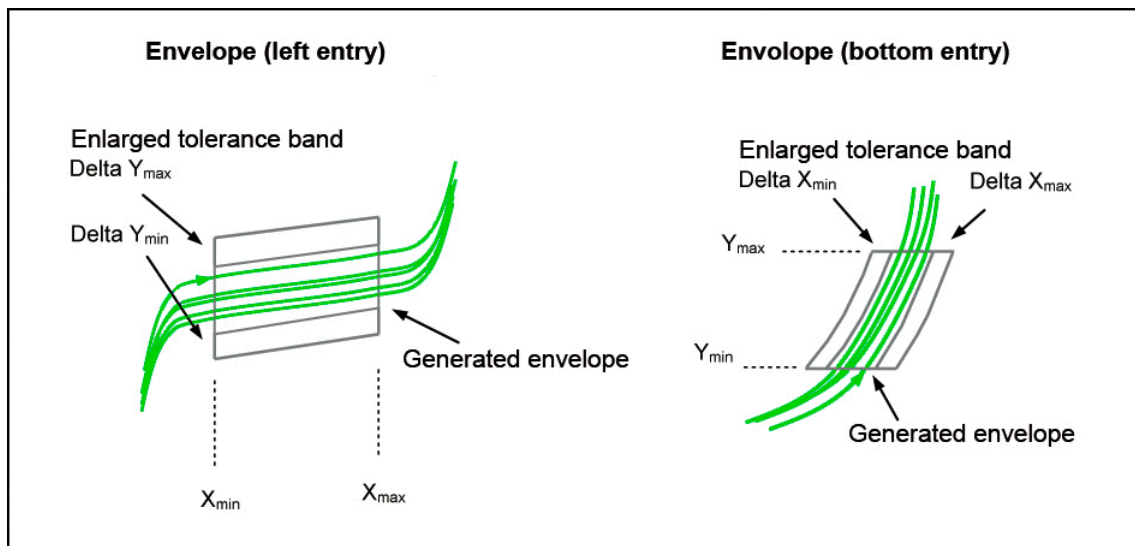
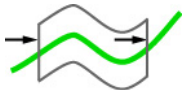
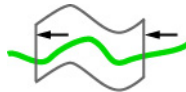



Diagram 54: Envelopes

Examples of envelopes

Symbol	Description
	Envelope with curve crossing from "Left" to "Right".
	Envelope with curve crossing from "Right" to "Left".
	Envelope with curve crossing from "Bottom" to "Top".

Parameters in the menu "Envelope X[mm] Y[N]" (M11)

Envelope	On / Off	Enable/disable
Entry	Left, Right, Top, Bottom	Specify the direction in which the curve passes through the envelope
Curve segment	Forward, Return	Specify the curve segment for which the envelope is active.
Xstart / Ystart	<value input>	Specify the start position of the envelope.
Xend / Yend	<value input>	Specify the end position of the envelope.
Delta Ymin / Xmin	<value input>	Specify the minimum value of the expanded tolerance band, Delta X/Ymin.
Delta Ymax / Xmax	<value input>	Specify the maximum value of the expanded tolerance band, Delta X/Ymax.

IMPORTANT: The DIGIFORCE[®] 9311 can only generate an "Envelope" if the entire curve segment (forward or return) runs in a continuous direction i.e. for a Left or Right entry, only one Y-value must be associated with each X-coordinate, or for a Bottom or Top entry, only one X-value must be associated with each Y-coordinate.

If an error is displayed ("Measurement curve(s) not continuous") when generating the envelope, you can usually obtain a smoother curve by making suitable filter settings or reducing the sampling. Delete the measurement curves that you previously recorded.

6.3.3.5 Tolerance band for evaluation elements

You can use the tolerance band for graphical evaluation elements to configure an additional hysteresis region at the boundaries of the element, so for instance at the entry and exit side of a window. In this hysteresis band, the measurement curve can cross back and forth across the boundary line of the graphical evaluation element any number of times without resulting in an NOK evaluation. For example, if a machine exhibits unwanted mechanical behaviour such as vibrations, or slip-stick phenomena arise in a hydraulic system, then this will intermittently result in fluctuations or outliers in the recorded measurement curve. If these fluctuations occur at the boundaries of an evaluation window, the DIGIFORCE[®] 9311 will evaluate the measurement as NOK if it detects that the curve repeatedly enters and exits the window. By setting a tolerance band, however, the DIGIFORCE[®] 9311 will give an OK evaluation provided the curve fluctuation lies within this hysteresis band.

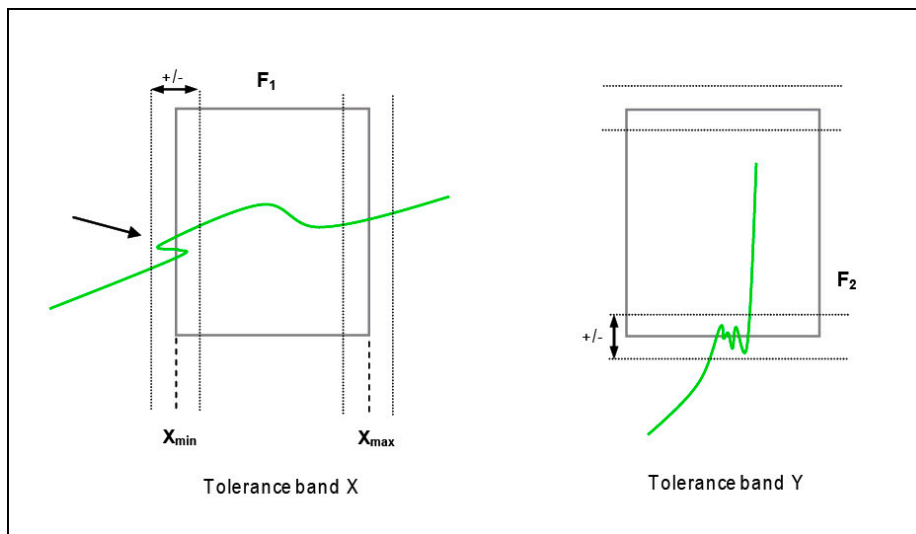





Diagram 55: Tolerance band

Note: The Tolerance band X and Y parameters apply to all the graphical evaluation elements. They cannot be defined for just one specific graphical evaluation element. Note that when a tolerance band is enabled (Tolerance band X or Y > 0), the measurement curve must pass through the area of the graphical evaluation element plus the tolerance value.





This is how it works

- 1 In measurement mode, tap anywhere on the touchscreen. The  icon appears in the bottom-right corner.
- 2 Tap  to open the "Configuration Main Menu".
- 3 Tap the "Program Setup" icon.
- 4 Tap the "Evaluation" icon.
- 5 Tap the "Tol Band" icon.
- 6 Tap "Tolerance band X" and enter the value you require via the keypad.
- 7 Tap "Tolerance band Y" and enter the value you require via the keypad.
- 8 Tap  to return to the "Select evaluation elements" menu.

Parameters in the "Tolerance band" menu (M72)

Tolerance band X	<value input>	Define the hysteresis band in the X-axis direction
Tolerance band Y	<value input>	Define the hysteresis band in the Y-axis direction

6.3.4 Online switching points

	 WARNING
	<p>NOT a substitute for safety devices and protective equipment</p> <p>The online switching signals S1 to S6 are NOT a substitute for safety devices and protective equipment.</p> <p>Use safety devices and protective equipment.</p>

Note: The switching signals S1 to S6 do not meet the requirements for a safety switch. It is the responsibility of the owner of the complete system, such as a press, to equip the system with the required safety devices and protective equipment.

Note: Outputs S1 and S2 are permanently assigned to specific PLC outputs. The assignment for outputs S3 to S6 can be custom-set (see section 6.1.2 "PLC outputs" on page 46).

The six switching signals S1 to S6 at the PLC I/O interface and/or Fieldbus interface can be used for signalling in real time if a limit has been exceeded. In the "Setup realtime switchpoints" menu (M12), you can assign the six signals to the active measurement channels X or Y and set the limit threshold. You can also select for each I/O signal whether it is active high or active low.

The limit thresholds for the X measurement channel can refer to the absolute measurement signal or to the relative zero point (Measurement mode reference: Y trigger). The DIGIFORCE® 9311 only activates the switching signals in "Measurement mode" and "Test operation".

P 0	Setup realtime switchpoints			M12
S1	X	5.00000	mm	
	ActiveHigh	Refer:Absolute		
S2	Y	10.000	N	
	Active Low			
S3	X	15.0000	mm	
	ActiveHigh	Refer:Absolute		

Diagram 56: Setting the online switching points



DIGIFORGE® model 9311

Parameters in the menu "Setup realtime switchpoints S1 to S6" (menu 12)

Value	Limit threshold	Enter the limit threshold
Units	Units display	Displays the units for the measurement channel
Channel	X, Y	Select the active measurement channel for the respective switching signals S1 to S6
Active	High / Low	Select whether signal is active high or active low
Reference	Absolute / Y trigger	Reference for measurement channel X Absolute: The limit threshold is referred to the absolute value of measurement channel X. Y trigger: The limit threshold is referred to the trigger event (for further details, please see section 6.3.2.2 "Measurement curve reference" on page 107).

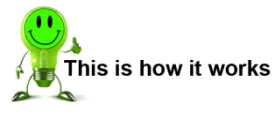
Note: You can only select the Y trigger reference if the "Reference" parameter in the "Measurement mode" menu is set to Y-Trigger (overrun or underrun).



- 1 In measurement mode, tap anywhere on the touchscreen. The  icon appears in the bottom-right corner.
- 2 Tap  to open the "Configuration Main Menu".
- 3 Tap the "Program Setup" icon.
- 4 Tap the "Switchpoints" icon.
- 5 The two-page menu that opens outlines in red those fields that can be edited for the switching points S1 to S6. To edit the setting, tap the relevant field and hence change the selected setting. You can also use the keypad to enter values.

Note: You can only select the Y trigger reference if crossing the Y trigger threshold (Y trigger >> or Y trigger <<) is set as the "Reference" parameter in the "Measurement mode" menu.

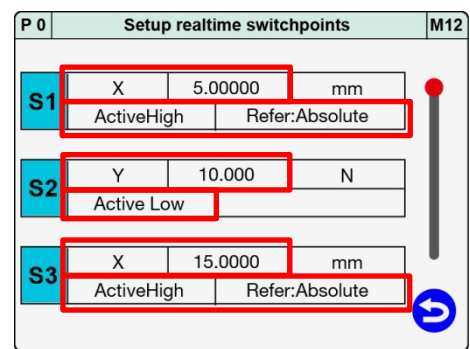

Note: Outputs S1 and S2 are permanently assigned to specific PLC outputs. The assignment for outputs S3 to S6 can be custom-set (see section 6.1.2 "PLC outputs" on page 46).

6.3.5 Graphical test operation

In the "Graphical test operation" menu (M59) you can perform measurements in one or more measurement programs and use the recorded measurement curve(s) to define the graphical evaluation elements such as "Window", "Trapezoid", "Threshold" and "Envelope". The 10 most recent measurement results from each measurement program are saved. You can select **[CrvArray]** to display this set of recorded measurement curves as a curve array. When calculating an envelope, the DIGIFORCE® 9311 uses these measurement curves as the basis for generating the "Envelope".

Note: Note that on activation of the "IN_AUTO" control input, the "Graphical test operation" menu (M59) will close automatically and the DIGIFORCE® 9311 will switch to measurement mode. In "Graphical test operation", the other PLC I/O control signals respond in exactly the same way as in measurement mode, and the online switching points are also active.

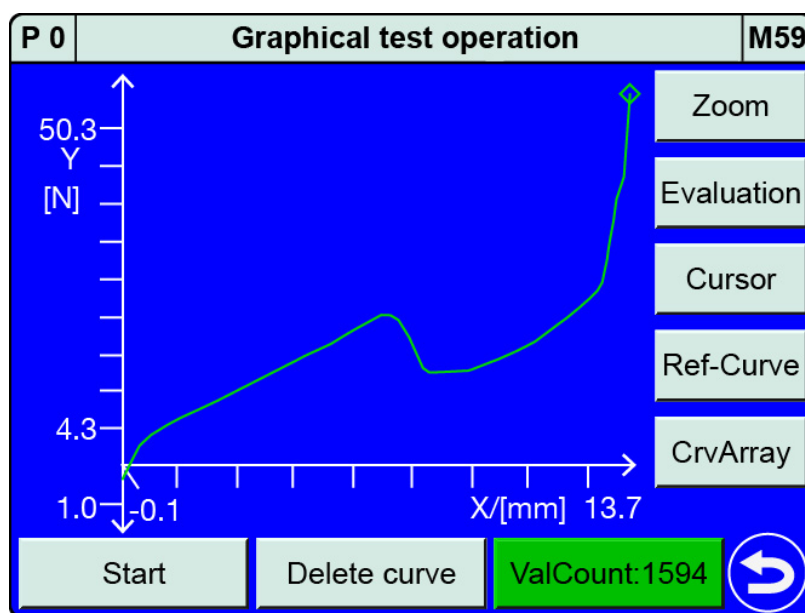

Diagram 57: Graphical test operation



The following functions are available in the "Graphical test operation" menu (M59):

- Run measurements
- Adjust the scale of the measurement curve graph **[Zoom]**
- Configure evaluation elements **[Evaluation]**
- Take readings from the measurement curve using the **[Cursor]**
- Enable a measurement curve as the reference curve **[Ref-Curve]**
- Show/Hide the curve array view **[CrvArray]**
- External control (start measurement, change program, tare, sensor test, ...)



DIGIFORCE® model 9311



This is how it works

- 1 In measurement mode, tap anywhere on the touchscreen. The  icon appears in the bottom-right corner.
- 2 Tap  to open the "Configuration Main Menu".
- 3 Tap the "Program Setup" icon.
- 4 Tap the "Graph. TestOp." icon.
- 5 Tap  to return to the "Program Setup" menu.

Graphical test operation – Main dialog window

With the "Zoom" > "Auto" setting, you can move the measurement curve by swiping  or 

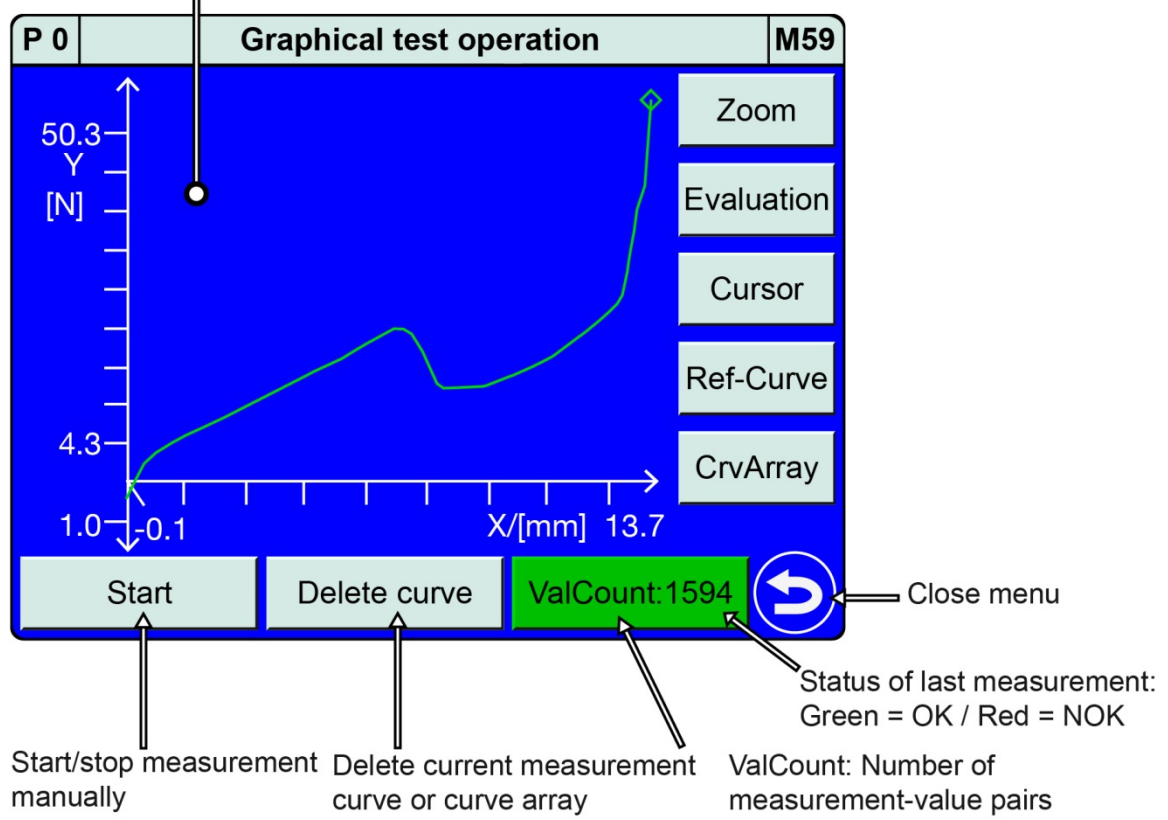

Diagram 58: Graphical test operation – Main dialog window

6.3.5.1 Graphical Test Operation - Zoom (adjust zoom for X/Y graphs)

You can set the zoom (scale) for the X/Y-axes of the measurement curve graph in the "Graphical test operation" menu (M59), with a choice of "Auto" or "FixScale" zoom modes. In "Auto" mode, the axes are scaled so that the entire measurement curve is visible including all the active graphical evaluation elements such as "Window", "Trapezoid", "Threshold" and "Envelope". The zoom may vary in this case from measurement to measurement. If you want a fixed scale for the X/Y graphs, select the "FixScale" zoom mode and specify the Min/Max values for the axes using the parameters [Xmin], [Xmax], [Ymin] and [Ymax].

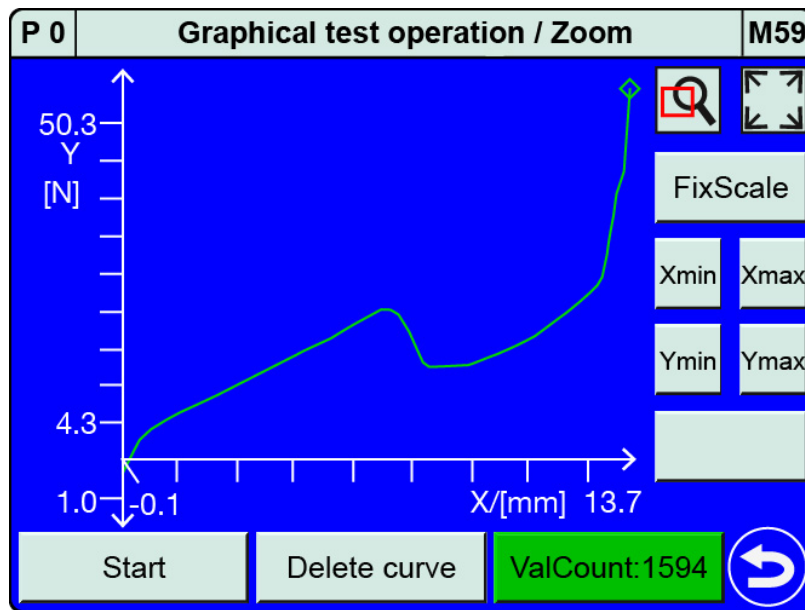



Diagram 59: Graphical test operation – Zoom

You can use the magnifying glass  as a particularly easy way to select a region of the graph that you want to magnify. To set the area for magnification, drag your finger from top left to bottom right of this region on the touchscreen.

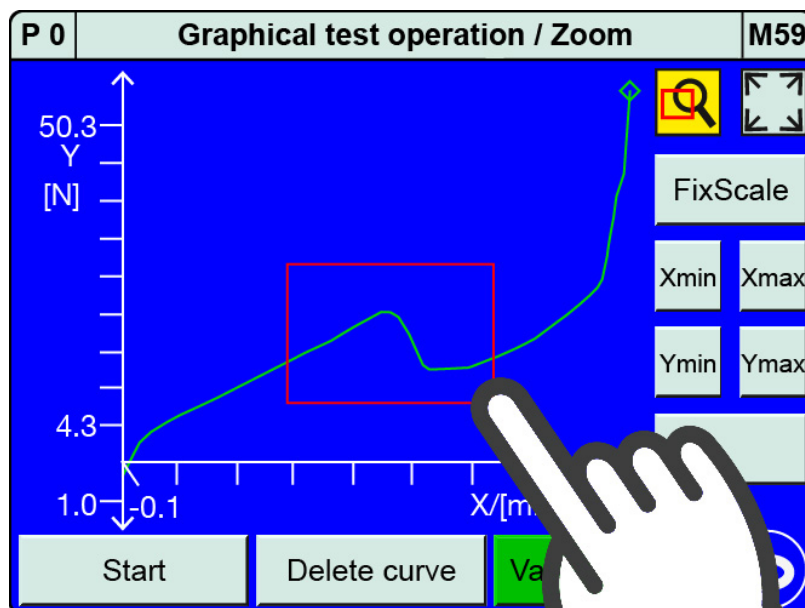





Diagram 60: Magnifying a region of the graph

DIGIFORCE[®] model 9311

Note: If "Auto" zoom mode is enabled, then any region that you have selected for magnification is reset when you close the "Graphical test operation" menu (M59).

Tapping AutoSize  will redisplay the entire measurement curve including all the active evaluation elements.

 **This is how it works**

- 1 In measurement mode, tap anywhere on the touchscreen. The  icon appears in the bottom-right corner.
- 2 Tap  to open the "Configuration Main Menu".
- 3 Tap the "Program Setup" icon.
- 4 Tap the "Graph. TestOp." icon.
- 5 Tap **[Zoom]**.
If **[Zoom]** is set to **[Auto]**, tap **[Auto]** to switch to **[FixScale]**.

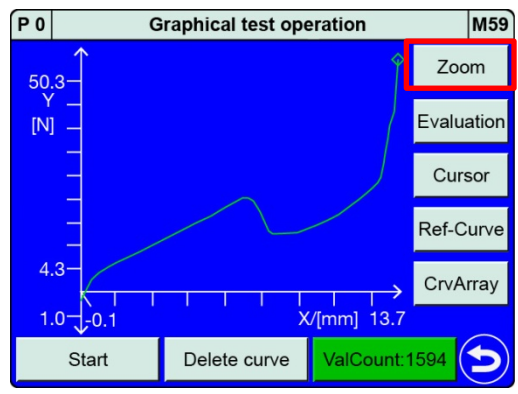

- 6 Tap the magnifying glass, which then turns yellow. Drag your finger over the touchscreen from top left to bottom right of the area that you want to magnify. Remove your finger once you have defined the area, which is then shown magnified.

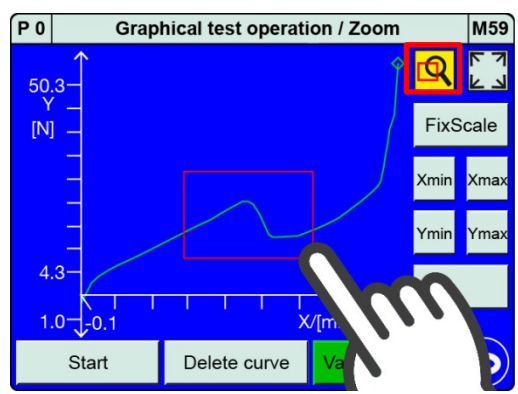

- 7 Tap AutoSize to display the entire measurement curve including all the graphical evaluation elements.

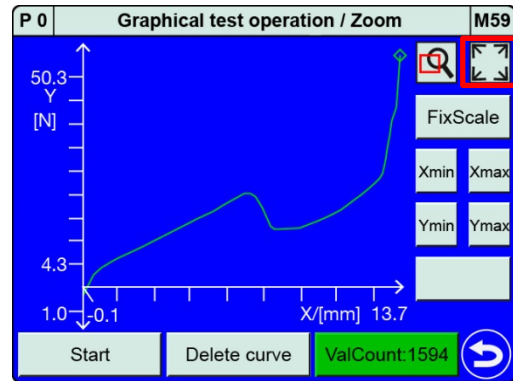

- 8 Tap  to return to the "Graphical test operation" menu.

6.3.5.2 Graphical test operation – AutoSet

Once you have recorded a measurement curve in measurement mode or in the "Graphical test operation" menu (M59), the DIGIFORCE® 9311 displays the **[AutoSet]** button, which can be used to place automatically two "Window" graphical evaluation elements. This AutoSet function positions one "Window" in the centre of the displacement range (X-range) and the other "Window" at the end of the forward curve (end-point region). Then you simply need to set the entry and exit sides and make any fine adjustments you require to the limits.

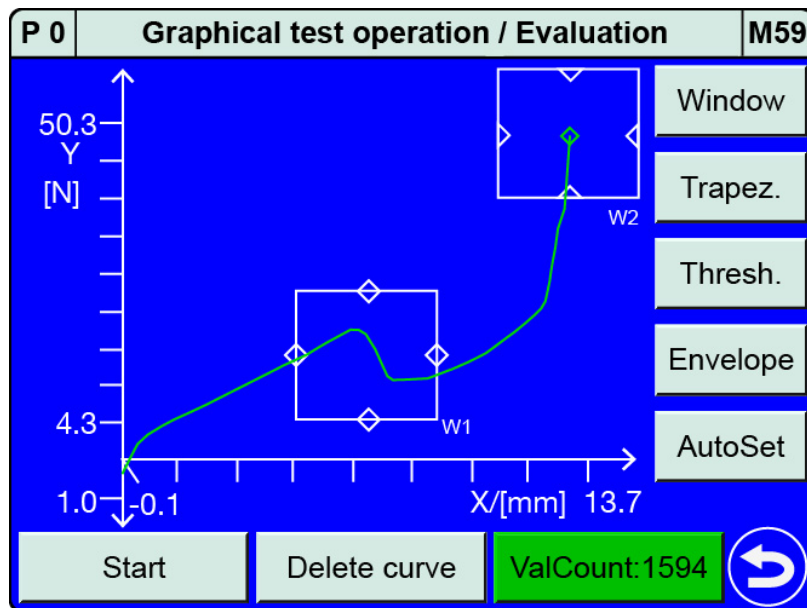



Diagram 61: Graphical test operation – AutoSet

DIGIFORCE® model 9311



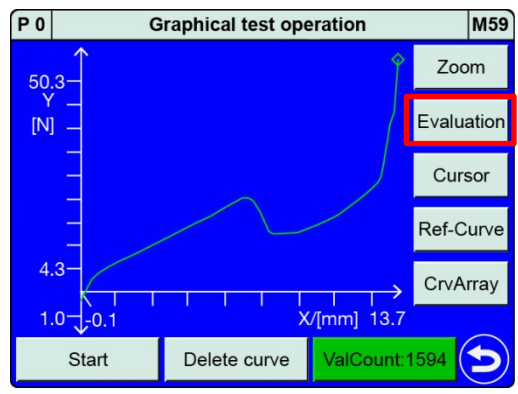

This is how it works

- 1 In measurement mode, tap anywhere on the touchscreen. The  icon appears in the bottom-right corner.
- 2 Tap  to open the "Configuration Main Menu".
- 3 Tap the "Program Setup" icon.
- 4 Tap the "Graph. TestOp." icon.
- 5 Tap **[Evaluation]**.

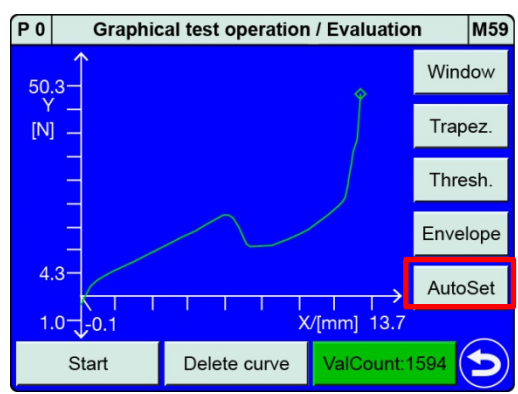

- 6 Tap **[AutoSet]**. This opens the "Window configuration" menu for Window 1.
Note: The **[AutoSet]** function disables all the active graphical evaluation elements and repositions Windows 1 and 2 on the current measurement curve.



- 7 Confirm your settings by tapping . This opens the "Window configuration" menu for Window 2.
- 8 Confirm your settings by tapping . This takes you to the "Graphical test operation / Evaluation" menu, where you can see the two windows.

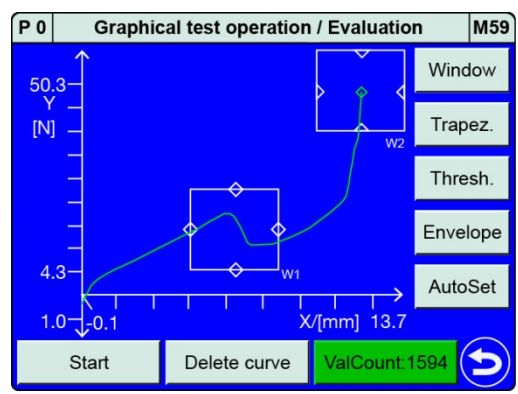

- 9 If required, specify the entry and exit sides for the windows and adjust the window positions. For further details, please see section 6.3.3.1 "Window" on page 115.

6.3.5.3 Graphical Test Operation – Configuring a window

In the "Graphical test operation" menu (M59) you can enable the "Window" graphical evaluation element and place it, move it and change its size directly in the measurement curve graph. To access the full set of parameters, you can switch to the "Window configuration" menu (M16); for details, please see section 6.3.3.1 "Window" on page 115.

Note: When a "Window" graphical evaluation element is activated for the first time, it has the following default settings:

Entry	Left
Exit	Right
Curve segment	Forward
Xmin	0.0
Xmax	1.0
Ymin	0.0
Ymax	1.0

You can use **[AutoSize]** to fit the Window size initially to the current graph scale. You can then adjust the size by changing the limits.

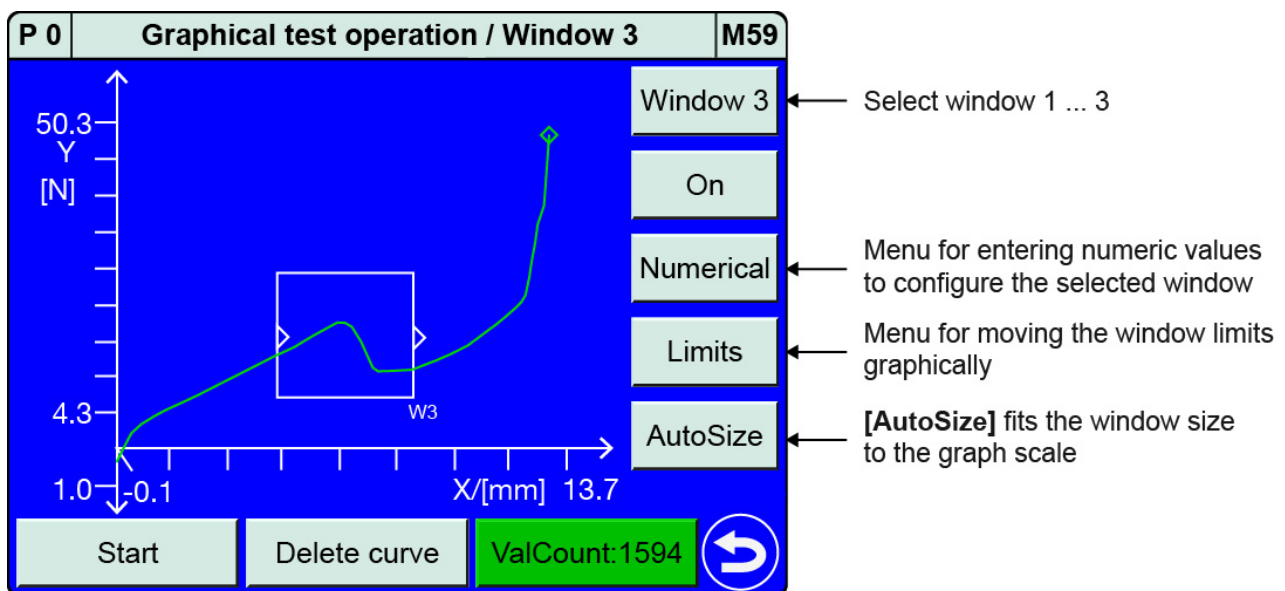



Diagram 62: Graphical Test Operation – AutoSize Window

DIGIFORCE® model 9311



This is how it works

- 1 In measurement mode, tap anywhere on the touchscreen. The  icon appears in the bottom-right corner.
- 2 Tap  to open the "Configuration Main Menu".
- 3 Tap the "Program Setup" icon.
- 4 Tap the "Graph. TestOp." icon.
- 5 Tap [Evaluation].

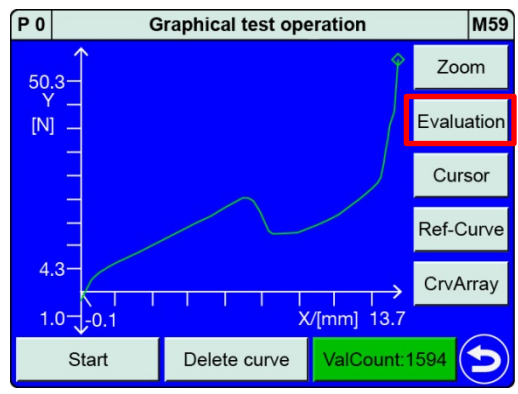

- 6 Tap [Window] and select your required window number (1 to 3). Tap [Off] to activate the window.

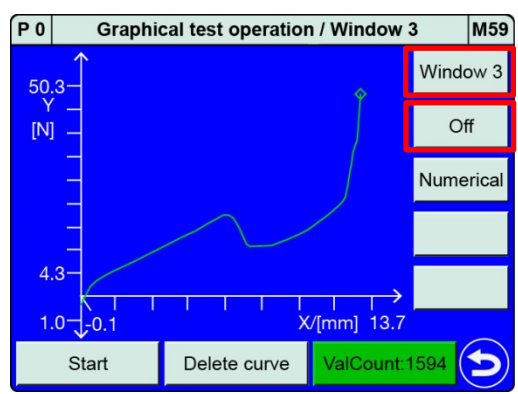

- 7 The window is placed on the measurement curve.

Note: The defaults settings are:
 Entry = Left, Exit = Right,
 Curve segment = Forward,
 Xmin = 0.0, Xmax = 1.0,
 Ymin = 0.0 and Ymax = 1.0.

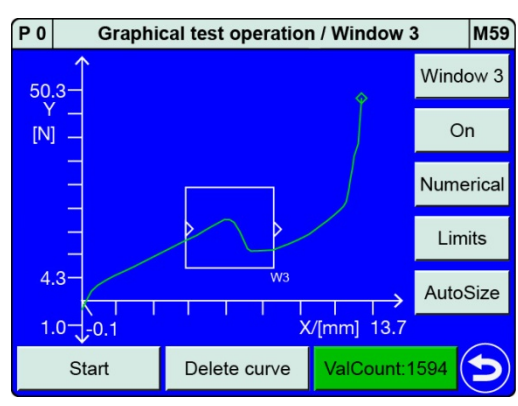

Configuring a window - Numerical

Tap **[Numerical]** to open the "Window configuration" menu (M16) for the previously selected window. For details of the possible settings, please refer to section 6.3.3.1 "Window" on page 115.

Configuring a window - Limits

If you tap **[Limits]**, you can change the position and size of the selected window directly on the touchscreen using your finger.

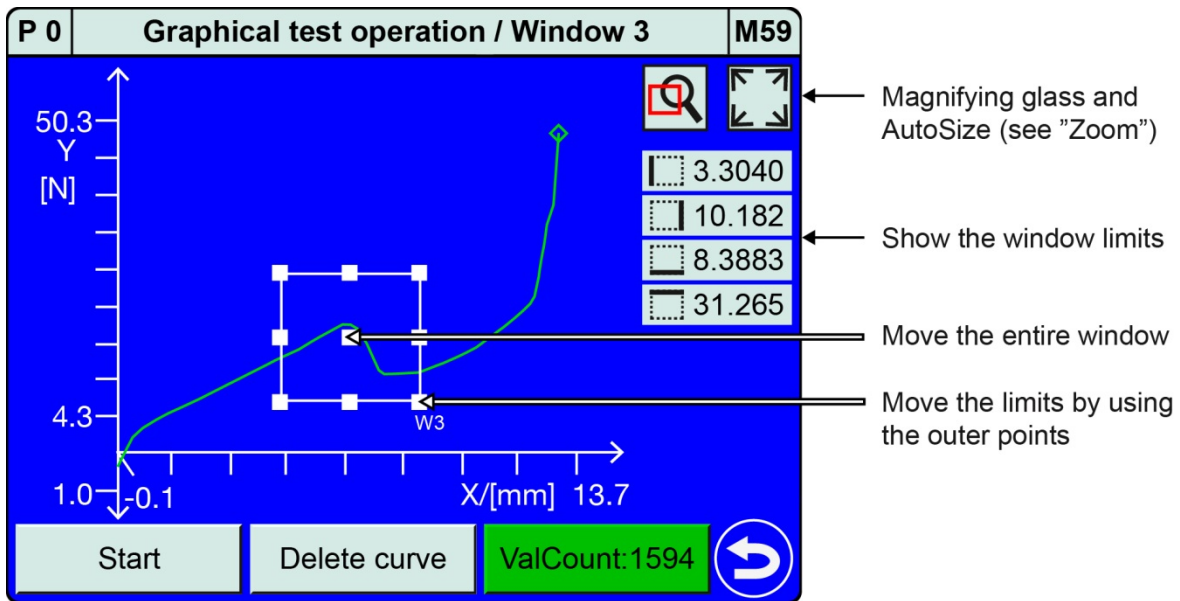

Diagram 63: Graphical Test Operation – Window Limits



This is how it works

- 1 Tap **[Limits]** in the "Graphical test operation / Window 1 to 3" menu.

Note: You can zoom into the curve to help you set the limits. Swipe the displayed curve detail to move its position. Then you need to select the entry/exit sides and the valid curve segment under **[Numerical]**.

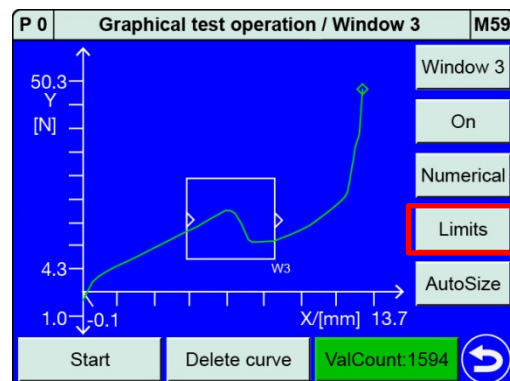

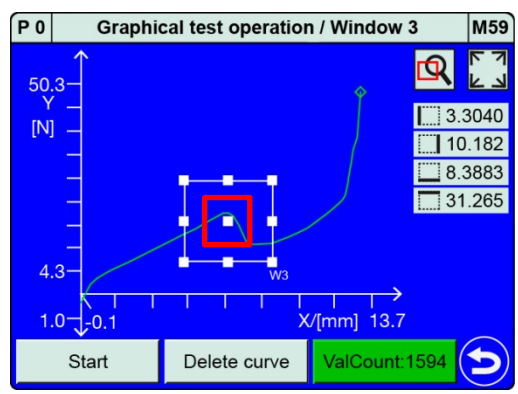

DIGIFORCE® model 9311

- 2 Place your finger in the centre of the window and drag it in the direction in which you want to move the window.

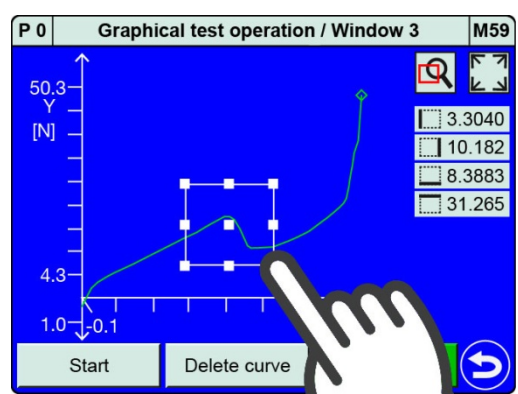

- 3 Place your finger on one of the corners and drag it across the touchscreen to change the limits.



- 4 Tap  to close the setup.

Configuring a window - AutoSize

You can use **[AutoSize]** to fit the Window size initially to the current graph scale. You can then choose to adjust the size by changing the limits. You can adjust the limits either as described in "Configuring a window – Limits" in section 6.3.5.3 "Graphical Test Operation – Configuring a window" on page 140 or in the "Window configuration" menu as described in section 6.3.3.1 "Window" on page 115.

Note: If you are configuring a graphical evaluation element for a measurement curve with a forward and return segment, make sure you assign the correct curve segment to the element ("Forward", "Return" or "Complete curve"). To specify the curve segment, open the "Window configuration" menu (M16) using the **[Numerical]** button.



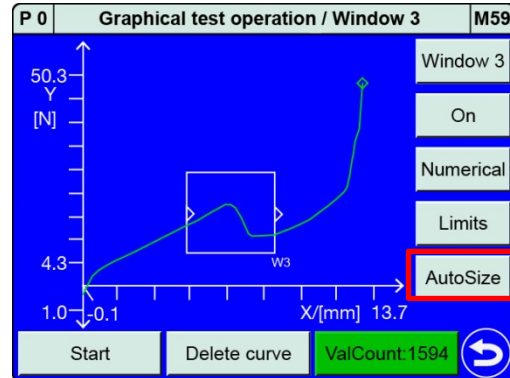

This is how it works

- 1 In "Graphical test operation / Window 1 to 3" tap **[AutoSize]** to adjust the size of the window.

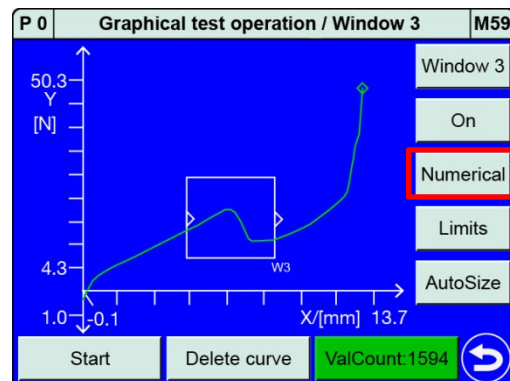

- 2 Tap **[Numerical]** to open the "Window configuration" menu and then set the correct "Curve segment". You have a choice of "Forward", "Return" or "Complete curve".



- 3 Tap  to return to the "Graphical test operation / Window 1 to 3" menu.

6.3.5.4 Graphical Test Operation – Configuring a trapezoid

In the "Graphical test operation" menu (M59) you can enable the "Trapezoid" graphical evaluation element and place it, move it and change its size directly in the measurement curve graph. To access the full set of parameters, you can switch to the "Trapezoid window configuration" menu (M13); for details, please see section 6.3.3.2 "Trapezoid" on page 120.

Note: When a "Trapezoid" graphical evaluation element is activated for the first, it has the following default settings:

Type	Trapezoid X
Entry	Left
Exit	Right
Curve segment	Forward
Xmin	0.0

Xmax	1.0
YminLe	0.0
YmaxLe	1.0
YminRi	0.0
YmaxRi	1.0

You can use **[AutoSize]** to fit the Trapezoid size initially to the current graph scale. You can then adjust the size by changing the limits.

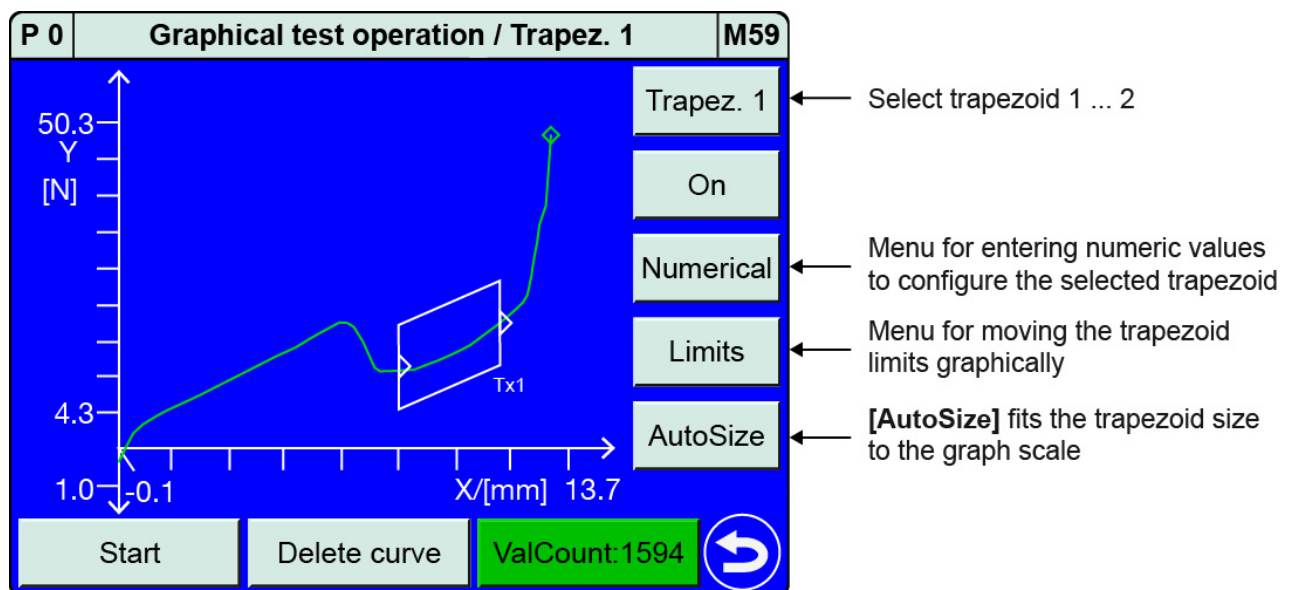

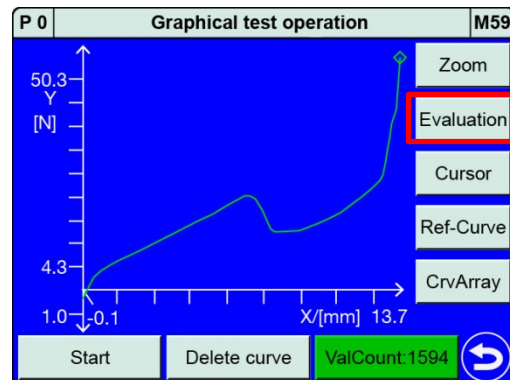

Diagram 64: Graphical Test Operation – Trapezoid AutoSize



This is how it works

- 1 In measurement mode, tap anywhere on the touchscreen. The  icon appears in the bottom-right corner.
- 2 Tap  to open the "Configuration Main Menu".
- 3 Tap the "Program Setup" icon.
- 4 Tap the "Graph. TestOp." icon.
- 5 Tap **[Evaluation]**.



- 6 Tap **[Trapez.]** and select your required trapezoid number (1 or 2). Tap **[Off]** to activate the trapezoid.

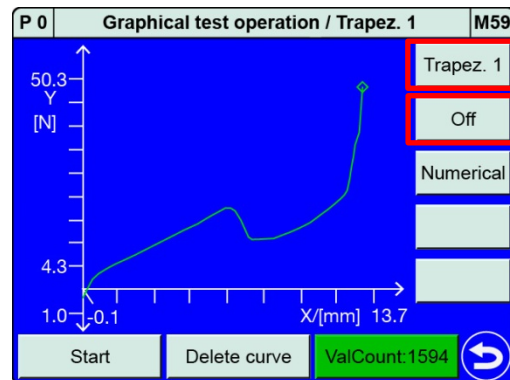

- 7 The trapezoid is placed on the measurement curve.

Note: The defaults settings are:
 Type = Trapezoid X,
 Entry = Left, Exit = Right,
 Curve segment = Forward,
 Xmin = 0.0, Xmax = 1.0,
 YminLe = 0.0, YmaxLe = 1.0,
 YminRi = 0.0 and YmaxRi = 1.0.

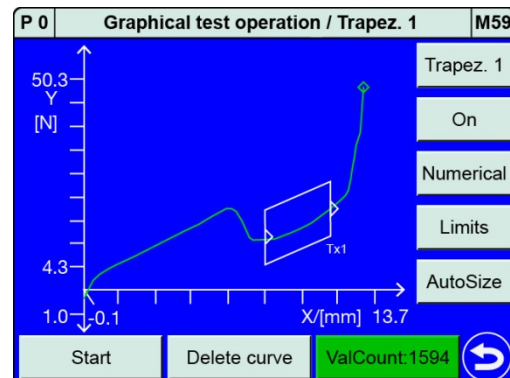

Configuring a trapezoid - Numerical

Tap **[Numerical]** to open the "Trapezoid window configuration" menu (M13) for the previously selected trapezoid. For details of the possible settings, please refer to section 6.3.3.2 "Trapezoid" on page 120.

Select here whether you want to use a "Trapezoid X" or "Trapezoid Y" as the trapezoid type.

Configuring a trapezoid - Limits

If you tap **[Limits]**, you can change the position and size of the selected trapezoid directly on the touchscreen using your finger.

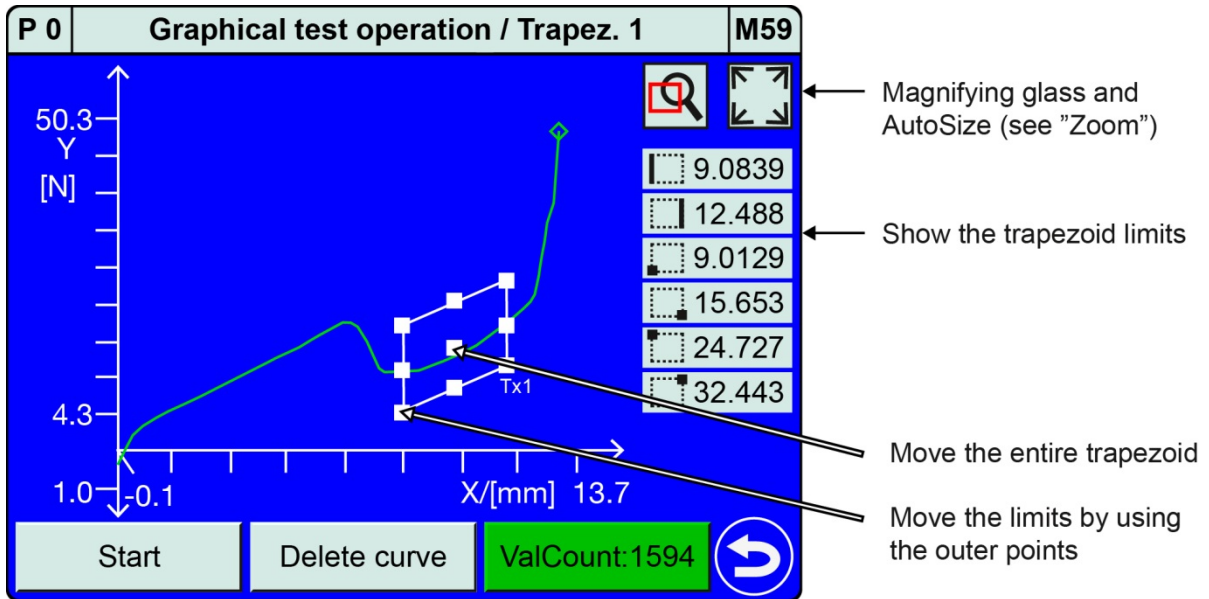
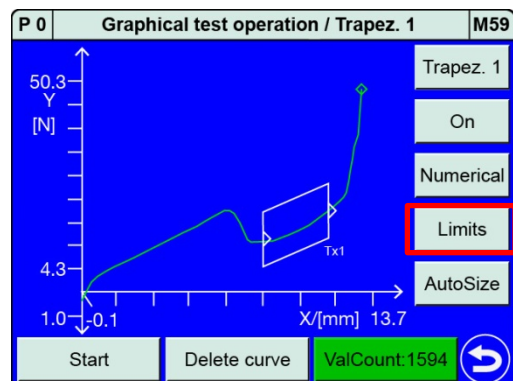

Diagram 65: Graphical Test Operation – Trapezoid Limits



This is how it works

- 1 Tap **[Limits]** in the "Graphical test operation / Trapezoid 1 or 2" menu.



- Place your finger in the centre of the trapezoid and drag it in the direction in which you want to move the trapezoid.

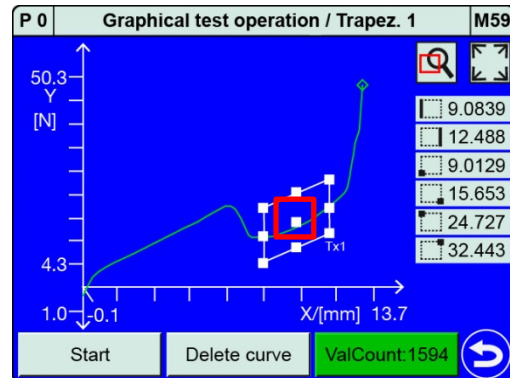

- Place your finger on one of the corners and drag it across the touchscreen to change the limits.

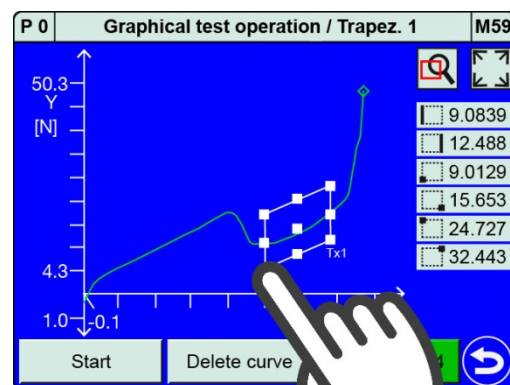

- Tap  to close the setup.

Configuring a trapezoid - AutoSize

You can use **[AutoSize]** to fit the Trapezoid size initially to the current graph scale. You can then choose to adjust the size by changing the limits. You can adjust the limits either as described in "Configuring a trapezoid – Limits" in section 6.3.5.4 "Graphical Test Operation – Configuring a trapezoid" on page 145 or in the "Trapezoid window configuration" menu (M13) as described in section 6.3.3.2 "Trapezoid" on page 120.

Note: If you are configuring a graphical evaluation element for a measurement curve with a forward and return segment, make sure you assign the correct curve segment to the element ("Forward", "Return" or "Complete curve"). To specify the curve segment, open the "Trapezoid window configuration" menu (M13) using the **[Numerical]** button.

DIGIFORCE[®] model 9311



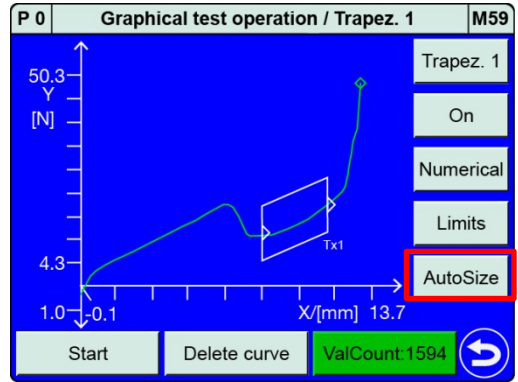

This is how it works

- 1 In "Graphical test operation / Trapez. 1 or 2" tap **[AutoSize]** to adjust the size of the trapezoid.

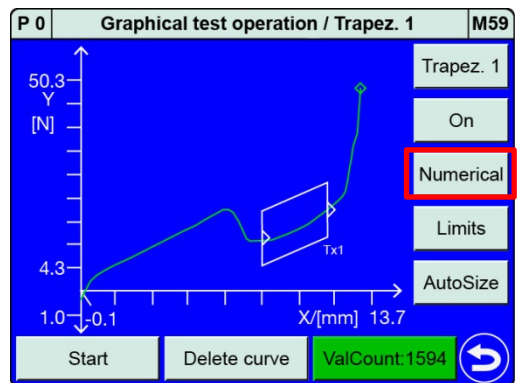

- 2 Tap **[Numerical]** to open the "Trapezoid window configuration" menu and then set the correct "Curve segment". You have a choice of "Forward", "Return" or "Complete curve".



- 3 Tap  to return to the "Graphical test operation / Trapez. 1 or 2" menu.

6.3.5.5 Graphical Test Operation – Configuring a threshold

In the "Graphical test operation" menu (M59) you can enable the "Threshold" graphical evaluation element and place it, move it and change its size directly in the measurement curve graph. To access the full set of parameters, you can switch to the "Threshold configuration" menu (M14); for details, please see section 6.3.3.3 "Threshold" on page 124.

Note: When a "Threshold" graphical evaluation element is activated for the first time, it has the following default settings:

Type	X threshold (vertical)
Crossing	From left
Curve segment	Forward
X	0.0
Ymin	0.0
Ymax	1.0

You can use **[AutoSize]** to fit the Threshold size and position initially to the current graph scale. You can then adjust the size by changing the limits.

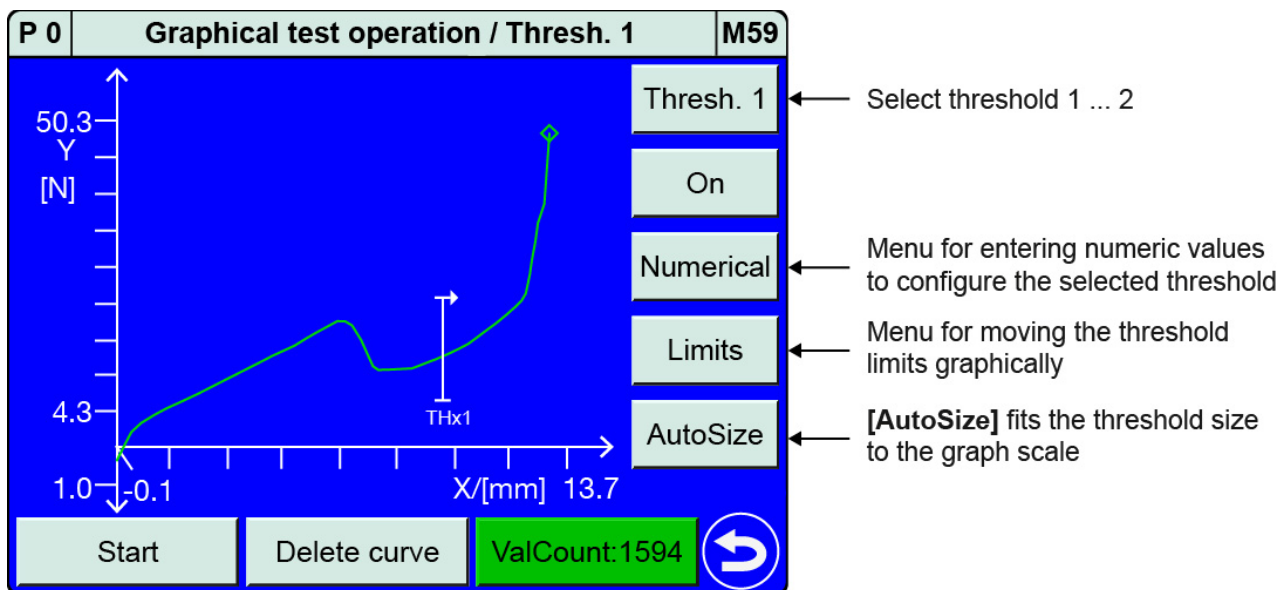

Diagram 66: Graphical Test Operation – Threshold AutoSize

DIGIFORCE® model 9311



This is how it works

- 1 In measurement mode, tap anywhere on the touchscreen. The icon appears in the bottom-right corner.
- 2 Tap to open the "Configuration Main Menu".
- 3 Tap the "Program Setup" icon.
- 4 Tap the "Graph. TestOp." icon.
- 5 Tap [Evaluation].

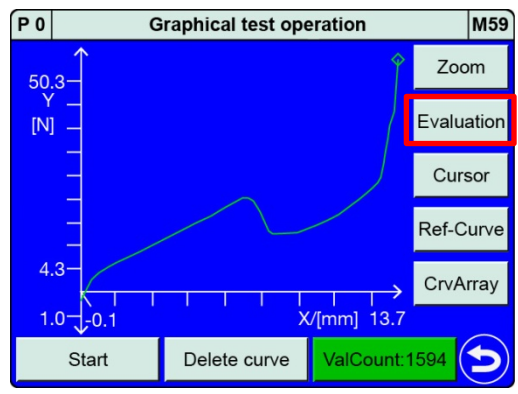

- 6 Tap [Thresh.] and select your required threshold number (1 or 2). Tap [Off] to activate the threshold.

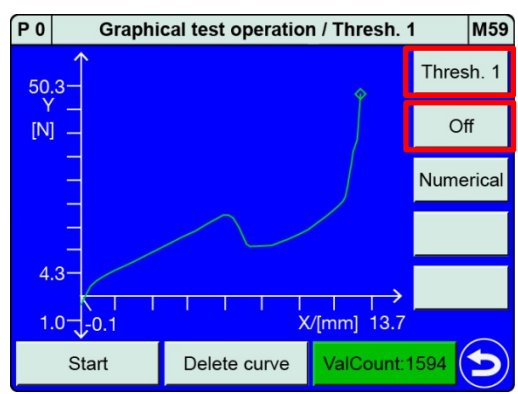

- 7 The threshold is placed on the measurement curve.

Note: The defaults settings are:
 Type = X threshold (vertical),
 Crossing = from left,
 Curve segment = Forward,
 X = 0.0, Ymin = 0.0 and
 Ymax = 1.0.

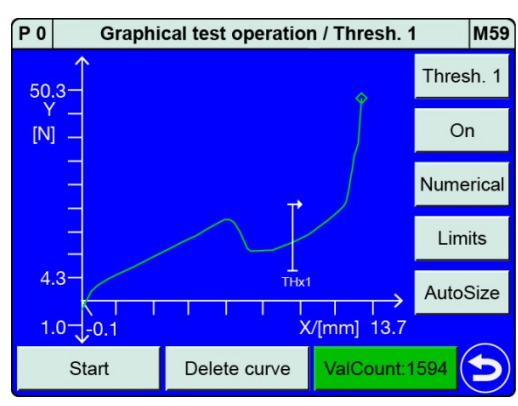

Configuring a threshold - Numerical

Tap **[Numerical]** to open the "Threshold configuration" menu (M14) for the previously selected threshold. For details of the possible settings, please refer to section 6.3.3.3 "Threshold" on page 124.

Note: Select here, amongst other settings, whether you want to use an "X threshold" or "Y threshold" as the threshold type.

Configuring a threshold - Limits

If you tap **[Limits]**, you can change the position and size of the selected threshold directly on the touchscreen using your finger.

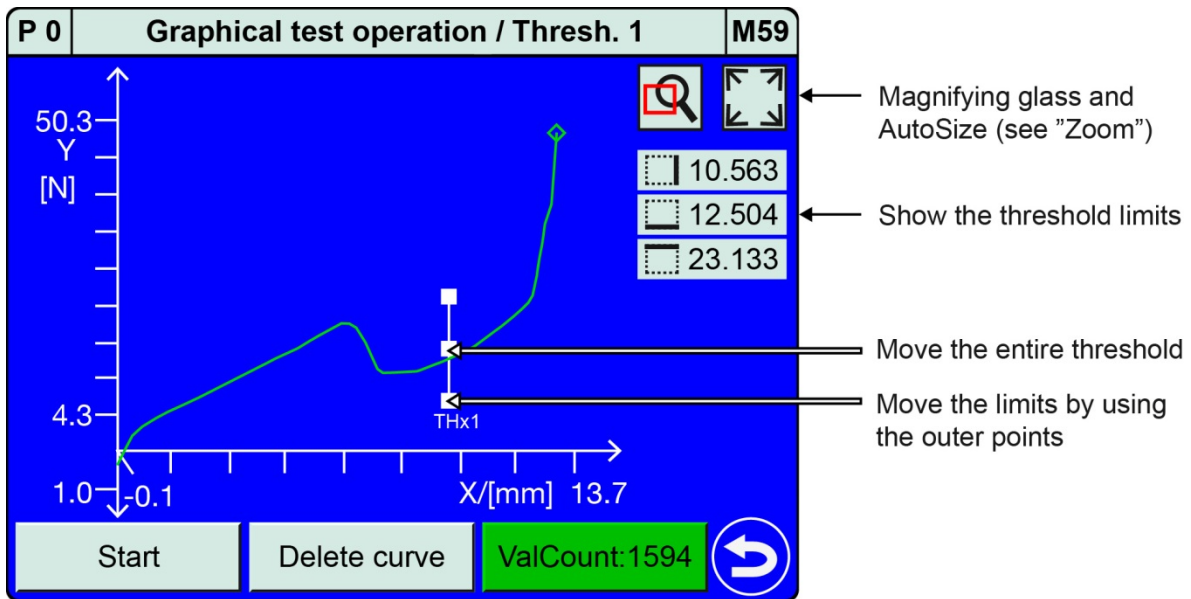
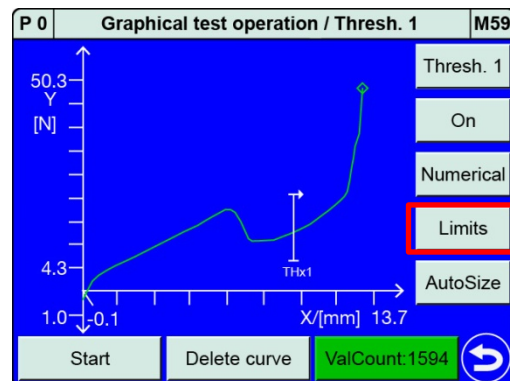

Diagram 67: Graphical Test Operation – Threshold Limits



This is how it works

- 1 Tap **[Limits]** in the "Graphical test operation / Thresh. 1 or 2" menu.



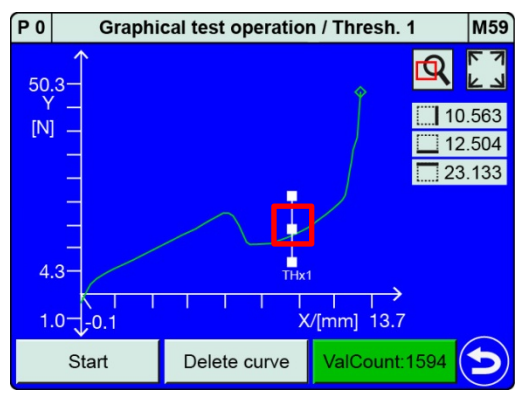

DIGIFORCE® model 9311

2 Place your finger in the centre of the threshold and drag it in the direction in which you want to move the threshold.

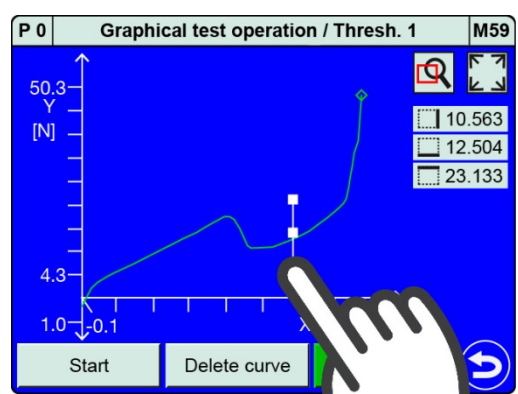

3 Place your finger on one of the corners and drag it across the touchscreen to change the limits.



4 Tap  to close the setup.

Configuring a threshold - AutoSize

You can use **[AutoSize]** to fit the Threshold size and position initially to the current graph scale. You can then choose to adjust the size by changing the limits. You can adjust the limits either as described in "Configuring a threshold – Limits" in section 6.3.5.5 "Graphical Test Operation – Configuring a threshold" on page 150 or in the "Threshold configuration" menu (M14) as described in section 6.3.3.3 "Threshold" on page 124.

Note: If you are configuring a graphical evaluation element for a measurement curve with a forward and return segment, make sure you assign the correct curve segment to the element ("Forward", "Return" or "Complete curve"). To specify the curve segment, open the "Threshold configuration" menu (M14) using the **[Numerical]** button.



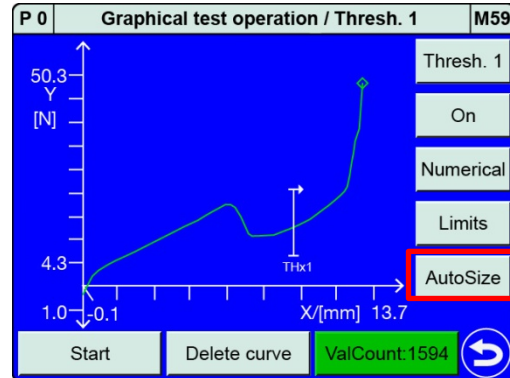

This is how it works

- 1 Tap **[AutoSize]** in the "Graphical test operation / Thresh. 1 or 2" menu to adjust the size of the threshold.

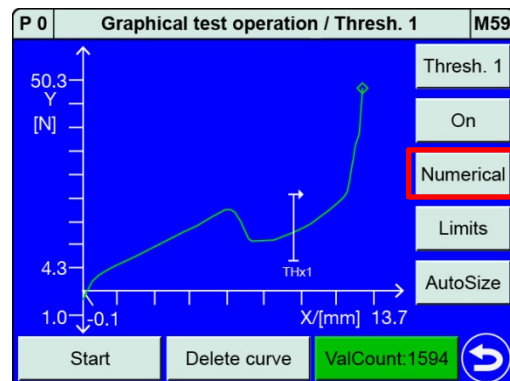

- 2 Tap **[Numerical]** to open the "Threshold configuration" menu and then set the correct "Curve segment". You have a choice of "Forward", "Return" or "Complete curve".



- 3 Tap  to return to the "Graphical test operation / Thresh. 1 or 2" menu.

6.3.5.6 Graphical Test Operation – Generating an envelope

In the "Graphical test operation" menu (M59) you can generate the "Envelope" graphical evaluation element. To do this, you need to run at least one measurement. When generating the envelope, all the measurements available in the curve memory (up to 10 measurement curves) are used as the basis for the calculation.

Note: In the "Graphical test operation" menu (M59) you can use **[CrvArray]** to display the set of curves for the available measurements. You can then delete from the memory any individual measurement curves that you do not want to be used for calculating the envelope. When starting the envelope generation process it makes sense to delete old measurement curves.

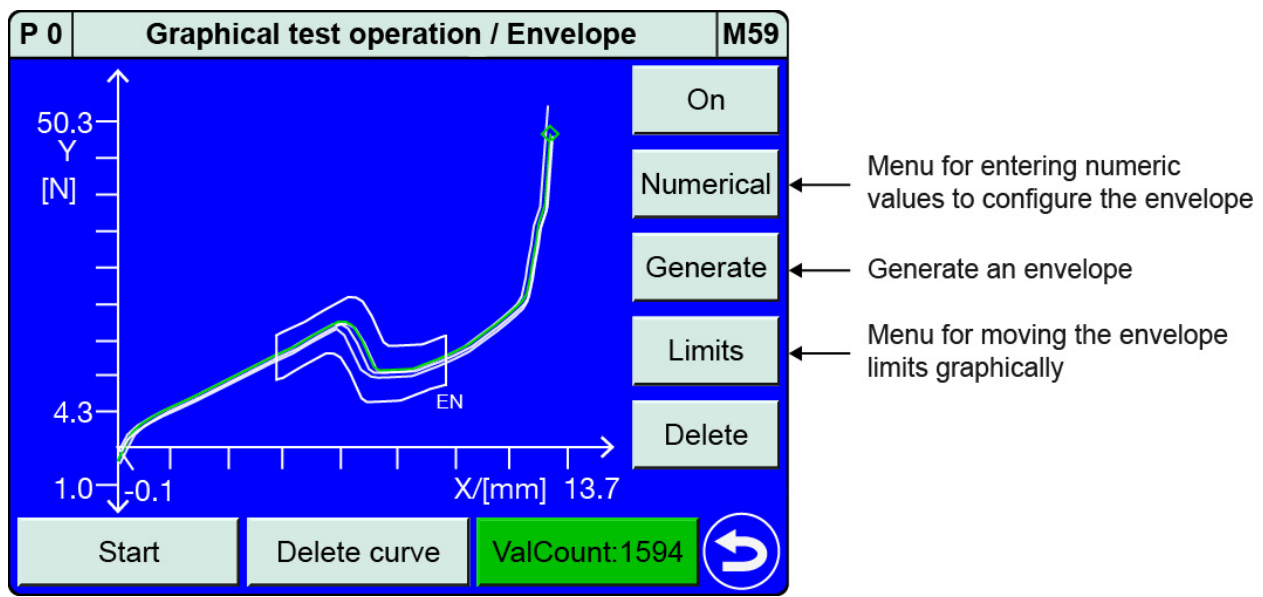
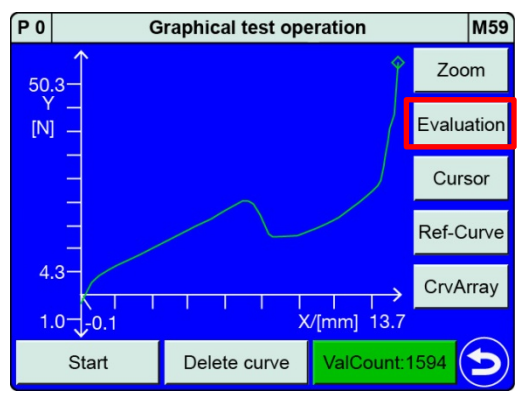

Diagram 68: Graphical Test Operation – Envelope



This is how it works

- 1 In measurement mode, tap anywhere on the touchscreen. The icon appears in the bottom-right corner.
- 2 Tap to open the "Configuration Main Menu".
- 3 Tap the "Program Setup" icon.
- 4 Tap the "Graph. TestOp." icon.
- 5 Tap **[Evaluation]**.



- 6 Tap **[Envelope]**. Tap **[Off]** to activate the envelope.

Note: You must run at least one measurement before you can generate the envelope. All the measurement curves stored in the curve array memory are used as the basis for calculating the envelope.

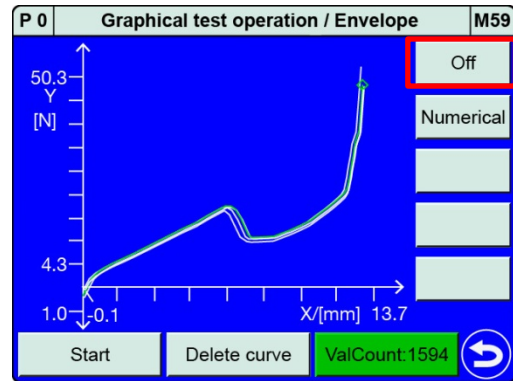

- 7 Tap **[Generate]**. Select the Entry side. You have a choice of "Left", "Right", "Bottom" or "Top".

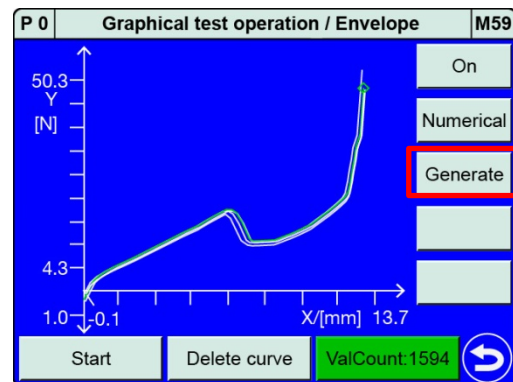

- 8 Select the curve segment. You have a choice of "Forward" or "Return". The envelope is then generated automatically.

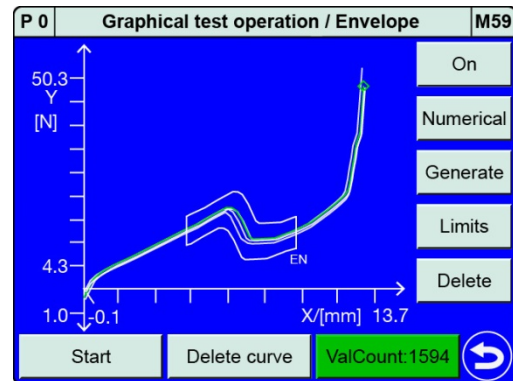

DIGIFORCE® model 9311

Note: The DIGIFORCE® 9311 can only generate an "envelope" if the entire curve segment (forward or return) runs in a continuous direction i.e. for a left or right entry, only one Y-value must be associated with each X-coordinate, or for a bottom or top entry, only one X-value must be associated with each Y-coordinate. If this is not the case, the instrument displays the error message "RefCurve not continuous"

Configuring an envelope - Numerical

Tap [Numerical] to open the "Envelope X[] Y[]" menu (M11) for the envelope. For details of the possible settings, please refer to section 6.3.3.4 "Envelopes" on page 128.

Configuring an envelope - Limits

If you tap [Limits], you can change the position and size of the selected envelope directly on the touchscreen using your finger.

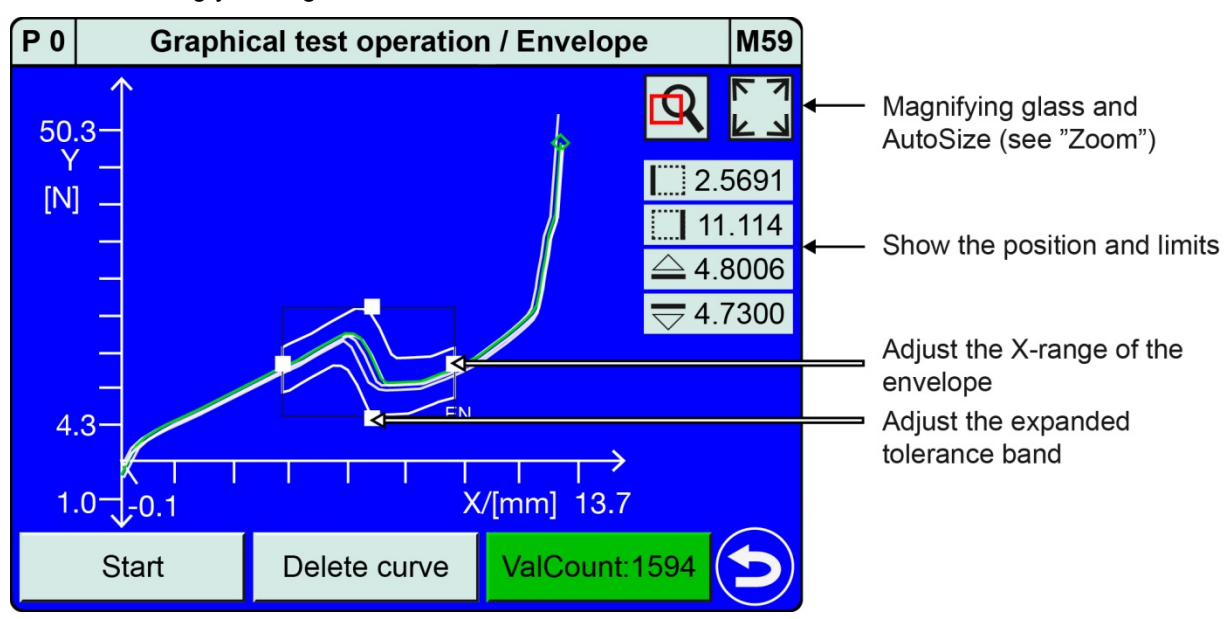

Diagram 69: Graphical Test Operation – Envelope Limits

Note: Since there is always some degree of spread in the measurement curves, it is not recommended to leave the start and end of the envelope at the maximum possible trained values. Instead, reduce the area to the essential region. It is also advisable to adjust the expanded tolerance band.



This is how it works

- 1 Tap **[Limits]** in the "Graphical test operation / Envelope" menu.

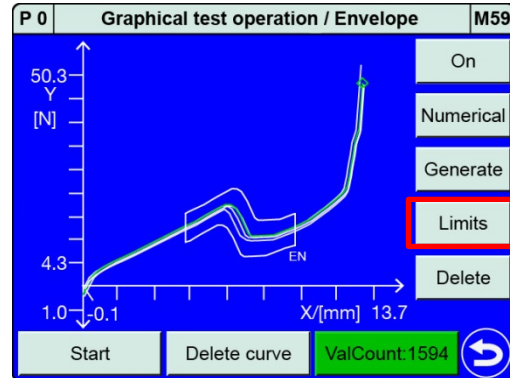

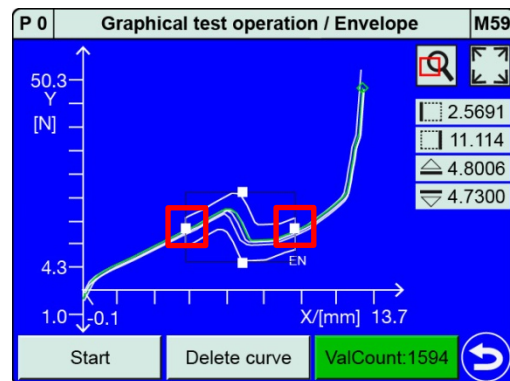

- 2 Place your finger on the left-hand or right-hand point and drag it in the appropriate direction to enlarge or reduce the X-range of the envelope.

Note: After the envelope is generated, the entry/exit sides lie at the maximum possible values, i.e. the maximum possible X-range is set.

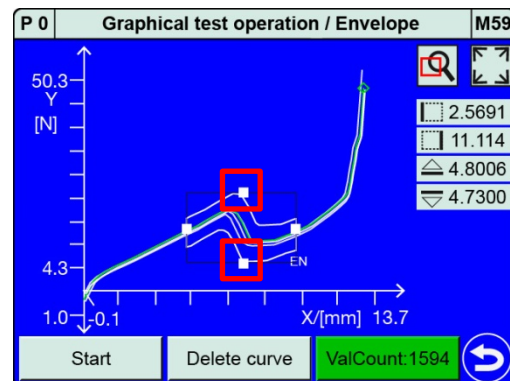

- 3 Place your finger on the top or bottom point and drag it up or down to enlarge or reduce the tolerance band of the envelope.



- 4 Tap  to close the setup.

Note: The DIGIFORCE® 9311 can only generate an "envelope" if the entire curve segment (forward or return) runs in a continuous direction i.e. for a left or right entry, only one Y-value must be associated with each X-coordinate, or for a bottom or top entry, only one X-value must be associated with each Y-coordinate. If this is not the case, the instrument displays the error message "RefCurve not continuous"

6.3.5.7 Graphical test operation – Cursor

You can use the **[Cursor]** in the "Graphical test operation / Cursor" menu (M59) to select any measurement-value pair and read off the associated X/Y values.

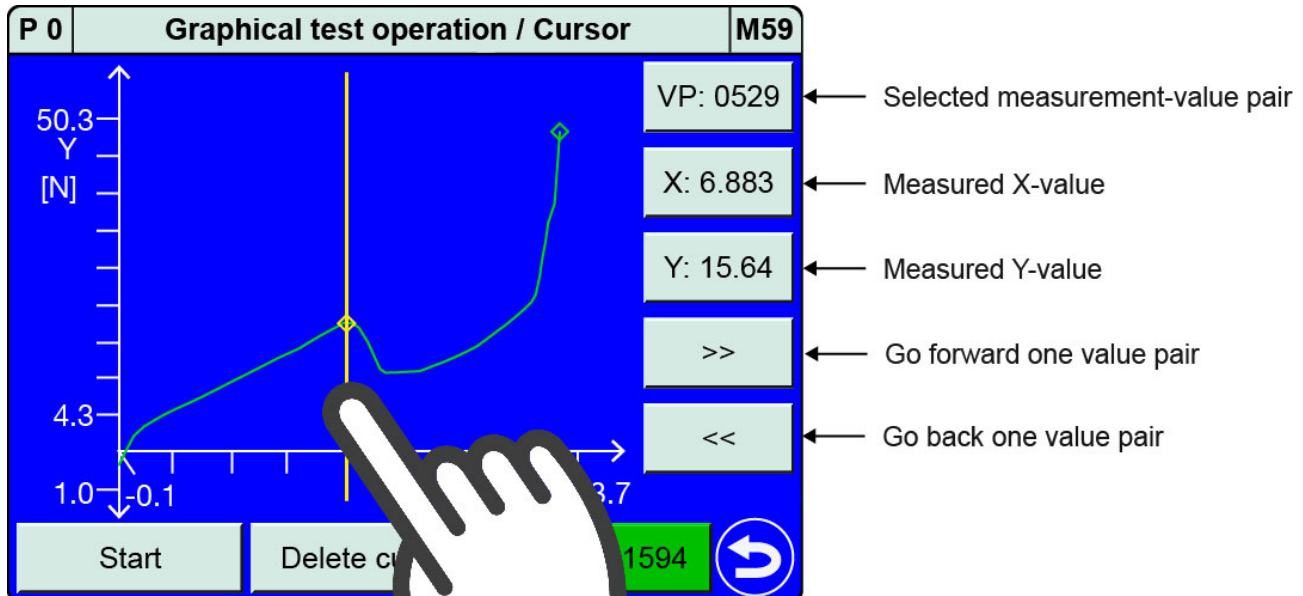

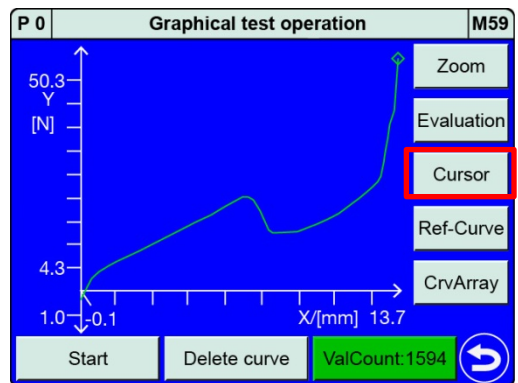

Diagram 70: Graphical test operation – Cursor





This is how it works



- 1 In measurement mode, tap anywhere on the touchscreen. The  icon appears in the bottom-right corner.
- 2 Tap  to open the "Configuration Main Menu".
- 3 Tap the "Program Setup" icon.
- 4 Tap the "Graph. TestOp." icon.
- 5 Tap **[Cursor]**. The cursor appears as a yellow line at the first measurement-value pair of the measurement curve.

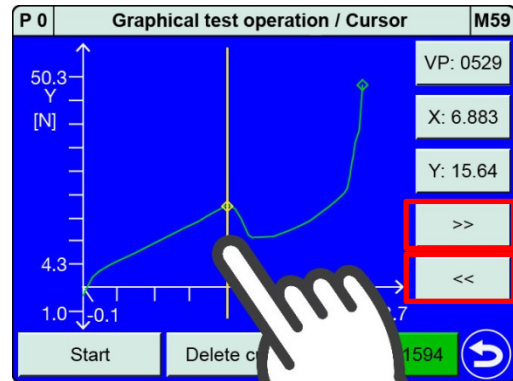

- 6 Place your finger on the yellow line and drag it to right or left across the touchscreen to select the measurement-value pair you require.
You can also tap [>>] or [<<] to move the cursor left or right.



- 7 Tap  to return to the "Graphical test operation" menu.



Note: The "Cursor" can also be used to locate the sources of NOK evaluations. To do this, zoom into the *suspected* area and enable the "Cursor". Then use [<<] and [>>] to run along the measurement points of the measurement curve. By swiping  or , you can adjust the currently displayed section of the curve, provided the "Zoom" is not set to "FixScale".

6.3.5.8 Graphical test operation – Reference curve

You can use **[Ref-Curve]** in the "Graphical test operation" menu (M59) to save the current measurement curve as the reference curve and display this curve in the graph in measurement mode. The reference curve is shown in violet and can be used by an operator to identify any differences between the actual curve and ideal curve. A fewer number of measurement value pairs are saved for the reference curve.



This is how it works

- 1 In measurement mode, tap anywhere on the touchscreen. The  icon appears in the bottom-right corner.
- 2 Tap  to open the "Configuration Main Menu".
- 3 Tap the "Program Setup" icon.
- 4 Tap the "Graph. TestOp." icon.
- 5 Tap **[Ref-Curve]**.

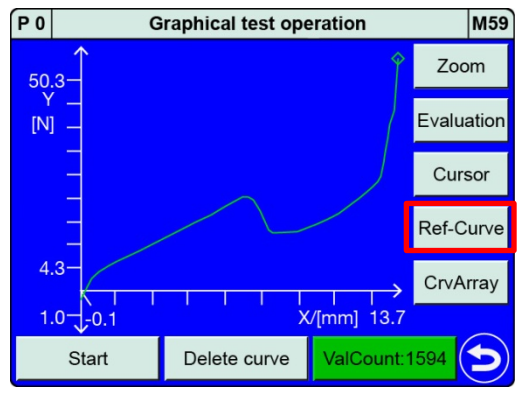

- 6 If the reference curve is **[Off]**, tap **[Off]** to enable the function. Tap **[Save]** to save the displayed measurement curve as the reference curve.
Note: This will overwrite any reference curve that you may have saved previously.

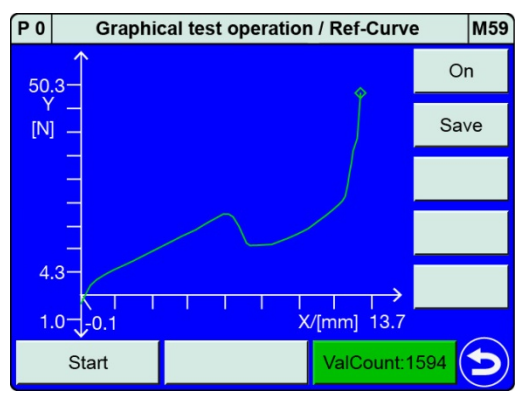

- 7 A window opens displaying the message "Ref-Curve saved!". Tap **[ENTER]** to confirm the save. The reference curve is now shown in violet.

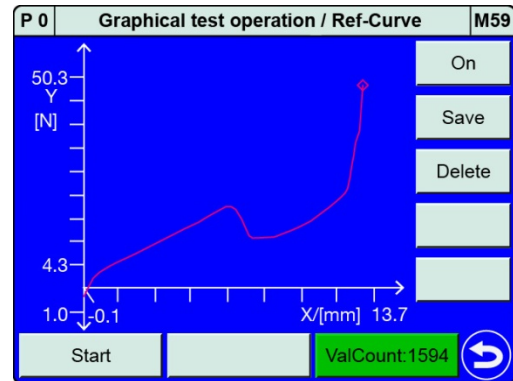



- 8 Tap  to return to the "Graphical test operation" menu.

6.3.5.9 Graphical Test Operation – Displaying a curve array

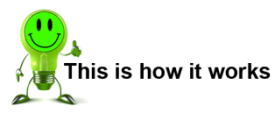
You can use **[CrvArray]** in the "Graphical test operation" menu (M59) to display simultaneously the 10 most recent measurement curves as a curve array. This lets you easily and conveniently identify any trend in the measurements directly from the DIGIFORCE® 9311. In addition, you can select and examine individual measurement curves in the curve array. Before generating an envelope, you can also use this tool to delete any measurement curves that you do not want used as a basis for calculating the envelope.



- 1 In measurement mode, tap anywhere on the touchscreen. The  icon appears in the bottom-right corner.
- 2 Tap  to open the "Configuration Main Menu".
- 3 Tap the "Program Setup" icon.
- 4 Tap the "Graph. TestOp." icon.
- 5 Tap **[CrvArray]**.

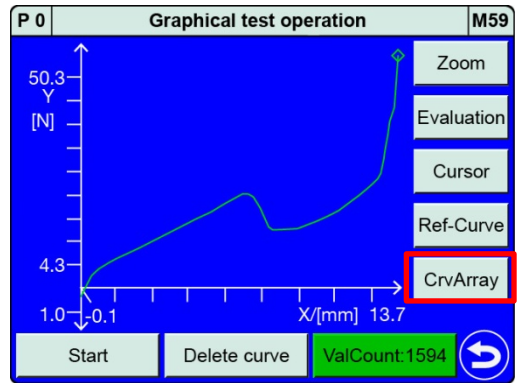

- 6 Tap **[Off]** to display the curve array.

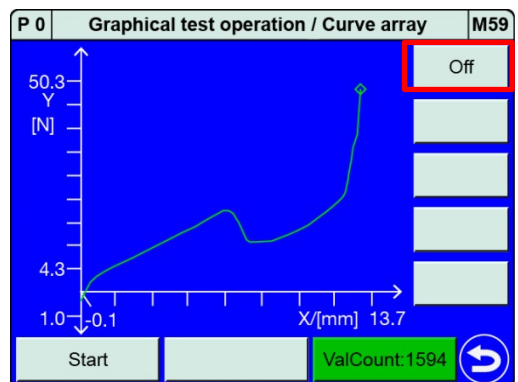

- 7 The selected measurement curve is shown in violet. You can use [>>] or [<<] to select a different measurement curve, or **[Delete]** to remove a curve from the curve array.

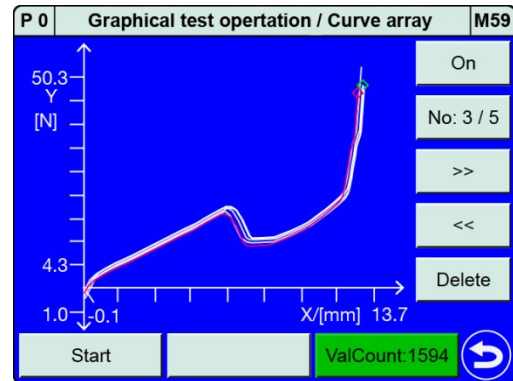

- 8 Tap  to return to the "Graphical test operation" menu.

6.3.6 Numerical test operation

In the "Numerical test operation" menu (M58) you can retrieve the live sensor values from the active measurement channels X and Y and retrieve the status of the PLC control signals (inputs and outputs). You can also tare each measurement channel separately (the tare function is not available for the optional piezoelectric input).

You can stimulate the PLC outputs manually in order to test the cable to the connected PLC. The PLC signals can also be viewed/set under Fieldbus communication.

Note: If the PLC sets the "IN_AUTO" control input, the "Numerical test operation" menu (M58) will close automatically and the DIGIFORCE® 9311 will switch to measurement mode.

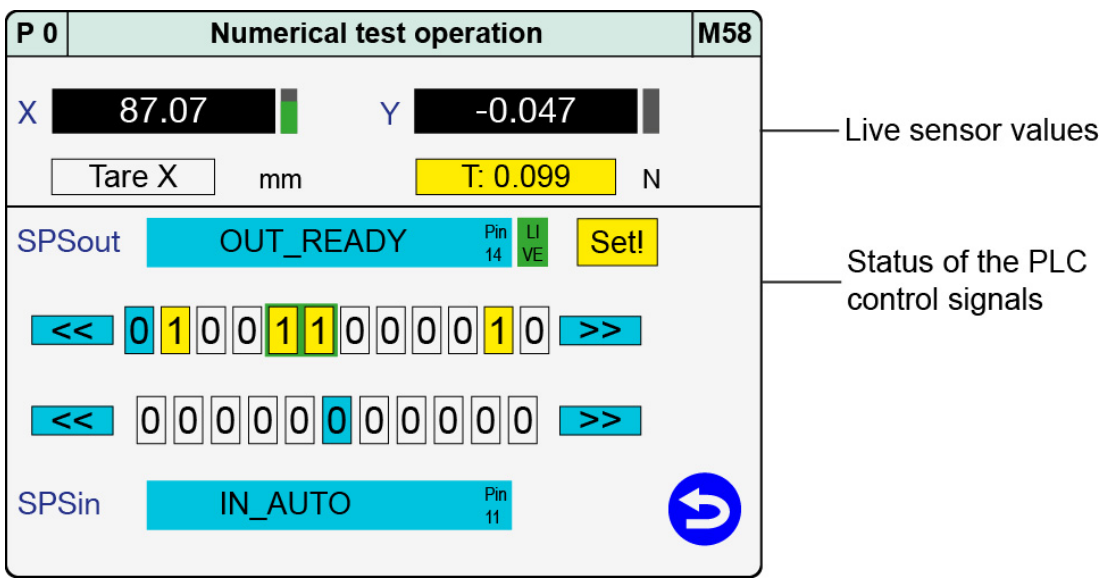





Diagram 71: Numerical test operation

 **This is how it works**

- 1 In measurement mode, tap anywhere on the touchscreen. The  icon appears in the bottom-right corner.
- 2 Tap  to open the "Configuration Main Menu".
- 3 Tap the "Program Setup" icon.
- 4 Tap the "Num. TestOp." icon.
- 5 Tap  to return to the "Program Setup" menu.

6.3.6.1 Numerical Test Operation - Live sensor values

In the "Numerical test operation" menu (M58), you can view the live sensor values. For analog sensor signals such as strain gage, potentiometer or standard signals, you can set the resolution for the reading to either a four-digit or five-digit display. The resolution can be changed by selecting "Normal resolution" (four-digit display with dynamic decimal point) or "High resolution" (five-digit display with dynamic decimal point).

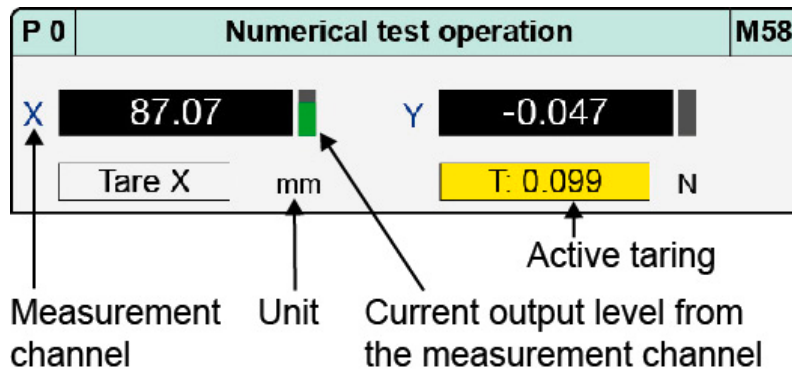

Diagram 72: Live sensor values

Switching between "Normal resolution" and "High resolution"



Tapping in the menu header area opens the "Select resolution" menu, where you can switch between "normal" and "high".

Note: The display always reverts to "Normal resolution" when you exit the "Numerical test operation" menu (M58).

Note: The reading is displayed as a floating-point value. The display resolution does not depend on the measurement range. This can give a false impression of the signal quality.



This is how it works

- 1 In measurement mode, tap anywhere on the touchscreen. The  icon appears in the bottom-right corner.
- 2 Tap  to open the "Configuration Main Menu".
- 3 Tap the "Program Setup" icon.
- 4 Tap the "Num. TestOp." icon.

DIGIFORCE[®] model 9311

- 5 Tap anywhere in the header of the "Numerical test operation" menu.

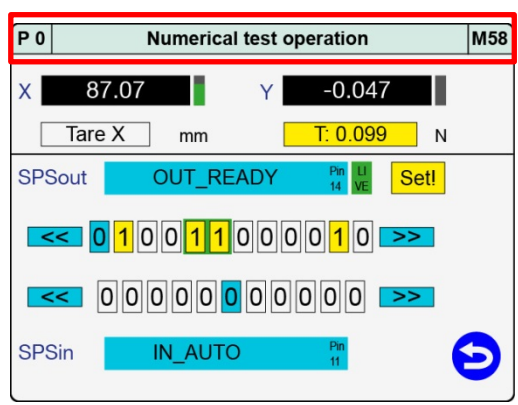

- 6 Tap the resolution you require and confirm your selection with [ENTER]. You have a choice of "normal" or "high".

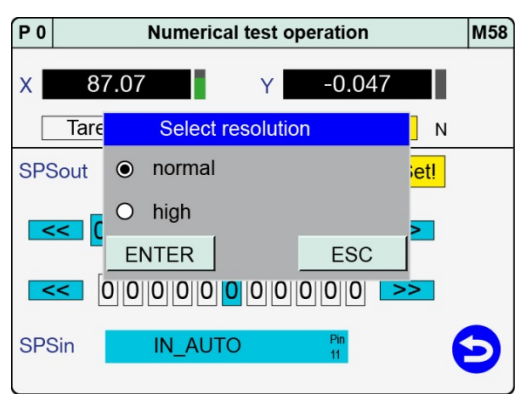

- 7 Tap  to return to the "Program Setup" menu.

6.3.6.2 Numerical Test Operation – Tare

You can use the **[Tare X]** and **[Tare Y]** buttons to tare the live sensor values. Running the tare function will zero the live sensor value or set it to a configurable default value ("Standard value for tare") (for details see the relevant subsection for the individual sensors in section 6.3.1 "Channel settings" on page 71). You can also use the PLC control signals "IN_TARE_X", "IN_TARE_Y" and "IN_TARE_X+Y" to run this function in measurement mode or in the "Graphical test operation" menu (M59).

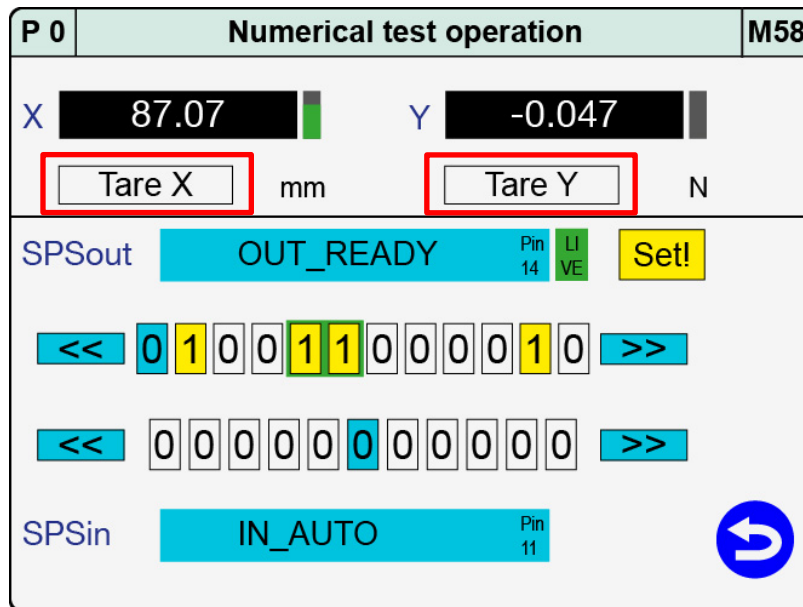

Diagram 73: Numerical Test Operation – Tare

Note: Tapping **[Tare X]** or **[Tare Y]** switches off the tare function again. The tare function will be performed, however, whenever requested by the PLC signals.

6.3.6.3 Numerical Test Operation - PLC signals

You can retrieve the live states of the PLC inputs and outputs in the "Numerical test operation" menu (M58), and also set/reset the PLC outputs. You can also use this function when the instrument is controlled via the Fieldbus option (e.g. PROFIBUS or PROFINET). In this case, the corresponding signals are displayed and set/reset.

Note: Note that on activating the "IN_AUTO" control input, the "Numerical test operation" menu (M58) will close automatically and the DIGIFORCE® 9311 will switch to measurement mode.

This field (highlighted in light blue) indicates the selected PLC output - pin 14 "OUT_READY" (0/Low) in this case

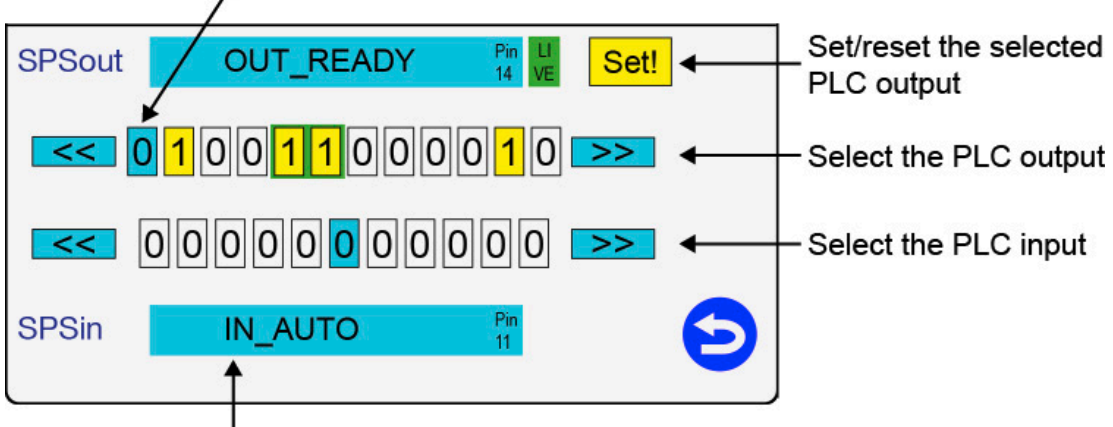

This field (highlighted in light blue) indicates the selected PLC input - pin 11 „IN_AUTO“ (0/Low) in this case

Diagram 74: Numerical Test Operation - PLC signals



This is how it works

- 1 In measurement mode, tap anywhere on the touchscreen. The icon appears in the bottom-right corner.
- 2 Tap to open the "Configuration Main Menu".
- 3 Tap the "Program Setup" icon.
- 4 Tap the "Num. TestOp." icon.
- 5 Tap [] or [] to select the PLC output you require.

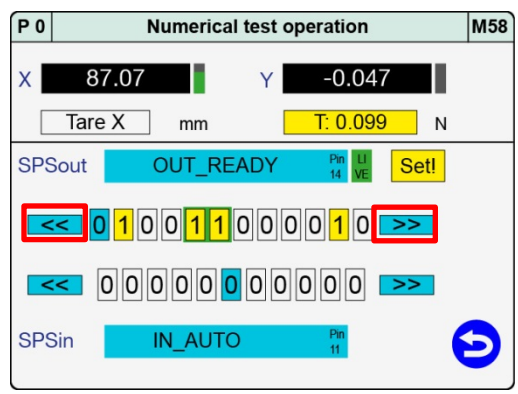

- 6 Tap **[Set!]** or **[Reset!]** to change the state of the PLC output.

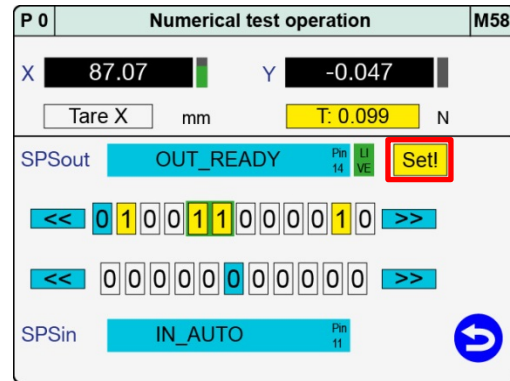

- 7 Tap **[<<]** or **[>>]** to select the PLC input you require.

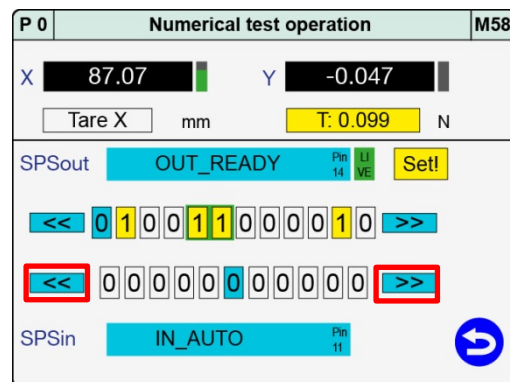

- 8 Tap to return to the "Program Setup" menu.

Online switching points

If a measurement exceeds the set limit level then the associated online switching point (S1 to S6) responds in the "Numerical test operation" menu (M58), provided the signal is highlighted with a green background (note that with the default configuration only signals S1 and S2 are available). You can remove the green highlighting by tapping the row containing the PLC outputs. You can then set/reset the signals manually (for details of how to configure the online switching signals, please see section 6.3.4 "Online switching points" on page 132).

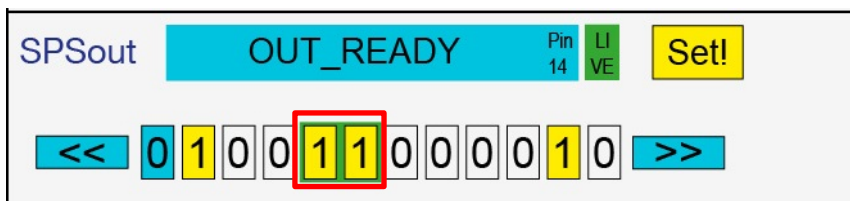

Diagram 75: Numerical Test Operation - Online switching points

You can monitor the behaviour of the switching signals S1 to S6 in this menu (for further details, please see section 6.3.4 "Online switching points" on page 132). The signals must be highlighted with the "Live" green background, however, to monitor the live states.

Exception: an online switching point for measurement channel X with trigger reference is enabled solely during a measurement in measurement mode or in the "Graphical test operation" menu (M59).

You can assign switching signals S3 to S6 to any PLC output eligible for custom signal assignments (please see section 6.1.2 "PLC outputs" on page 46).



DIGIFORCE® model 9311

6.3.7 Sensor test

The "Sensor test" function can be used for cyclical testing of the active measurement channels. In the test, the DIGIFORCE® 9311 compares the live measurements with stored reference values. The DIGIFORCE® 9311 evaluates the result as "sensor test OK/NOK" depending on whether or not the measured value lies within the defined tolerance; for details please see section 3.8 "Sensor test" on page 21. The "Sensor test" can be launched using the "IN_STEST" control signal or a configurable function key.



This is how it works

- 1 In measurement mode, tap anywhere on the touchscreen. The  icon appears in the bottom-right corner.
- 2 Tap  to open the "Configuration Main Menu".
- 3 Tap the "Program Setup" icon.
- 4 Tap the "Sensor Test" icon.
- 5 Enable the "Sensor test active" checkbox under "Channel X [mm]".
- 6 Measure the "Measured Setpoint" by tapping **[0.00000]**.

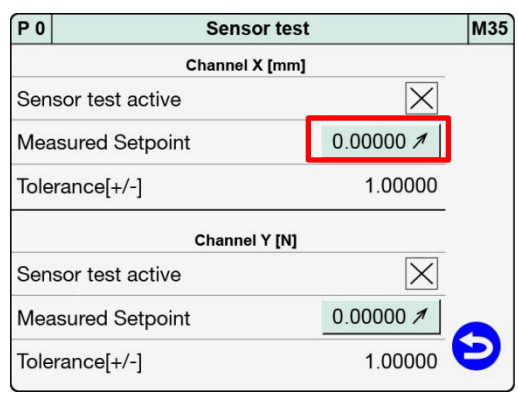

- 7 Tap "Tolerance[+/-]" to enter the allowed tolerance.
- 8 Repeat steps 5 to 7 for "Channel Y [N]".
- 9 Tap  to return to the "Program Setup" menu.

Parameters for channels X and Y in the "Sensor test" menu (M35)

Sensor test	On / Off	Enable/disable
Measured setpoint	<value>	Reference value measured for the sensor test. This value is used as the comparison value when running the sensor test. If the value measured during the sensor test lies within the permitted tolerance, the control signal "OUT_OK_STEST" is set to 1 (sensor test OK). If the value lies outside the permitted tolerance, then "OUT_OK_STEST" = 0 (sensor test NOK).
Tolerance [+/-]	<value input>	Set here the permitted +/- tolerance for the OK/NOK decision of the sensor test.

Running the sensor test

You can initiate the sensor test via the PLC I/O control interface or the Fieldbus interface using the "IN_STEST" signal (please see section 8.7 "External actuation of a sensor test" on page 210). You also have the option to assign the "sensor test" function to one of the measurement mode function keys (see section 6.1.1 "Function key definition" on page 44).

Note: Do not run the cyclical "tare" function in conjunction with "sensor test" at the same reference value e.g. at the reference position on a machine. If you were to do this, the tare action would prevent reliable identification of any potential sensor fault or sensor drift.

6.3.8 User-defined values

The DIGIFORCE[®] 9311 can display a range of results in measurement mode, which you can also output via an interface, for instance the PLC interface (please see section 7.6 "M5 User defined values" on page 192). These measurement results include, for instance, entry and exit values for the graphical evaluation elements. Before the DIGIFORCE[®] 9311 can display any of these values, they need to be enabled in the "User-defined values" menu (M45). You can enable up to 20 values.

The following values are available for selection:

General curve data

Start X	First measured value of the measurement curve – X-coordinate
Start Y	First measured value of the measurement curve – Y-coordinate
End X	Last measured value of the measurement curve – X-coordinate
End Y	Last measured value of the measurement curve – Y-coordinate
AbsMaxX (X)	Absolute maximum of entire measurement curve for X-channel – X-coordinate
AbsMaxX (Y)	Absolute maximum of entire measurement curve for X-channel – Y-coordinate
AbsMinX (X)	Absolute minimum of measurement curve for X-channel – X-coordinate
AbsMinX (Y)	Absolute minimum of measurement curve for X-channel – Y-coordinate
AbsMaxY (X)	Absolute maximum of measurement curve for Y-channel – X-coordinate
AbsMaxY (Y)	Absolute maximum of measurement curve for Y-channel – Y-coordinate
AbsMinY (X)	Absolute minimum of measurement curve for Y-channel – X-coordinate
AbsMinY (Y)	Absolute minimum of measurement curve for Y-channel – Y-coordinate
ReturnP.X	Return point of measurement curve – X-coordinate
ReturnP.Y	Return point of measurement curve – Y-coordinate

Window (1 to 3)

$W_{1/2/3}$ Entry X	Window entry value – X-coordinate
$W_{1/2/3}$ Entry Y	Window entry value – Y-coordinate
$W_{1/2/3}$ Exit X	Window exit value – X-coordinate
$W_{1/2/3}$ Exit Y	Window exit value – Y-coordinate
$W_{1/2/3}$ AbsMin X	Absolute minimum for Y-channel inside window – X-coordinate
$W_{1/2/3}$ AbsMin Y	Absolute minimum for Y-channel inside window – Y-coordinate
$W_{1/2/3}$ AbsMax X	Absolute maximum for Y-channel inside window – X-coordinate
$W_{1/2/3}$ AbsMax Y	Absolute maximum for Y-channel inside window – Y-coordinate
$W_{1/2/3}$ Pos Xmin	Window boundary, Xmin

$W_{1/2/3}$ Pos Xmax	Window boundary, Xmax
$W_{1/2/3}$ Pos Ymin	Window boundary, Ymin
$W_{1/2/3}$ Pos Ymax	Window boundary, Ymax

Trapezoid (1 or 2)

$TW_{1/2}$ Entry X	Trapezoid entry value – X-coordinate
$TW_{1/2}$ Entry Y	Trapezoid entry value – Y-coordinate
$TW_{1/2}$ Exit X	Trapezoid exit value – X-coordinate
$TW_{1/2}$ Exit Y	Trapezoid exit value – Y-coordinate
Trapezoid of type X	
$TW_{1/2}$ Pos Xmin	Trapezoid boundary (type X), Xmin
$TW_{1/2}$ Pos Xmax	Trapezoid boundary (type X), Xmax
$TW_{1/2}$ Pos YminLe	Trapezoid boundary (type X), YminLeft
$TW_{1/2}$ Pos YmaxLe	Trapezoid boundary (type X), YmaxLeft
$TW_{1/2}$ Pos YminRi	Trapezoid boundary (type X), YminRight
$TW_{1/2}$ Pos YmaxRi	Trapezoid boundary (type X), YmaxRight
Trapezoid of type Y	
$TW_{1/2}$ Pos Ymin	Trapezoid boundary (type Y), Ymin
$TW_{1/2}$ Pos Ymax	Trapezoid boundary (type Y), Ymax
$TW_{1/2}$ Pos YminBo	Trapezoid boundary (type Y), XminBottom
$TW_{1/2}$ Pos XmaxBo	Trapezoid boundary (type Y), XmaxBottom
$TW_{1/2}$ Pos XminTo	Trapezoid boundary (type Y), XminTop
$TW_{1/2}$ Pos XmaxTo	Trapezoid boundary (type Y), XmaxTop

Threshold (1 or 2)

$TH_{1/2}$ Pass X	Threshold crossing point (intersection) – X-coordinate
$TH_{1/2}$ Pass Y	Threshold crossing point (intersection) – Y-coordinate
Type X threshold	
$TH_{1/2}$ Pos Threshold	X-position of threshold
$TH_{1/2}$ Pos Ymin	Limit of threshold, Ymin
$TH_{1/2}$ Pos Ymax	Limit of threshold, Ymax

DIGIFORCE[®] model 9311

Type Y threshold	
TH _{1/2} Pos Threshold	Y-position of threshold
TH _{1/2} Pos Xmin	Limit of threshold, Xmin
TH _{1/2} Pos Xmax	Limit of threshold, Xmax



Envelope

EN Entry X	Envelope entry value – X-coordinate
EN Entry Y	Envelope entry value – Y-coordinate
EN Exit X	Envelope exit value – X-coordinate
EN Exit Y	Envelope exit value – Y-coordinate
EN Start X(Y)	Limits of envelope (X-value or Y-value depending on definition)
EN End X(Y)	Limits of envelope (X-value or Y-value depending on definition)

Activating values



This is how it works

- 1 In measurement mode, tap anywhere on the touchscreen. The  icon appears in the bottom-right corner.
- 2 Tap  to open the "Configuration Main Menu".
- 3 Tap the "Program Setup" icon.
- 4 Tap the "User-def. Val." icon.
- 5 Tap in the row that you want to assign a value.

P 0	User-defined values	M45
1		Off
2		Off
3		Off
4		Off
5		Off
6		Off
7		Off 

- 6 Under "Select group (x)", select the group you require and confirm your selection with [ENTER].
- 7 Under "Select value (x)", select the value you require and confirm your selection with [ENTER].

Note: For the DIGIFORCE[®] 9311 to be able to display the activated values, you need to enable the relevant view under measurement menus (please see section 6.1.5 "Measurement menus" on page 51).

- 8 Tap  to return to the "Program Setup" menu.



6.3.9 USB flash

In the "USB flash" menu (M80), you can enable/disable data logging on an external USB stick.

Note: If you wish to log the measurement data on the USB stick, you need to individually enable data logging for each measurement program.



This is how it works

- 1 Plug a USB stick into the rear USB port.
- 2 In measurement mode, tap anywhere on the touchscreen. The  icon appears in the bottom-right corner.
- 3 Tap  to open the "Configuration Main Menu".
- 4 Tap the "Program Setup" icon.
- 5 Tap the "USB flash" icon.
- 6 Enable the checkbox under "Logging".
- 7 Tap  to return to the "Program Setup" menu.

Note: Make sure you use a suitable USB stick. Please refer to the data sheet for further details. The latest version of the data sheet is available at <http://goo.gl/muUe7D>.

You can find further information in section 6.1.13 "USB flash" on page 57.

6.4 Copy programs

In the "Copy programs" menu (M38), you can copy measurement programs and sensor settings or initialize programs with a set of initial settings.

6.4.1 Copying a measurement program or sensor settings



If you want to re-use most of the settings in a measurement program, you can make a copy of the measurement program. You can then tweak these copies to suit the new requirements.

If you want to use just the sensor settings of a particular measurement program in other measurement programs, the DIGIFORCE® 9311 also lets you copy these settings into other measurement programs.

Note: Once you have overwritten an existing measurement program or its settings, the previous settings in this measurement program are lost.
 The **[Copy sensor setup]** function is not available if the channel settings in the "Basic setup" menu (M18) are set to "globally" (please see section 6.1.14 "Channel settings" on page 62).



This is how it works

- 1 To open the "Copy programs" menu from measurement mode, tap anywhere on the touchscreen. The  icon appears in the bottom-right corner.
- 2 Tap  to open the "Configuration Main Menu".
- 3 Tap the "Program Copy" icon.
- 4 Tap **[Source]** to select the source for the copy.

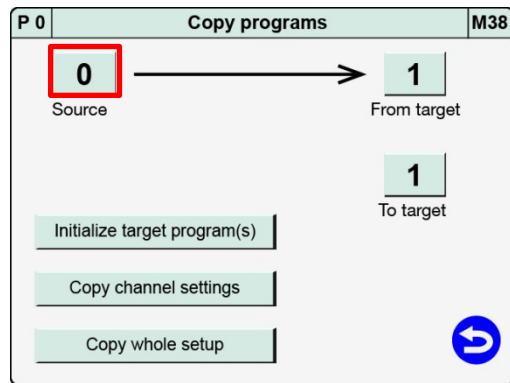

- 5 Tap **[From target]** to select the first destination program and then **[To target]** to select the last destination program to which you want to copy the data.

Note: The data is copied to all the measurement programs numbered between **[From target]** and **[To target]** inclusive. If you only want to overwrite one measurement program, select the same program number for **[From target]** and **[To target]**.

- 6 You have a choice of two different copy options:
[Copy channel settings] and **[Copy whole setup]**.
[Copy channel settings] overwrites just the sensor channel settings.
[Copy whole setup] overwrites all the settings in the measurement program.
Note: The **[Copy channel settings]** function is not available if the channel settings in the "Basic setup" menu (M18) are set to "globally" (please see section 6.1.14 "Channel settings" on page 62).

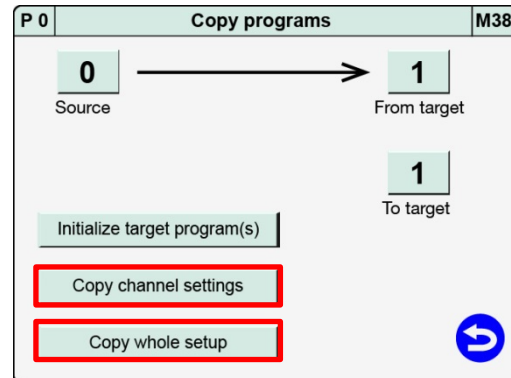

- 7 Tap the copy option you require. If you have selected **[Copy whole setup]**, the following message will be displayed: "Whole setup will be copied. All settings will be deleted! Tap **[ENTER]** to create the copy and overwrite all previous settings.
- 8 Tap  to return to the "Configuration Main Menu" menu.



6.4.2 Deleting a measurement program

If you want to discard all the settings for one or more measurement programs, you can do this using **[Initialize target program(s)]**. The DIGIFORCE[®] 9311 then resets the relevant measurement programs to the factory settings. This cannot be undone. The settings of the selected measurement programs are lost.

Note: As soon as you use **[Initialize target program(s)]** to delete an existing measurement program, all the settings in this program are lost.



This is how it works

- 1 To open the "Copy programs" menu from measurement mode, tap anywhere on the touchscreen. The  icon appears in the bottom-right corner.
- 2 Tap  to open the "Configuration Main Menu".
- 3 Tap the "Program Copy" icon.
- 4 Tap **[From target]** to select the first destination program and then **[To target]** to select the last destination program in which you want to initialize the data.

Note: The data is copied to all the measurement programs numbered between **[From target]** and **[To target]** inclusive. If you only want to overwrite one measurement program, select the same program number for **[From target]** and **[To target]**.

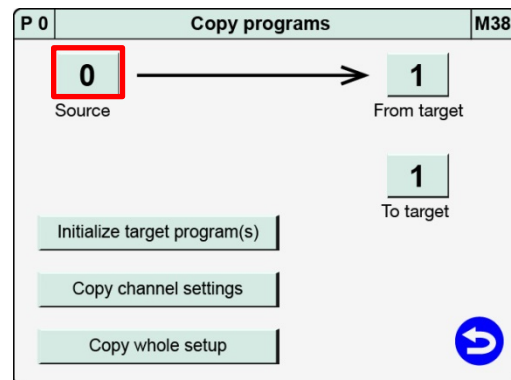

- 5 Tap **[Initialize target program(s)]**. The display shows the message "Target programs will be initialized. All settings will be deleted!"

Note: As soon as you use **[Initialize target program(s)]** to delete an existing measurement program, all the settings in this program are lost.

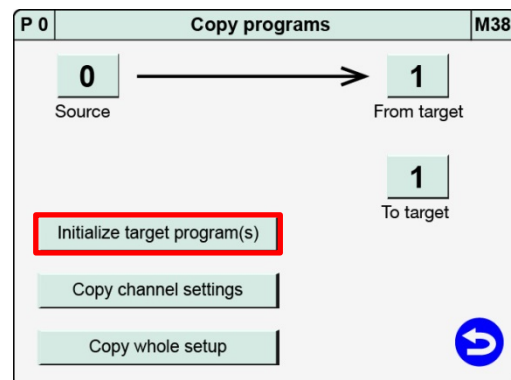

- 6 Tap **[ENTER]** to reset the destination programs permanently.
- 7 Tap  to return to the "Configuration Main Menu" menu.

6.5 Curve analysis (Viewer)

You can use the “Graphical Curve analysis” menu (M70) to look at the most recent 50 measurement curves either as individual curves or as a curve array. In addition, you have detailed numeric data available for each measurement, for instance individual results from the graphical evaluation elements and the associated measured values such as “Window” entry and exit coordinates.

Note: Be aware that the contents of the curve memory are lost when the DIGIFORCE® 9311 is switched off.

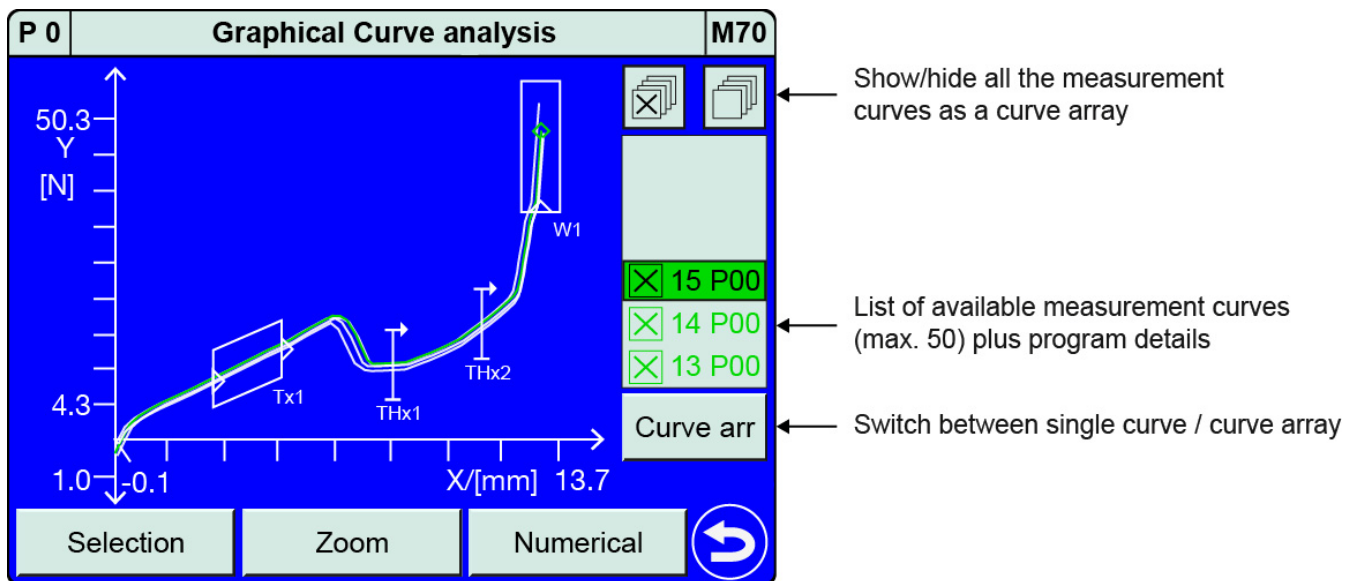

Diagram 76: Graphical Curve analysis

Note: If you are using a number of measurement programs to perform various measurements, which you are displaying as a curve array, the scale of the X/Y graph is set on the basis of the largest possible scale.

You can obtain the following program information from the list of available measurement curves:

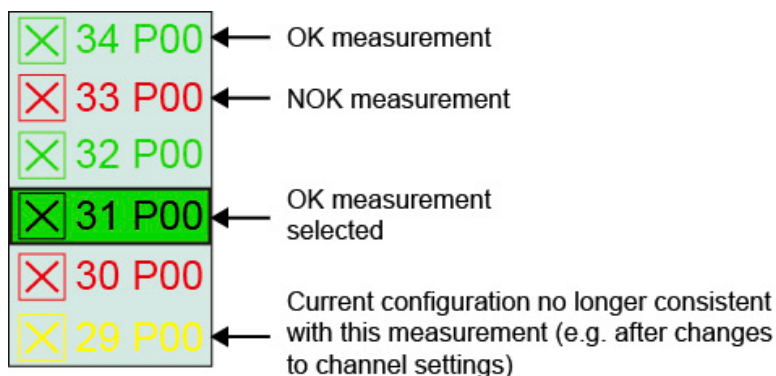



Diagram 77: Explanation of the list of available measurement curves

DIGIFORCE® model 9311



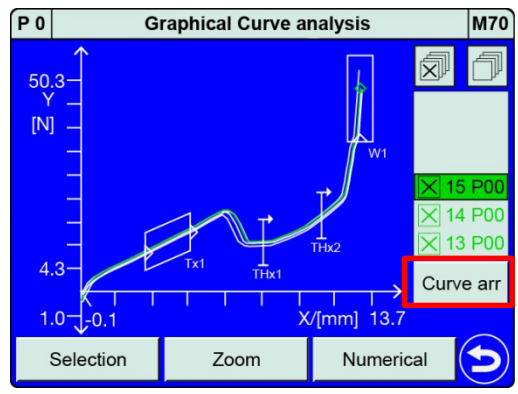

This is how it works

- 1 In measurement mode, tap anywhere on the touchscreen. The  icon appears in the bottom-right corner.
- 2 Tap  to open the "Configuration Main Menu".
- 3 Tap the "Curve Analysis" icon.
- 4 Tap **[Single]** or **[Curve arr]** to display a single measurement curve or a set of curves (curve array).

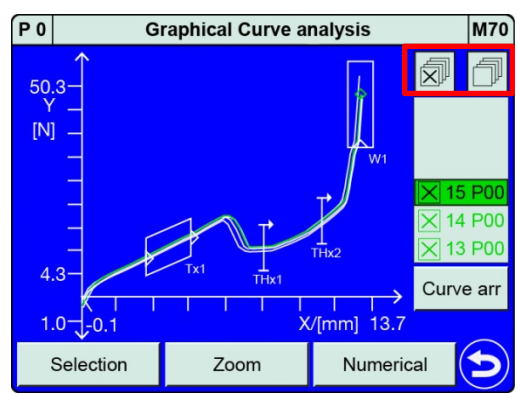

- 5 You can use these buttons to show/hide the curve array.



- 6 Swipe  the touchscreen to switch between the available measurement curves.

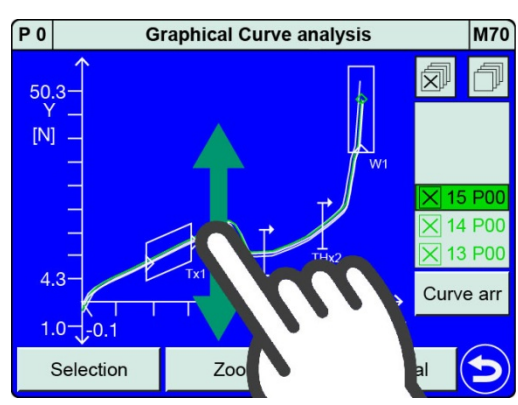



- 7 Tap  to return to the "Configuration Main Menu" menu.

6.5.1 Curve analysis - Selection

In the "Graphical Curve analysis" menu (M70) you can tap **[Selection]** to choose the individual measurement curves to be displayed as a curve array.



This is how it works

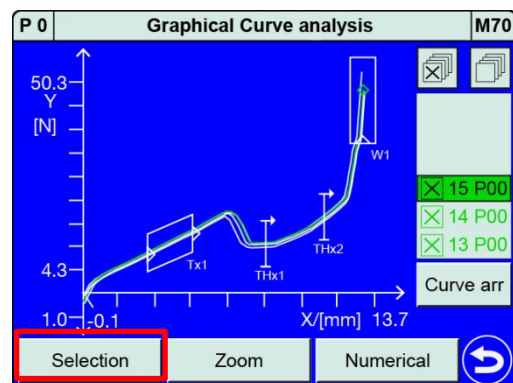

- 1 In measurement mode, tap anywhere on the touchscreen. The  icon appears in the bottom-right corner.
- 2 Tap  to open the "Configuration Main Menu".
- 3 Tap the "Curve Analysis" icon.
- 4 Tap **[Selection]**.

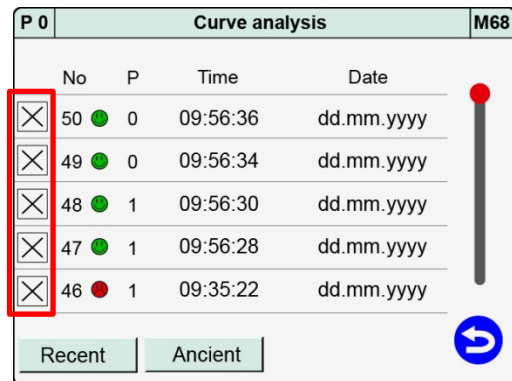

- 5 Enable the checkboxes for the measurement curves that you want to display in the curve array. By tapping on a particular row you can open additional information about this measurement.





No	P	Time	Date
<input checked="" type="checkbox"/> 50	0	09:56:36	dd.mm.yyyy
<input checked="" type="checkbox"/> 49	0	09:56:34	dd.mm.yyyy
<input checked="" type="checkbox"/> 48	1	09:56:30	dd.mm.yyyy
<input checked="" type="checkbox"/> 47	1	09:56:28	dd.mm.yyyy
<input checked="" type="checkbox"/> 46	1	09:35:22	dd.mm.yyyy

- 6 Swipe  the touchscreen or tap the scroll bar to display more measurement curves. Use the **[Recent]** and **[Ancient]** buttons to move to the latest and oldest measurement respectively.
- 7 Tap  to return to the "Graphical Curve analysis" menu.

6.5.2 Curve analysis - Zoom

In the "Graphical Curve analysis" menu (M70) you can use **[Zoom]** to adjust the scale of the X/Y graph. You can use the magnifying glass  as a particularly easy way to select a region of the graph that you want to magnify. The scale is then adjusted automatically to this region.

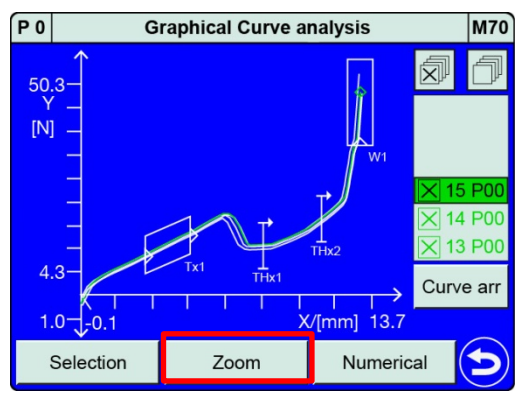

 **This is how it works**

- 1 In measurement mode, tap anywhere on the touchscreen. The  icon appears in the bottom-right corner.
- 2 Tap  to open the "Configuration Main Menu".
- 3 Tap the "Curve Analysis" icon.
- 4 Tap **[Zoom]**.

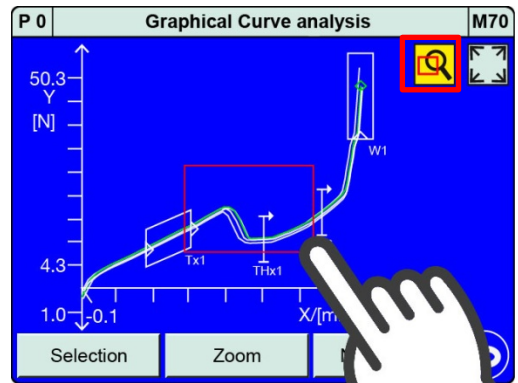

- 5 Tap  (magnifying glass), which then turns yellow. Drag your finger over the touchscreen from top left to bottom right of the area that you want to magnify. Remove your finger once you have defined the area, which is then shown magnified.





- 6 Tap  (AutoSize) to return to displaying the entire measurement curve or curve array, including all the graphical evaluation elements.
- 7 Swipe  the touchscreen to show additional measurement curves.
- 8 Tap  to return to the "Graphical Curve analysis" menu.

6.5.3 Curve analysis - Numerical

In the "Graphical Curve analysis" menu (M70) you can use the **[Numerical]** option to open details of the saved measurements. Tapping the area in the centre (**[Time]** and **[Date]**) will display the "General curve data" dataset for the measurement. In the area underneath, you can call up the entry and exit coordinates for the graphical evaluation elements.



This is how it works

- 1 In measurement mode, tap anywhere on the touchscreen. The  icon appears in the bottom-right corner.
- 2 Tap  to open the "Configuration Main Menu".
- 3 Tap the "Curve Analysis" icon.
- 4 Tap **[Numerical]**.

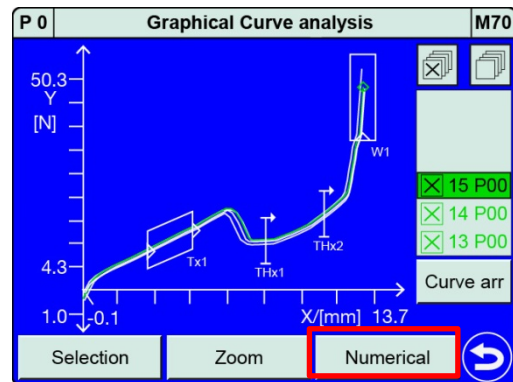

- 5 This menu shows the measurement number, the program number, the evaluation result for the measurement, the number of measured-value pairs ("No.Val") and the value-pair index for the return point ("RetPt(idx)"). Tapping in this area of the menu will open a window displaying the "General curve data".

P 0 Numerical Curve analysis M69				
No. 15		Prog 0		OK
No.Val: 1667		RetPt(idx) 1666		
17:46:08		dd.mm.yyyy		
W1	W3	Tr1	Th1	EN
W2		Tr2	Th2	
Setup is current				



P 0 Numerical Curve analysis M69				
No.		General curve data		OK
No		Start (X) 0.00000 mm Start (Y) 1.70265 N		1666
		Final (X) 13.6006 mm Final (Y) 47.3361 N		yyy
W1		Return (X) 13.6006 mm Return (Y) 47.3361 N		EN
W2				
ENTER				

DIGIFORCE® model 9311

- 6 Tap a field to display the entry and exit coordinates for the graphical evaluation element concerned.

P 0		Numerical Curve analysis			M69
No. 15		Prog 0		OK	
No.Val: 1667			RetPt(idx) 1666		
17:46:08			dd.mm.yyyy		
W1	W3	Tr1	Th1	EN	
W2		Tr2	Th2		
Setup is current					

P 0		Numerical Curve analysis			M69
No.		Window 1		OK	
No			1666		
			yyy		
W1				EN	
W2					
Evaluation OK Entry (X) 13.3267 mm Entry (Y) 32.8760 N Exit (X) 13.6006 mm Exit (Y) 47.3361 N					
ENTER					

- 7 Swipe   the touchscreen to scroll through the available measurements.
- 8 Tap  to return to the "Graphical Curve analysis" menu.

Note: If you have made changes to the instrument configuration after the measurement, this menu displays the following message: "Setup has been changed!". In this case the displayed results data may not match the current instrument configuration and therefore may be invalid or erroneous.

7 Measurement results display - Measurement mode

Note: In the "Basic setup" menu (M18), you can change the function-key assignments and the display preferences for each of the measurement menus.

The DIGIFORCE® 9311 starts automatically in measurement mode at power-up. In this operating mode, the DIGIFORCE® 9311 can perform measurements and display the resultant measurement curve and/or a range of results data and statistics. The DIGIFORCE® 9311 uses 7 different views ("Measurement menus") for this purpose, which you can scroll through by swiping ◀▶ the touchscreen.

All the measurement menus contain the global header, the individual evaluation status of the last completed measurement (on the right) and the footer displaying the function keys [F1] to [F3] with their associated function (for more information about the function keys, please see section 6.1.1 "Function key definition" on page 44). Tapping ⚙ takes you from measurement mode to the "Configuration Main Menu" (M7). You can choose to have the function keys and the ⚙ icon displayed permanently or temporarily in measurement mode.

Note: The PLC control signal "IN_AUTO" is used to prevent the instrument from switching to configuration mode.

7.1 Top-level view of measurement results

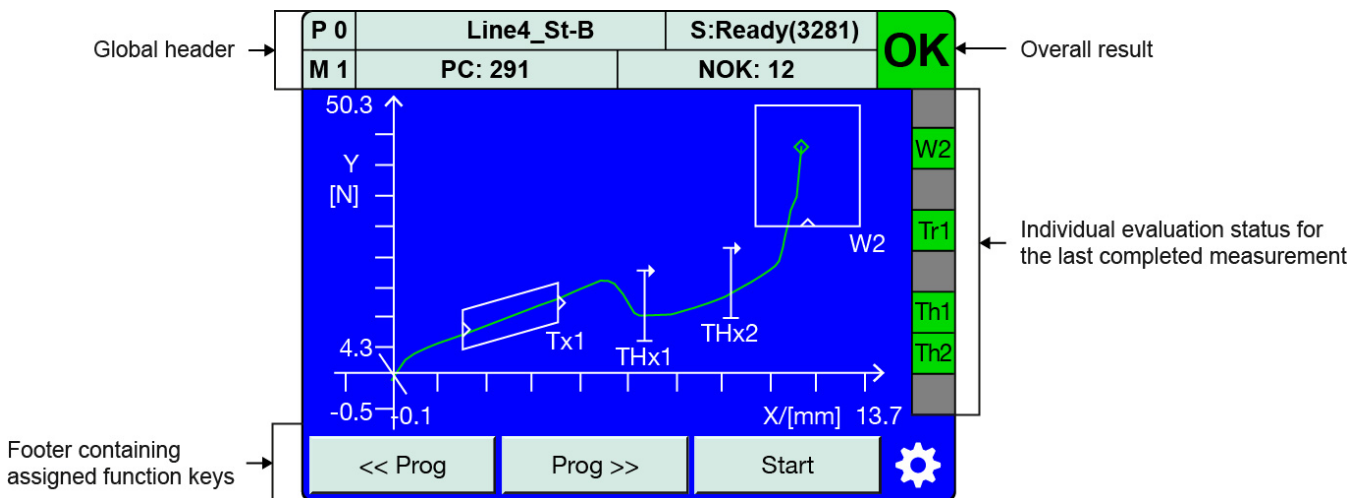

Diagram 78: Top-level view of measurement results

IMPORTANT: The PLC control signal "IN_AUTO" = 1 is used to prevent the instrument from switching to configuration mode. This access lock is indicated by the 🔒 icon.

7.1.1 Global header

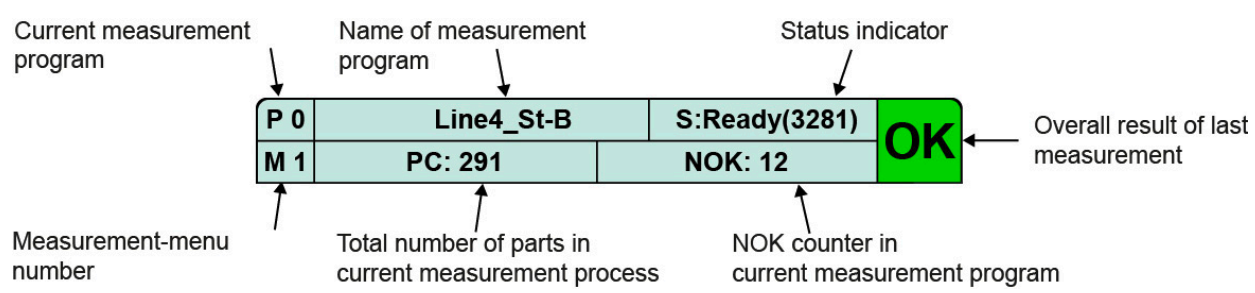



Diagram 79: Global header



7.1.2 Status/error indicator in measurement mode

S:Ready(<value>)	<p>The DIGIFORCE® 9311 is ready to perform a measurement (PLC signal: "READY=1");</p> <p>The value in brackets shows the number of measurement value pairs from the last measurement.</p> <p>S:Ready (>>5000) means that the number of measurement-value pairs in the last measurement has exceeded the maximum permitted value.</p> <p>S:Ready (OVER) means that at least one measurement channel has been overdriven during the previous measurement. This results in an overall evaluation of NOK.</p>
S:Trigger	A measurement has started, but the specified trigger event has not happened yet.
S:Measure	Measurement in progress (the overall result field changes to yellow)
S:Wait for PC	For the purpose of automated data logging, the DigiControl PC software switches handling of the READY signal to PC control in measurement mode. If a new measurement is available in the DIGIFORCE® 9311, the READY status and the "OUT_READY" control signal are not set until data logging has finished. The status "S:Wait for PC" is displayed in this phase.
Error USB	An error occurred when logging data on the USB stick (e.g. the USB stick was removed).
S:Acknowledge!	Waiting for acknowledgement in acknowledgement mode (background colour magenta).
Edit mode active	Edit mode has been opened using the relevant function button in measurement mode. The DIGIFORCE® 9311 can now switch to configuration mode despite active measurement-data logging by the DigiControl software (background colour magenta).

IMPORTANT: If the DIGIFORCE® 9311 is integrated in the PC-based logging of measurement data by the DigiControl PC software (DigiControl Measurement mode function), the status is shown as blue text. In this state, the DIGIFORCE® 9311 cannot be switched directly into configuration mode by tapping .

Note: If a measurement-channel overdrive is indicated ("S:Ready (OVER)"), you can check the live sensor values in the "Numerical test operation" menu (M58). A faulty sensor lead or a faulty sensor may cause the overdrive on the measurement channel.

7.1.3 Overall result of last measurement

Display	Meaning
	Measurement OK: every active evaluation element enabled for evaluation has been evaluated as OK.
	Measurement NOK: at least one active evaluation element enabled for evaluation has been evaluated as NOK.
	Measurement in progress

7.1.4 Individual evaluation status in measurement mode

On the right-hand side of the screen, the DIGIFORCE® 9311 indicates the individual results of the active evaluation elements. The DIGIFORCE® 9311 identifies each of these results with the relevant initial and number of the evaluation element.

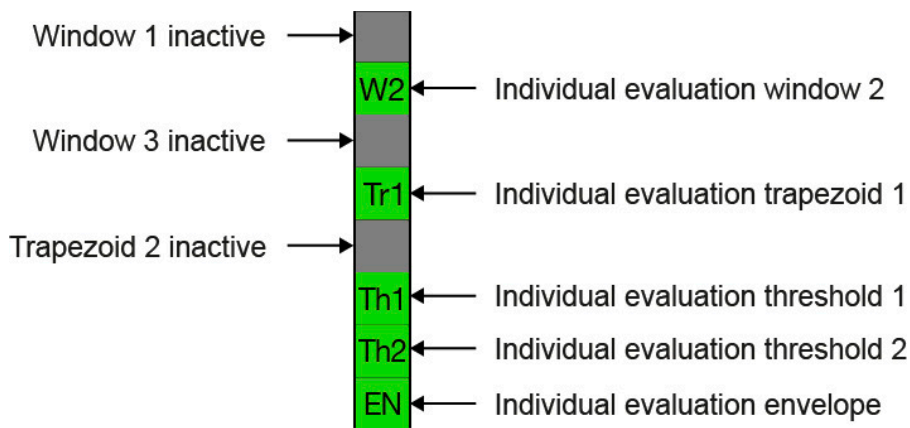

Diagram 80: Individual evaluation status

You can scroll between the following measurement menus by swiping ◀▶ the touchscreen.

No.	Description	Indicator option
1	M1 Graphical measurement curve	
2	M2 General curve data	
3	M3 Total result	Smiley or Pass / Fail
4	M4 Entry/Exit	
5	M5 User-defined values	
6	M6 Statistics	
7	M7 Order sheet	

In the "Measurement menu display control" menu (M41), you can specify whether to show/hide a measurement menu and can customize its display. For further details, please see section 6.1.5 "Measurement menus" on page 51.

7.2 M1 Graphical measurement curve

The measurement curve plotted on an X/Y graph is displayed in the "M1 Graphical measurement curve" measurement menu.

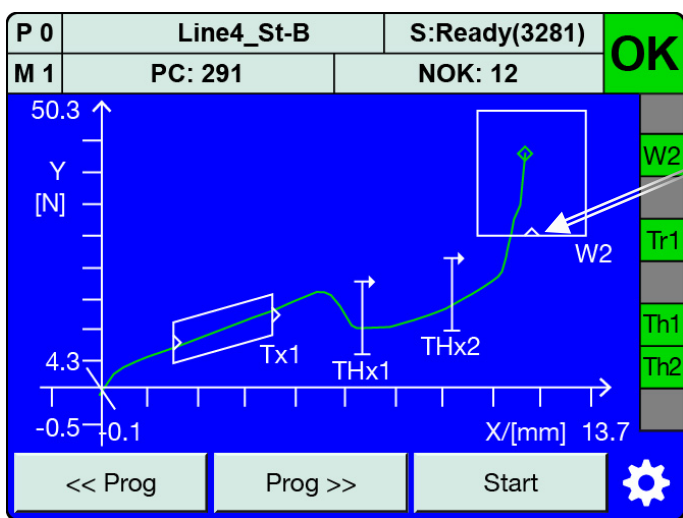

Arrows on the evaluation elements show the required entry/exit points and the crossing direction.

Diagram 81: M1 Graphical measurement curve

Setting the scale for the X/Y axes (zoom)

You can set the scale for the axes in the "Graphical test operation" menu (M59) (for details, please see section 6.3.5.1 "Graphical Test Operation - Zoom (adjust zoom for X/Y graphs)" on page 136). The scale can be adjusted and defined using "Auto" zoom or "FixScale" zoom.

Displaying a reference curve

A reference curve can be displayed to help you visually assess and analyse a live measurement curve. This must be recorded and saved in advance in the "Graphical test operation" menu (M59) (for details, please see section 6.3.5.8 "Graphical test operation – Reference curve" on page 161). The reference curve is shown in violet.

Live sensor values

You can specify that you also want the live sensor values displayed in the "M1 Graphical measurement curve" measurement menu. To do this, you must enable the "Show live values" checkbox in the "Measurement menu display control" menu (M41) (for details, please see section 6.1.5 "Measurement menus" on page 51).

Note: It is not possible to display the sensor live values and the function keys simultaneously at the bottom of the touchscreen. You can, however, show the enabled function keys for about 5 seconds by tapping the touchscreen.

7.3 M2 General curve data

The "M2 General curve data" measurement menu displays coordinate pairs (X/Y value pairs) from the "General curve data" results dataset.

P 0	Program 0		S:Ready	OK
M 2	PC: 0	NOK: 0		
	X/[mm]	Y/[N]		
Xmin	0.03056	0.05834		
Xmax	101.724	13.7215		
Ymin	86.6504	0.05834		
Ymax	101.724	13.7215		
Start	0.03056	0.05834		
Final	101.724	13.7215		
Return	101.724	13.7215		

Diagram 82: M2 General curve data

Definition of values in the "General curve data" results

Xmin	X/Y value pair at X-minimum
Xmax	X/Y value pair at X-maximum
Ymin	X/Y value pair at Y-minimum
Ymax	X/Y value pair at Y-maximum
Start	X/Y value pair at start of measurement (first measurement-value pair)
Final	X/Y value pair at end of measurement (last measurement-value pair)
Return	X/Y value pair at return point (last measurement-value pair in the forward curve segment)

7.4 M3 Total result

The "M3 Total result" measurement menu lets you display the evaluation result as a global Pass/Fail result (OK/NOK evaluation). You can opt to display the result as the text Pass/Fail or as a happy/sad smiley.

You can also add an acknowledgement function to the overall result page, which prompts for confirmation by the operator (for further details, please see section 6.1.11 "Acknowledgement function" on page 56).

M3 Total result as text display

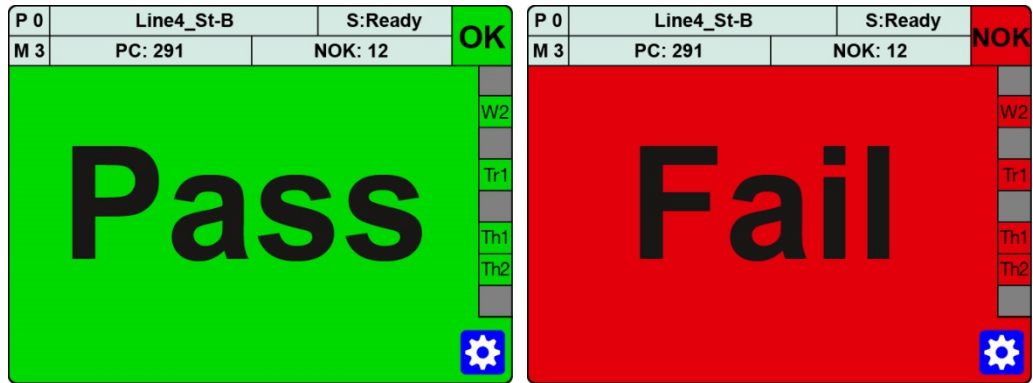

Diagram 83: M3 Total result Pass/Fail

M3 Total result using smileys

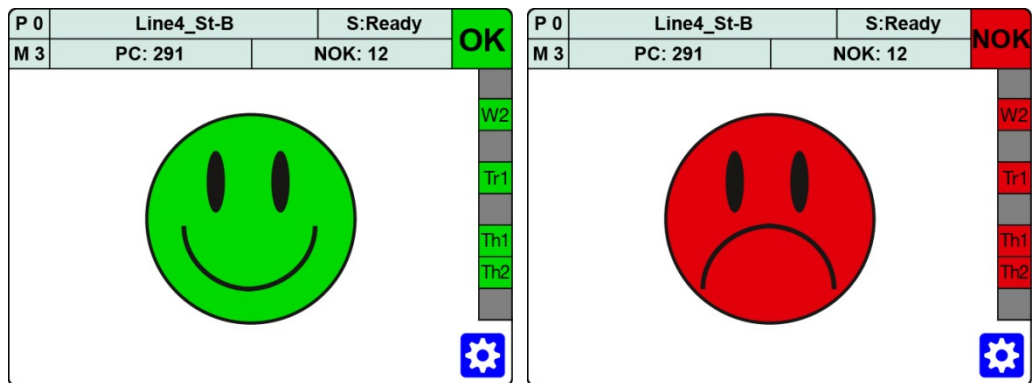

Diagram 84: M3 Total result using smileys

7.5 M4 Entry/Exit

The "M4 entry/exit" measurement menu displays the entry and exit coordinates for the active graphical evaluation element.

P 0	Line4_St-B		S:Ready	OK
M 4	PC: 291	NOK: 12		
	X/[mm]	Y [N]		
W2 Entry	10.3607	23.6583		W2
W2 Exit	<<<>>	<<<>>		Tr1
T1 Entry	2.07305	5.05834		Th1
T1 Exit	5.72411	12.7215		Th2
Thres 1	7.63056	6.83428		
Thres 2	9.84724	8.72153		



Diagram 85: M4 Entry/Exit

7.6 M5 User defined values

The "M5 User defined values" measurement menu can display up to 20 separate measurement values and results. You can select which values you want to display using the "User-def. Val." option in the "Program Setup" menu (M78) (for details, please see section 6.3.8 "User-defined values" on page 173). Please note that these values are not coordinate pairs.

P 2	Program 0		S:Ready(1523)	OK
M 5	PC: 9	NOK: 2		
1	AbsMaxY (X)	13.8900 mm		W1
2	AbsMaxY	49.8723 N		
3	TH1 Pass Y	15.1528 N		Tr1
4	TH2 Pass Y	20.0523 N		
5	W1 Entry X	13.5975 mm		Th1
6	W1 Entry Y	32.8760 N		Th2
7	W1 AbsMax Y	49.8723 N		
8	Off			



Diagram 86: M5 User-defined values

You can export the values in the User-defined tables via the optional Fieldbus interface (e.g. PROFIBUS) and via the standard communication interfaces.

7.7 M6 Statistics

The "M6 Statistics" measurement menu shows the percentage of failed parts (NOK evaluations) out of the total number of parts. It also shows the NOK percentage for each active graphical evaluation element with respect to the total number of NOK evaluations. This display can help you quickly deduce the cause of any NOK measurements.

Example of statistics from screenshot

Of the 16812 parts in total, 347 measurements were evaluated as NOK. The percentage for the total number of NOK evaluations equals 2.1%. The Threshold 1 "Th1" evaluation element was the source of 66 % of all the NOK measurements, and therefore contributed most often to the NOK overall evaluation.

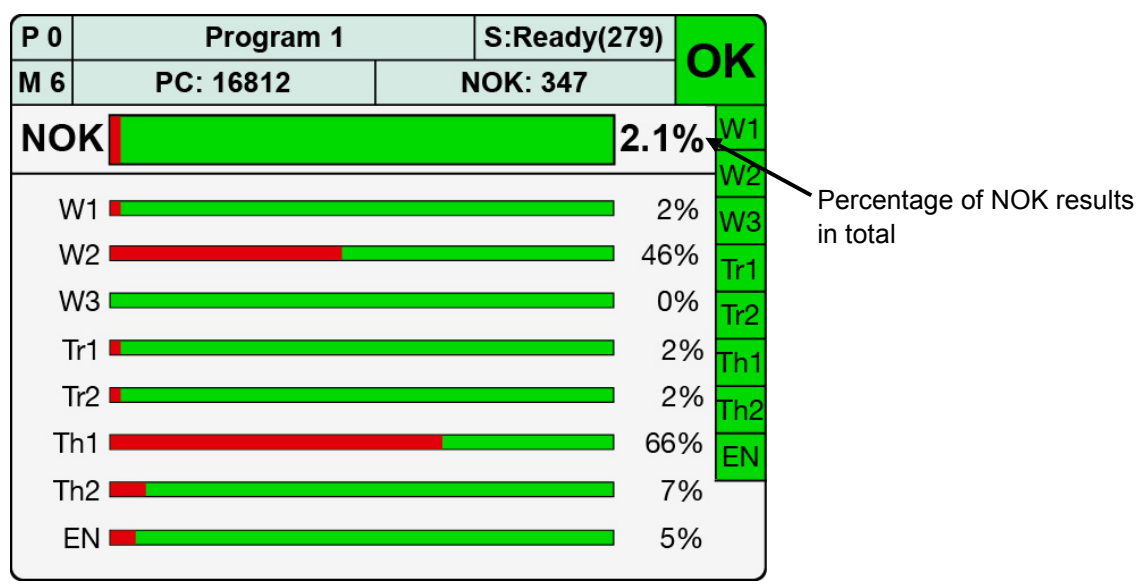

Diagram 87: M6 Statistics

7.8 M7 Order sheet

The "M7 Order sheet" measurement menu is not used for displaying specific measurement data or results. It is a "data container" via which you can transfer administrative or component-specific information for data-logging purposes. You can edit the order sheet manually in the "Order sheet" menu (M52) (for details, please see section 6.1.12 "Order sheet" on page 57). It is far more efficient, however, to perform reading/writing via the Fieldbus interface to a PLC (e.g. via PROFIBUS). In this case, the PLC can write relevant information to the container, and this information can then be saved by logging the measurement data after the measurement (e.g. using the DigiControl PC software).

The order sheet is created globally and not for a specific program, i.e. the same set of data is used whatever the measurement program.

Parameters in the "Order sheet" menu (M52)

Parameter	Meaning
Operator	Name of operator (string [64 characters])
Order number	A123456B (string [64 characters])
Batch	Z987654321A (string [64 characters])
Component	Component name (string [64 characters])
SN1	Serial number SN1 (string [64 characters])
SN2	Serial number SN2 (string [64 characters])

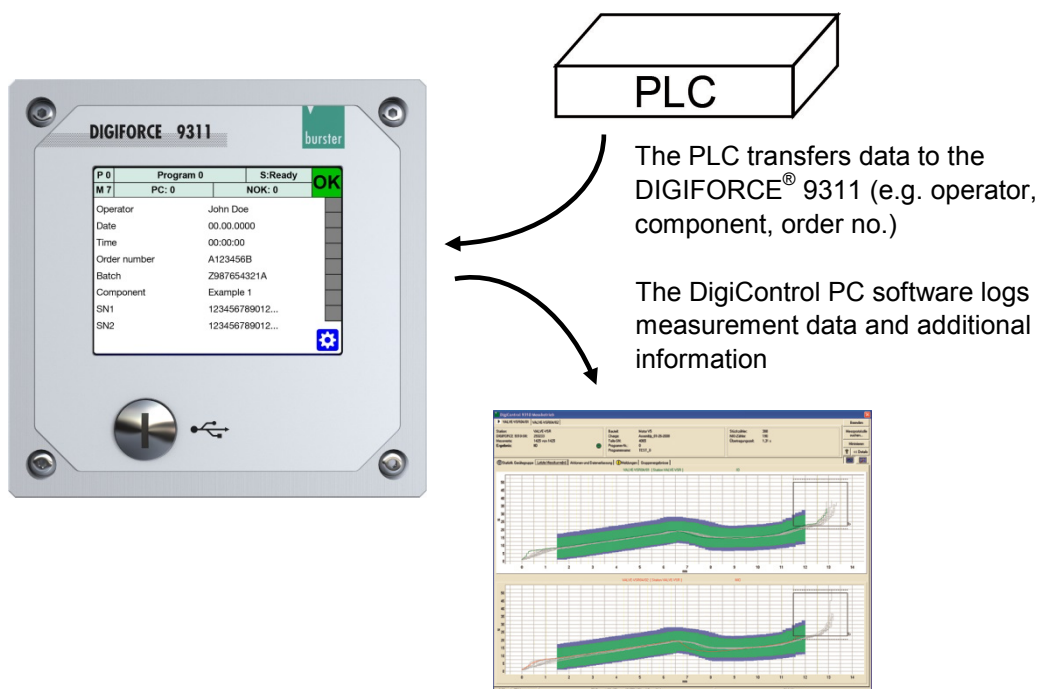

Diagram 88: M7 Order sheet

8 Signal timing diagrams

8.1 Selecting a measurement program

8.1.1 Changing the measurement program without program acknowledgement

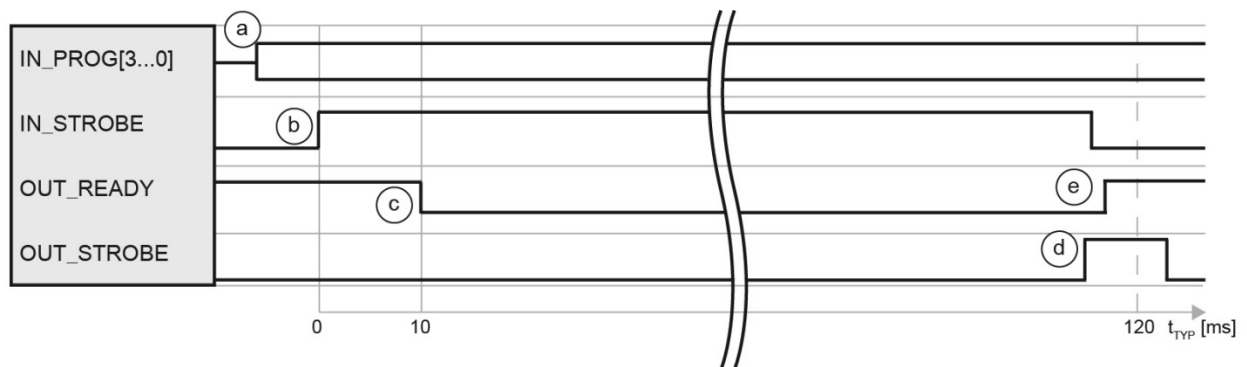

Diagram 89: Changing the measurement program without program acknowledgement

Cycle

- The controller applies the required program number (binary encoded) to the address inputs and checks whether the DIGIFORCE® 9311 is ready ("OUT_READY" = 1).
- The controller sets the strobe signal ("IN_STROBE" = 1) in order to transfer the program number.
- On detecting the strobe signal, the DIGIFORCE® 9311 sets the READY signal to "0".
- At the end of the program-selection cycle, the DIGIFORCE® 9311 enables the output signal "OUT_STROBE" as the acknowledgement for the external PLC. On detecting the "OUT_STROBE" signal from the 9311, the PLC can reset the initiating control signal "IN_STROBE" ("IN_STROBE" = 0).
- After "IN_STROBE" has been reset, the DIGIFORCE® 9311 sets the READY signal and resets "OUT_STROBE". Only then the cycle is completed.

Tip

You can connect unused address inputs permanently to Ground potential.

Note: This applies only to all unused inputs! Otherwise outputs can be triggered incorrectly if extreme interference fields exist or there are large fluctuations in the PLC supply potential with respect to Ground potential.

8.1.2 Changing the measurement program with program acknowledgement

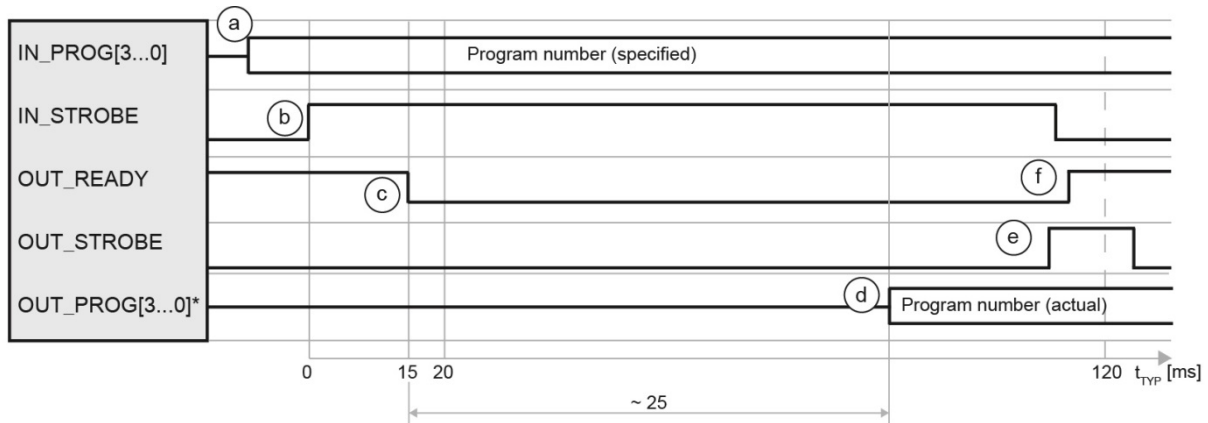

Diagram 90: Changing the measurement program with program acknowledgement

*You can define a configurable PLC output for the signals "OUT_PROG[3...0]".

Cycle

- The controller applies the required program number (binary encoded) to the address inputs and checks whether the DIGIFORCE® 9311 is ready ("OUT_READY" = 1).
- The controller sends the strobe signal ("IN_STROBE") in order to transfer the program number.
- On detecting the strobe signal, the DIGIFORCE® 9311 sets the READY signal to "0".
- The DIGIFORCE® 9311 updates the program number echoed at the address outputs ("OUT_PROG[3...0]"*) with the selected program.
- At the end of the program-selection cycle, the DIGIFORCE® 9311 enables the output signal "OUT_STROBE". On detecting the "OUT_STROBE" signal from the 9311, the PLC can receive and validate the program number "OUT_PROG[3...0]"* acknowledged by the DIGIFORCE® 9311. Then the PLC can reset the initiating control signal "IN_STROBE" ("IN_STROBE" = 0).
- After "IN_STROBE" has been reset, the DIGIFORCE® 9311 sets the READY signal and resets "OUT_STROBE". Only then the cycle is completed.

Tip

You can connect unused address inputs permanently to Ground potential.

Note: This applies only to all unused inputs! Otherwise outputs can be triggered incorrectly if extreme interference fields exist or there are large fluctuations in the PLC supply potential with respect to Ground potential.

8.2 Starting a measurement

Instead of using external signals, you can also use separate internal events to start and stop a measurement in the DIGIFORCE[®] 9311. You define the necessary settings for this in the Measurement mode configuration menu; for details, please see section 6.3.2.4 "Start/Stop mode" on page 113.

8.2.1 Measurement without measurement-data logging

Standard measurement cycle without active logging of measurement data via the communication interfaces (Ethernet, USB). For a Fieldbus interface, all result values are immediately available once "OUT_READY" = 1.

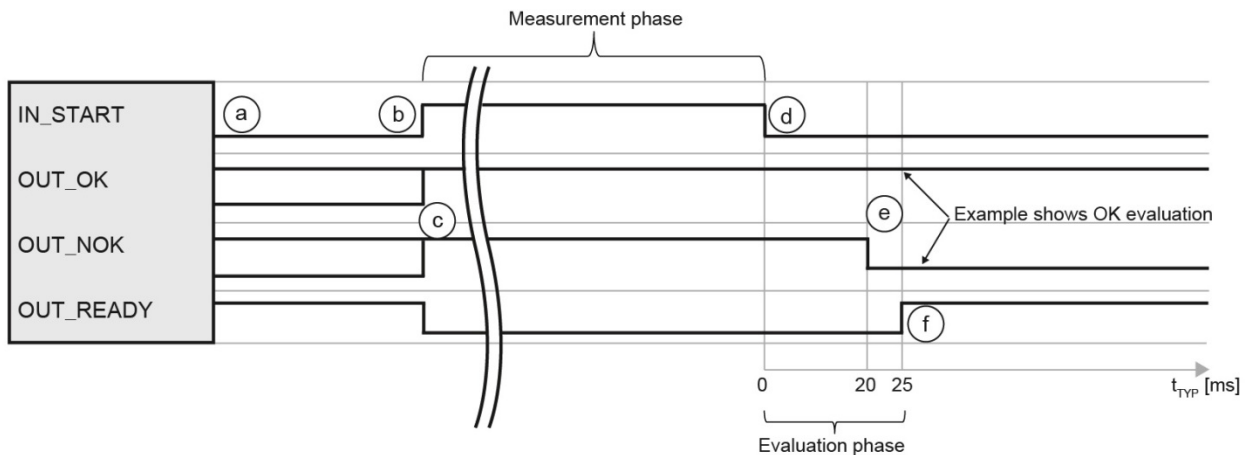

Diagram 91: Without measurement-data logging

Cycle

- a. The controller (PLC) checks whether the DIGIFORCE[®] 9311 is ready ("OUT_READY" = 1).
- b. The PLC starts the measurement with "IN_START" = 1
- c. During the measurement phase the DIGIFORCE[®] 9311 sets the signals "OUT_OK" and "OUT_NOK" to 1 as well as the signal "OUT_READY" to 0.
- d. The PLC stops the measurement by resetting the signal "IN_START" to 0.
- e. The DIGIFORCE[®] 9311 updates the result during the evaluation phase:
 "OUT_OK" = 1 and "OUT_NOK" = 0: measurement OK
 "OUT_OK" = 0 and "OUT_NOK" = 1: measurement NOK
- f. At the end of the evaluation phase, the DIGIFORCE[®] 9311 sets the signal "OUT_READY" to 1 (in standby).

Note: As soon as the process has finished, the PLC (I/O or Fieldbus) can withdraw the Start signal to stop the measurement phase. This applies only when an external Stop has been selected. If an external Stop has not been configured, the Start can be withdrawn even before the end of the process. After detecting the Stop, the DIGIFORCE[®] 9311 evaluates the recorded measured values and sets the evaluation signals OK or NOK. The other evaluation signal in each case is set to "0". Once the full sequence has finished, the DIGIFORCE[®] 9311 sets the READY signal.

8.2.2 Measurement with measurement-data logging

The DigiControl PLUS PC software for the DIGIFORCE® 9311 provides the option for automatic data logging at the end of a measurement. When data logging is enabled, the "OUT_READY" signal, which indicates that the instrument is in standby and ready to perform another measurement, is not set until data transmission is complete. The time taken for data logging depends on the choice of communication interface and on the size of the measurement curve. The time length for data logging shown in the signal timing diagram is the time typically taken when the Ethernet port is used.

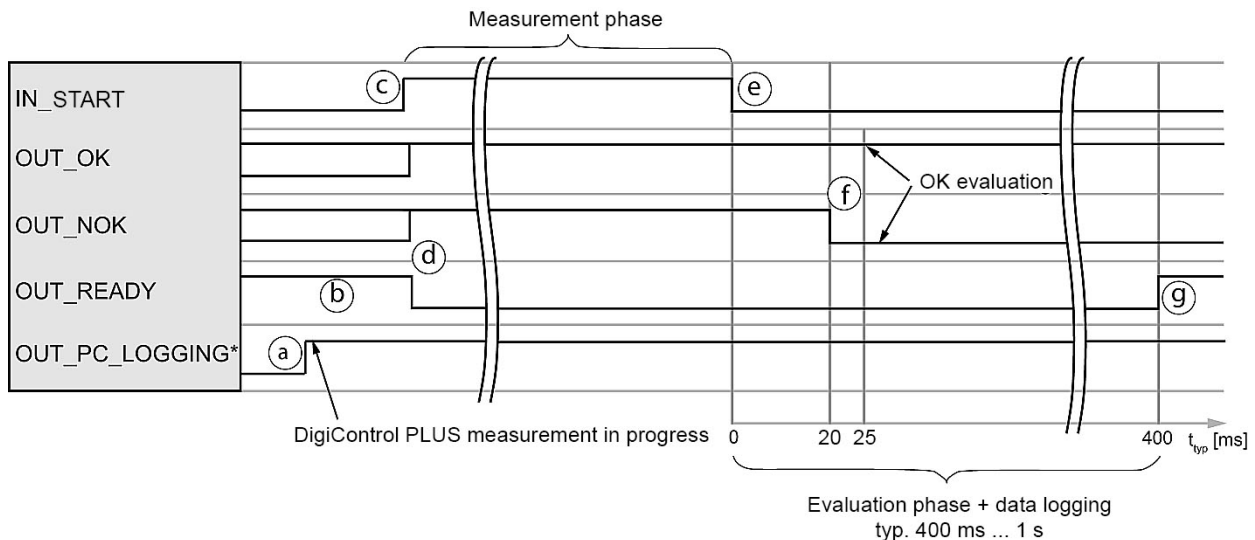

Diagram 92: With measurement-data logging

*You can define a configurable PLC output for the signal "OUT_PC_LOGGING".

Cycle

- DigiControl PLUS (PC software) sets the signal "OUT_PC_LOGGING" to 1 when measurement mode starts.
- The controller (PLC) checks whether the DIGIFORCE® 9311 is ready ("OUT_READY" = 1).
- The PLC starts the measurement with "IN_START" = 1
- During the measurement phase the DIGIFORCE® 9311 sets the signals "OUT_OK" and "OUT_NOK" to 1 and the signal "OUT_READY" to 0.
- The PLC stops the measurement by resetting the signal "IN_START" to 0.
- The DIGIFORCE® 9311 updates the result during the evaluation phase:
 "OUT_OK" = 1 and "OUT_NOK" = 0: measurement OK
 "OUT_OK" = 0 and "OUT_NOK" = 1: measurement NOK
- At the end of the evaluation phase, the DIGIFORCE® 9311 sets the signal "OUT_READY" to 1 (in standby).
 DigiControl PLUS sets "OUT_PC_LOG = 0" at the end of the measurement.

Tip

To optimize cycle times, the PLC can retrieve the OK/NOK evaluation immediately after the measurement rather than waiting for the READY signal, which it can check before the next measurement.

8.2.3 Measurement using data logging on USB stick (READY control enabled)

When data logging on a USB stick is active, for each measurement a data entry is made on the USB stick plugged into the rear of the DIGIFORCE® 9311 (please see section 6.1.13 "USB flash" on page 57).

Note: If you wish to log the measurement data on the USB stick, you need to enable data logging in each measurement program concerned.

If an access error for the USB stick occurs when USB-stick data logging is active (e.g. if the USB stick has been removed), then "USB error" is displayed in the status indicator in measurement mode.

You can opt to disable the READY control if you do not want USB-stick data logging to be performed in sync with the READY signal (please see section 6.1.13 "USB flash" on page 57).

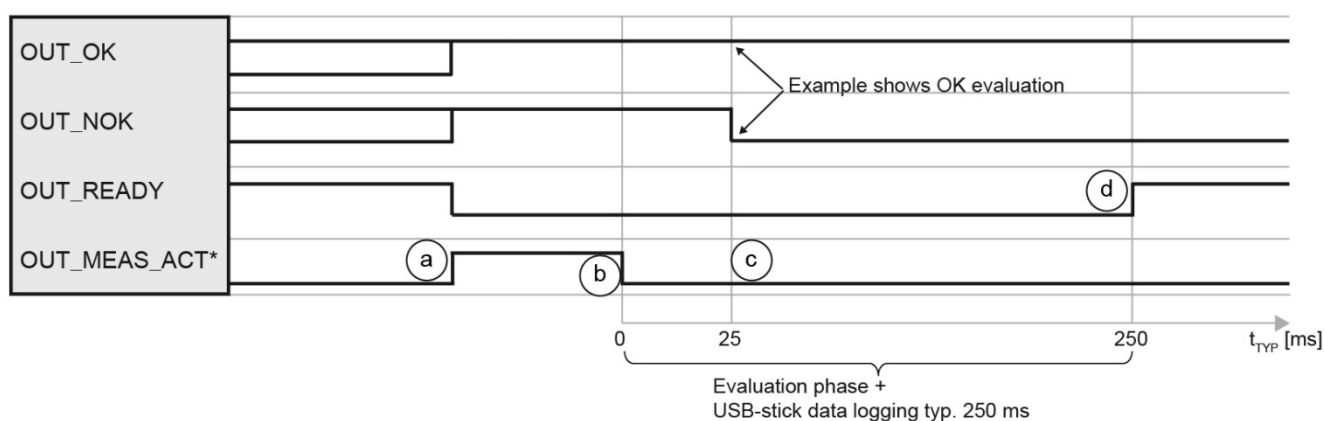

Diagram 93: Measurement with data logging on USB stick

*You can define a configurable PLC output for the signal "OUT_MEAS_ACT".

Note: When data logging on USB stick is active, the *.csv file is generated and a "HEADER" saved in the file after the first measurement. This introduces a one-off delay (READY = 1) of typically 1 to 2 seconds.

Cycle

- Depending on the option selected, the DIGIFORCE® 9311 uses an internal condition or the control signal "IN_START" to start a measurement.
- During the measurement phase the DIGIFORCE® 9311 sets the signals "OUT_OK" and "OUT_NOK" to 1 as well as the signal "OUT_READY" to 0. The DIGIFORCE® 9311 can signal the actual measurement phase using the output "OUT_MEAS_ACT" = 1 (measurement active).
- The evaluation phase in the DIGIFORCE® 9311 starts once the active measurement phase ends ("OUT_MEAS_ACT" = 0).
- The DIGIFORCE® 9311 updates the result during the evaluation phase:
- "OUT_OK" = 1 and "OUT_NOK" = 0: measurement OK
"OUT_OK" = 0 and "OUT_NOK" = 1: measurement NOK

At the end of the evaluation phase, the instrument creates or accesses the *.csv file on the USB stick (please see section 6.1.13 "USB flash" on page 57).

- Once the evaluation phase and USB-stick data logging have finished, the DIGIFORCE® 9311 sets the signal "OUT_READY" to 1 (in standby).

8.3 External tare

8.3.1 Without tare warning

Standard cycle without monitoring of the tare warning limit using measurement channel "Y1" as an example.

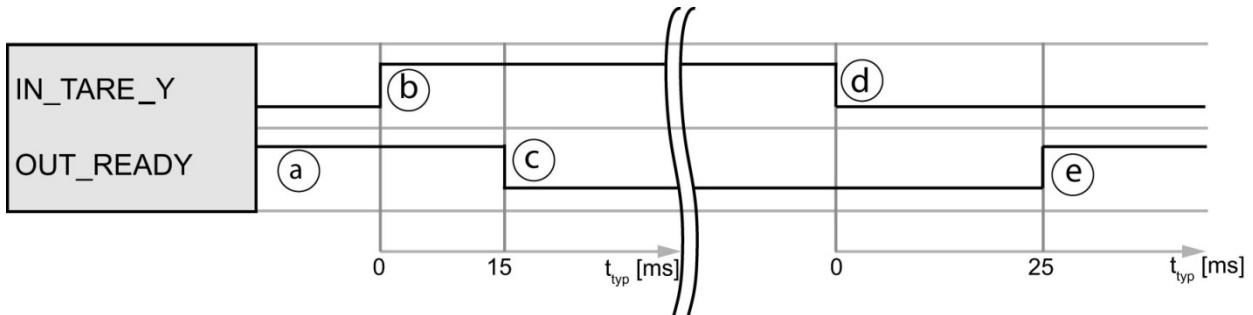

Diagram 94: Without tare warning

Cycle

- The PLC first checks whether the instrument is ready, i.e. if "OUT_READY" = 1.
- The PLC initiates the tare procedure with "IN_TARE_Y" = 1.
- The DIGIFORCE[®] 9311 then resets "OUT_READY" to 0.
- On detecting "OUT_READY" = 0, the PLC can withdraw the tare request ("IN_TARE_Y"=0).
- Once the process has finished, the DIGIFORCE[®] 9311 sets "OUT_READY" = 1 (in standby).

8.3.2 With tare warning

The DIGIFORCE® 9311 can generate a warning if the sensor signal to be tared exceeds a configurable threshold value. You can enable and set this threshold in the "Channel settings" menu (M21) (for further details, please see section 6.3.1 "Channel settings" on page 71).

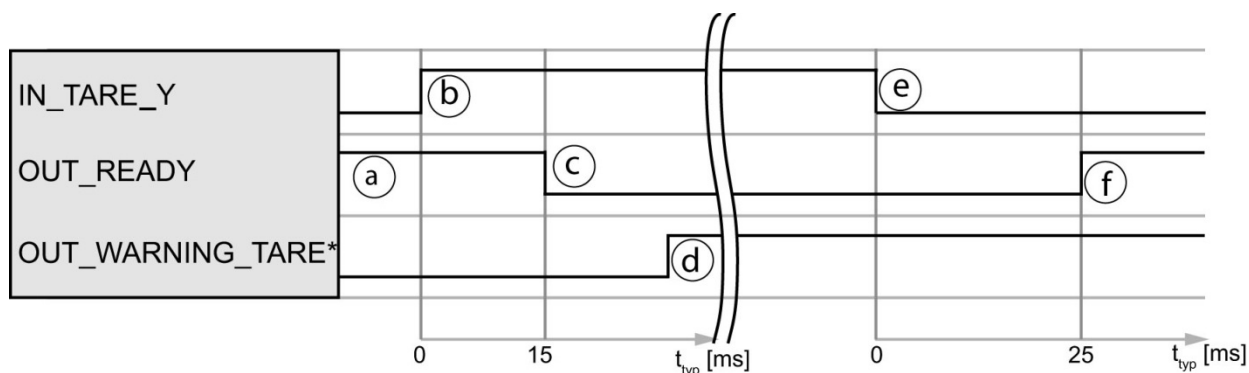

Diagram 95: With tare warning

*You can define a configurable PLC output for the signal "OUT_WARNING_TARE".

Cycle

- The PLC first checks whether the instrument is ready, i.e. if "OUT_READY" = 1.
- The PLC initiates the tare procedure with "IN_TARE_Y" = 1.
- The DIGIFORCE® 9311 then resets "OUT_READY" to 0.
- If the live sensor signal exceeds the set warning limit, the DIGIFORCE® 9311 sets the output "OUT_WARNING_TARE".
- On detecting "OUT_READY" = 0, the PLC can use "IN_TARE_Y" to stop the tare process.
- At the end of the cycle, the DIGIFORCE® 9311 sets "OUT_READY" to 1 (in standby). The PLC can now evaluate the "OUT_WARNING_TARE" warning output signal.

Note: The warning is withdrawn if the warning condition was no longer met in another tare process, or if "Tare" has been disabled.

8.4 Online signals

8.4.1 Window evaluation with online signal

For the "Window" evaluation element you can specify that the DIGIFORCE® 9311 enables the "OUT_NOK_ONL" online signal if a window evaluation criterion is infringed. This function is often used to monitor the initial-contact region of press-fit processes.

If the curve exits the window incorrectly, for instance because misalignment of the parts to be joined causes an unexpected rise in force, the DIGIFORCE® 9311 enables the associated online signal. This can be used to stop the press-fit process early to pre-empt any damage to the equipment, tools or workpieces. The DIGIFORCE® 9311 resets the online signal "OUT_NOK_ONL" again once a new measurement starts.

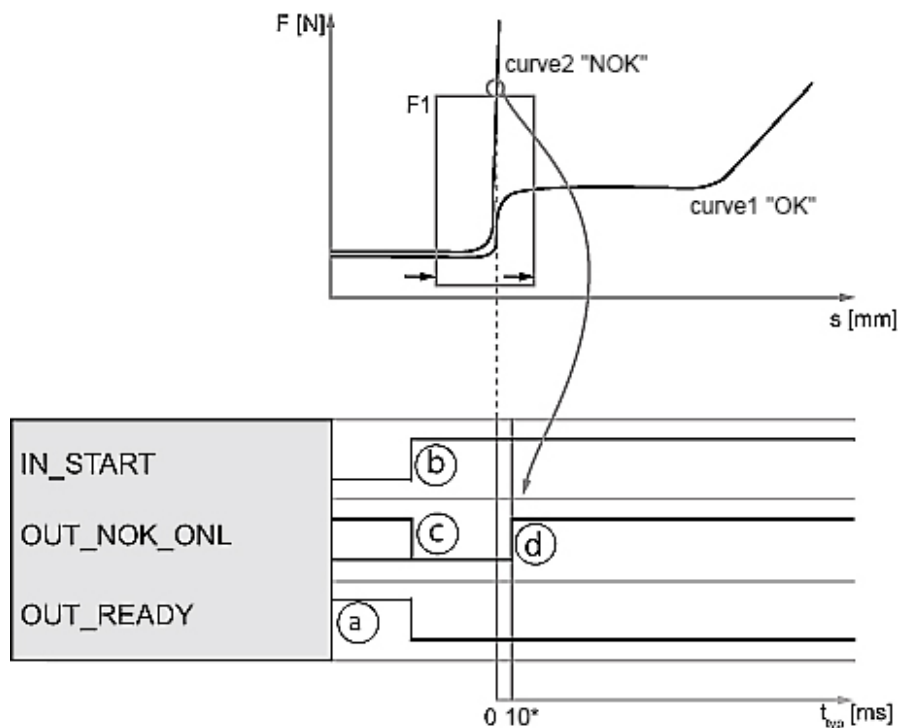

Diagram 96: Window evaluation with online signal

*The chosen signal-sampling method and filter parameters may increase the typical delay shown here.



Cycle

- The PLC first checks whether the instrument is in standby and ready to measure, i.e. if "OUT_READY" = 1.
- The PLC starts the measurement with "IN_START" = 1
- During the measurement phase, the DIGIFORCE® 9311 sets "OUT_NOK_ONL" to 0.
- If the evaluation window is infringed when online evaluation is in use, the DIGIFORCE® 9311 activates the online signal.
- Valid crossing (e.g. from left to right without infringement): "OUT_NOK_ONL" = 0.
- If there is an infringement (e.g. curve exits through top of window), the DIGIFORCE® 9311 sets the online signal to "1" ("OUT_NOK_ONL" = 1).

DIGIFORCE® model 9311

8.4.2 Online switching signals S1 to S6

The DIGIFORCE® 9311 can enable the switching signals S1 to S6 in measurement mode and in test operation if a measurement exceeds a set value.

	 <h3 style="margin: 0;">WARNING</h3>
	<p>NOT a substitute for safety devices and protective equipment</p> <p>The online switching signals S1 to S6 are NOT a substitute for safety devices and protective equipment.</p> <p>Use safety devices and protective equipment.</p>

Note: The switching signals S1 to S6 do not meet the requirements of a safety switch. It is the responsibility of the owner of the complete system, such as a press, to equip the system with the required safety devices and protective equipment.

8.4.2.1 Switching signals for X-channel with "Absolute" reference

The DIGIFORCE® 9311 sets an X-channel switching signal when the reading on the X-channel exceeds the set value with respect to the "Absolute" reference. If the reading falls below the set value, the DIGIFORCE® 9311 resets the signal back to its default status. In the "Absolute" reference case, the DIGIFORCE® 9311 uses the zero point of the sensor configured for this channel as the reference.

The DIGIFORCE® 9311 can set/reset the signal in measurement mode both in standby (ready to measure) and during an active measurement.

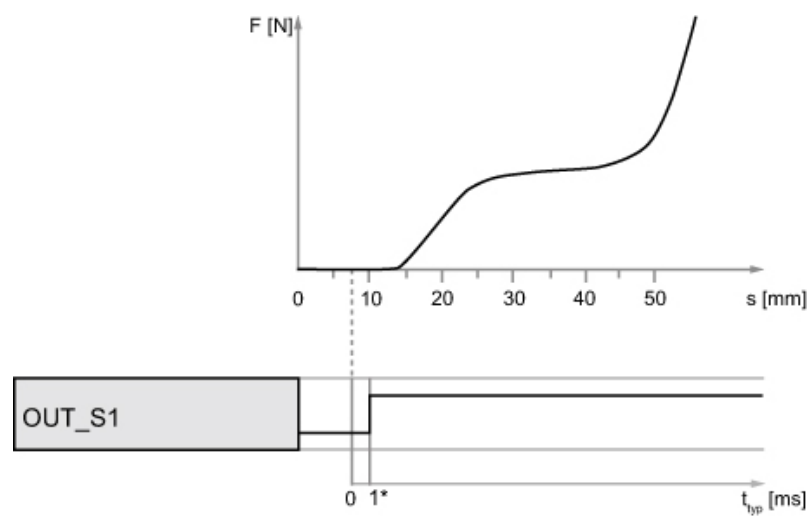

Diagram 97: Switching signals for X-channel with "Absolute" reference

"OUT_S1" configuration	
Channel	X
Value	7.5 mm
	Active high
Reference	Absolute

*Low-frequency low-pass filtering (filter value in channel settings) may extend the typical delay shown.

8.4.2.2 Switching signals for X-channel with "Trigger" reference

The DIGIFORCE® 9311 can only set/reset the X-channel switching signal with trigger reference during an active measurement, i.e. after the trigger event.

The reference for the X-channel is the trigger event, for instance this may be the contact force of a press ram on a component.

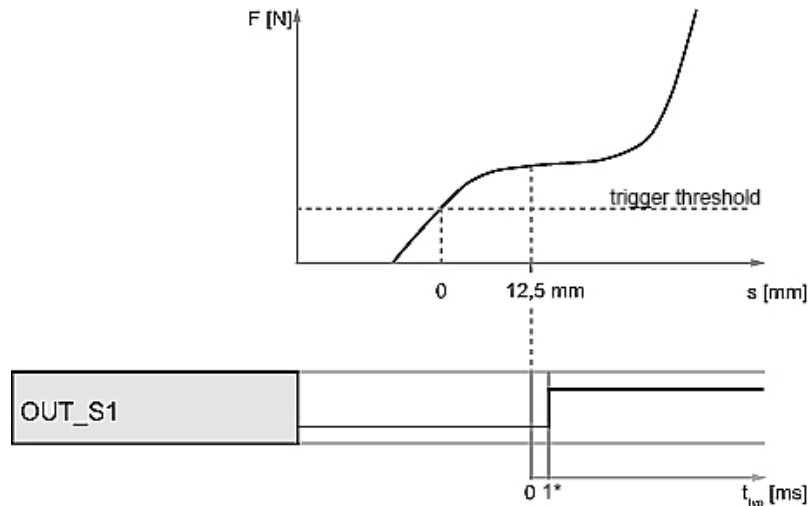

Diagram 98: Switching signals for X-channel with "Trigger" reference

"OUT_S1" configuration	
Channel	X
Value	12.5 mm
	Active high
Reference	Y trigger

*Low-frequency low-pass filtering (filter value in channel settings) may extend the typical delay shown.

8.4.2.3 Switching signals for Y-channel

The DIGIFORCE® 9311 sets a Y-channel switching signal when the reading on the Y-channel exceeds the specified Y-channel value. If the reading falls below the set value, the DIGIFORCE® 9311 resets the signal back to its default status. The signal can be set/reset in measurement mode when the instrument is in standby (ready to measure) and during an active measurement.

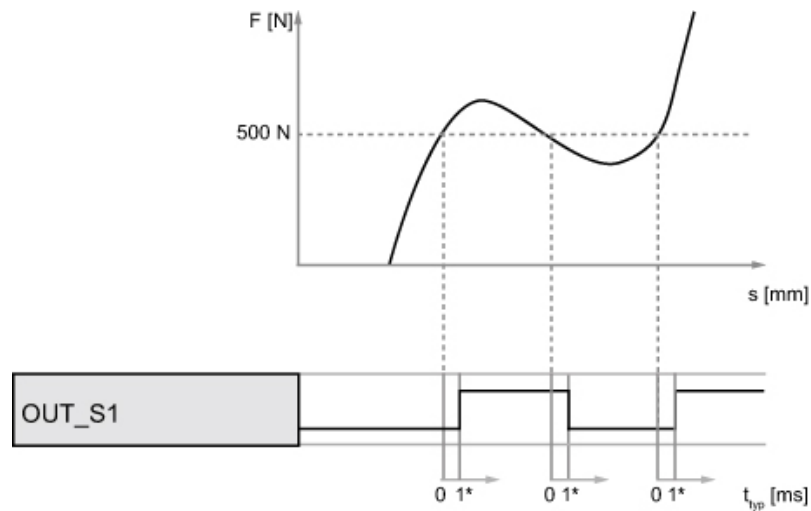

Diagram 99: Switching signals for Y-channel

"OUT_S1" configuration	
Channel	Y
Value	500 N
	Active high

*Low-frequency low-pass filtering (filter value in channel settings) may extend the typical delay shown.

8.5 Acknowledgement function

You can use the DIGIFORCE® 9311 Acknowledgement function to control indicator lights and a buzzer directly for visual and acoustic signalling of the OK/NOK evaluation. The DIGIFORCE® 9311 can also handle an acknowledge input for OK/NOK components where this is required. This acknowledgement function is linked to the "OUT_ACK_LOCK" lock output.

8.5.1 Example of an NOK evaluation for the following configuration

"Acknowledgement function" configuration	
Acknowledgement function	ON
Acknowledge OK-parts	OFF
Acknowledge NOK-parts	ON

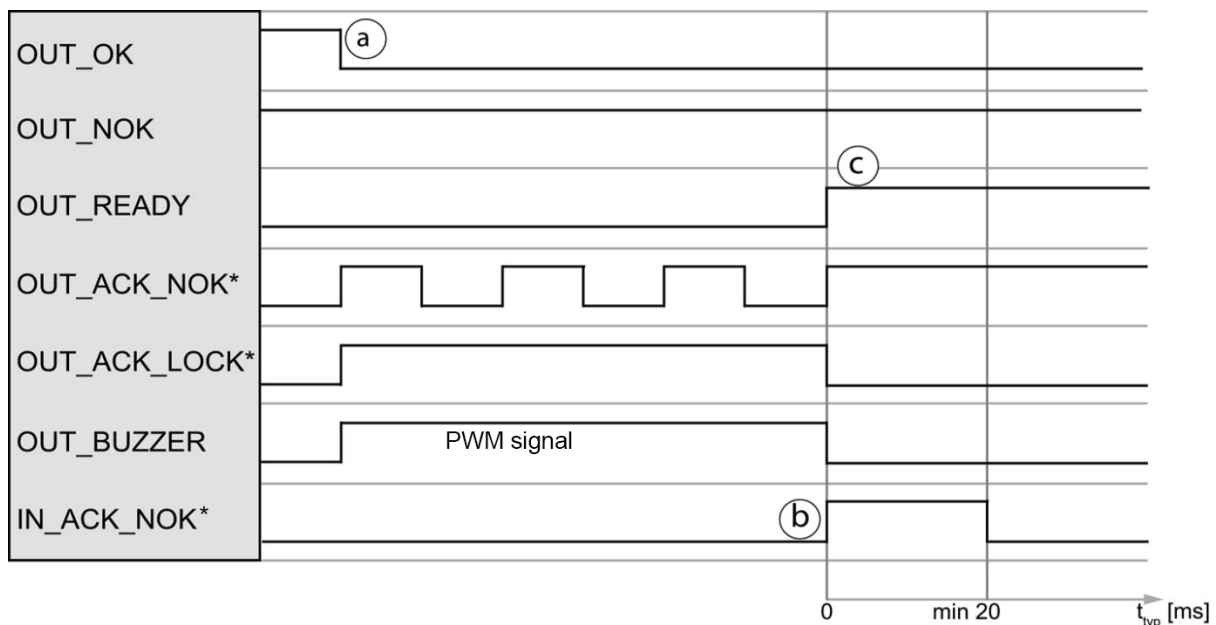

Diagram 100: Example of an NOK evaluation

*You can define a configurable PLC output for the output signals "OUT_ACK_NOK" and "OUT_ACK_LOCK". You can define a configurable PLC input for the signal "IN_ACK_NOK".

Cycle

- During the evaluation phase following a measurement, the DIGIFORCE® 9311 updates the control signals for the evaluation "OUT_OK" and "OUT_NOK" (in this case "OUT_NOK" = 1). In addition, the DIGIFORCE® 9311 activates the "OUT_ACK_NOK" indicator-light signal (flashing), sets the lock output signal "OUT_ACK_LOCK" to 1 and activates the buzzer output "OUT_BUZZER" (PWM signal).
- On detecting the acknowledgement from the user ("IN_ACK_NOK" = 1), the DIGIFORCE® 9311 sets the indicator-light signal "OUT_ACK_NOK" to 1 (solid light). The DIGIFORCE® 9311 simultaneously sets the lock output signal "OUT_ACK_LOCK" to 0 and the buzzer output "OUT_BUZZER" to 0.
- At the end of the cycle, the DIGIFORCE® 9311 sets "OUT_READY" to 1 (in standby). The indicator-light signal "OUT_ACK_NOK" remains active until the start of the next measurement.

8.5.2 Example of an NOK evaluation (without acknowledgement)

Configuration	
Acknowledgement function	ON
Acknowledge OK-parts	OFF
Acknowledge NOK-parts	OFF

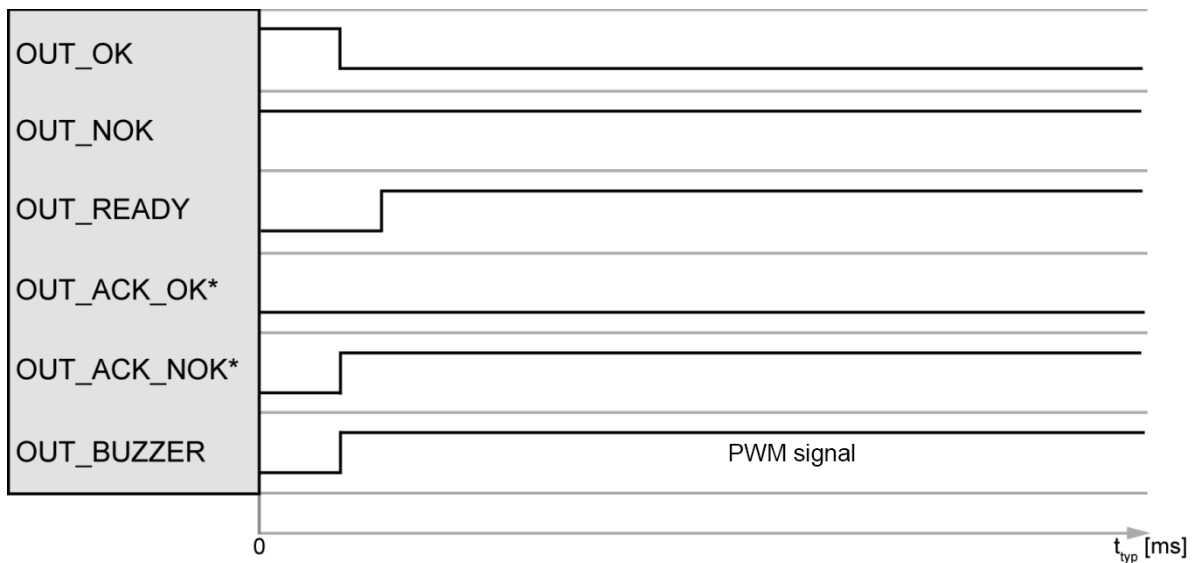

Diagram 101: Example of an NOK evaluation (without acknowledgement)

*You can define a configurable PLC output for the signals "OUT_ACK_OK" and "OUT_ACK_NOK".

8.5.3 Example of an OK evaluation (without acknowledgement)

Configuration	
Acknowledgement function	ON
Acknowledge OK-parts	OFF
Acknowledge NOK-parts	OFF

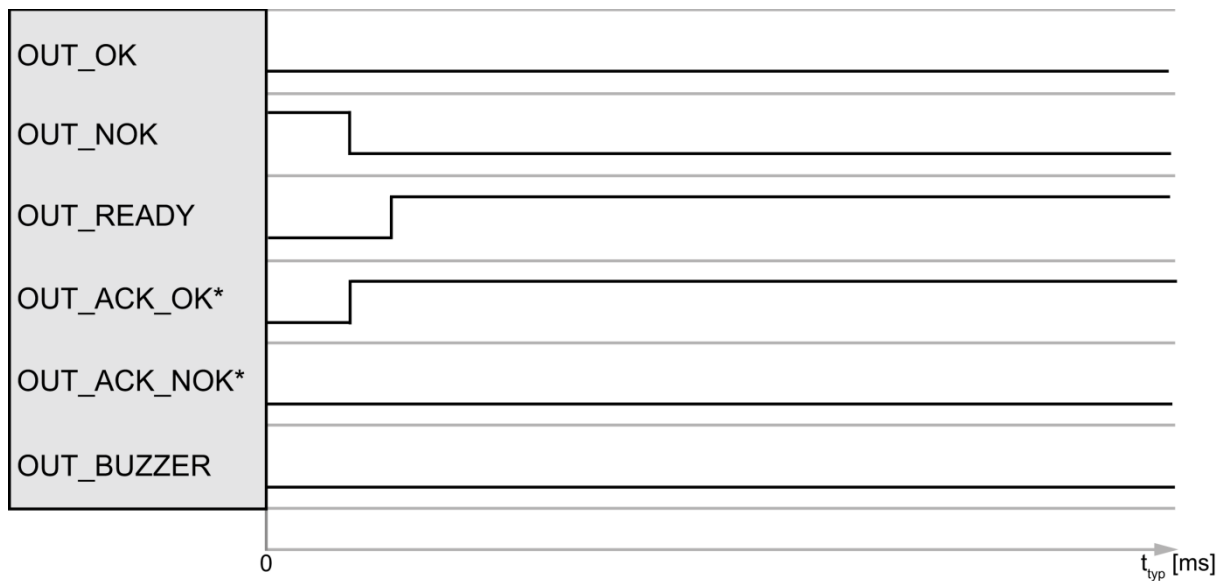

Diagram 102: Example of an OK evaluation (without acknowledgement)

*You can define a configurable PLC output for the signals "OUT_ACK_OK" and "OUT_ACK_NOK".

Note: The buzzer is active here until the start of the next measurement.

8.6 External actuation of a statistics reset

You can use the "IN_RESET" control signal to reset the part counter and NOK counter and also the evaluation element statistics. The DIGIFORCE® 9311 resets the statistics for all the measurement programs in this case.

The following values are reset by this function:

- Part counter and NOK counter for all measurement programs
- NOK percentage for all measurement programs

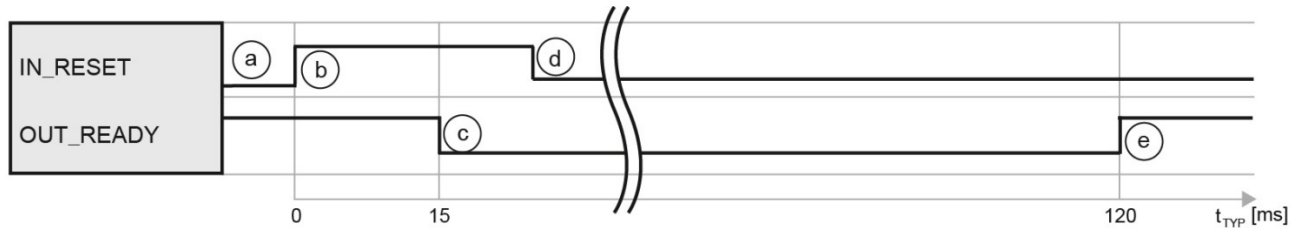

Diagram 103: External actuation of a statistics reset

Cycle

- The PLC first checks whether the instrument is ready, i.e. if "OUT_READY" = 1.
- The PLC initiates the reset process with "IN_RESET" = 1.
- The DIGIFORCE® 9311 then resets "OUT_READY" to 0.
- On detecting "OUT_READY" = 0, the PLC withdraws the reset request with "IN_RESET" = 0.
- At the end of the cycle, the DIGIFORCE® 9311 sets "OUT_READY" to 1 (in standby).

8.7 External actuation of a sensor test

You can use the "IN_STEST" signal to run the "sensor test" configured in the DIGIFORCE[®] 9311. In this test, you can check the sensor signals from measurement channels X and Y against a stored value including any tolerance that has been set.

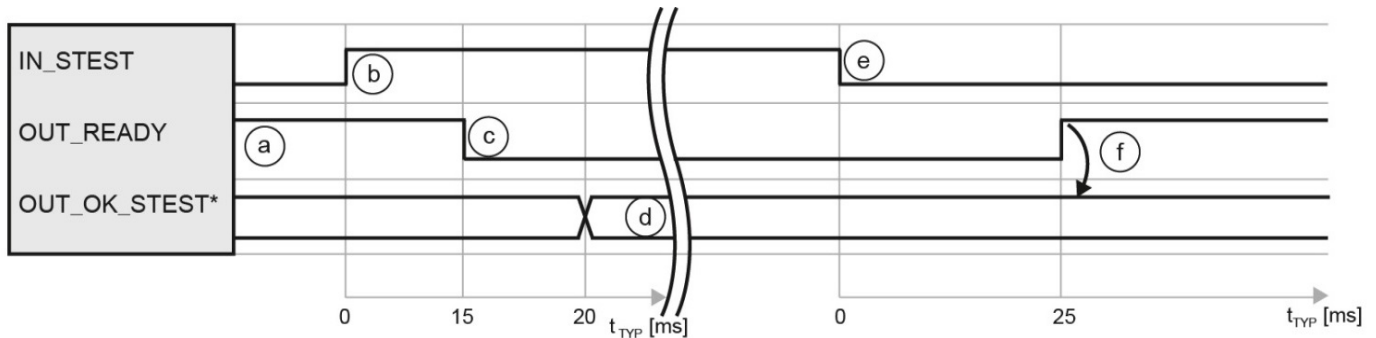

Diagram 104: External actuation of a sensor test

*You can define a configurable PLC output for the signal "OUT_OK_STEST".

Cycle

- The PLC first checks whether the instrument is ready, i.e. if "OUT_READY" = 1.
- The PLC initiates the sensor test with "IN_STEST" = 1.
- The DIGIFORCE[®] 9311 then resets "OUT_READY" to 0.
- The DIGIFORCE[®] 9311 updates the result of the sensor test:

"OUT_OK_STEST" = 0	sensor test = NOK
"OUT_OK_STEST" = 1	sensor test = OK
- On detecting "OUT_READY" = 0, the PLC can set "IN_STEST" to 0 to stop the process.
- Once the process has finished, the DIGIFORCE[®] 9311 sets "OUT_READY" = 1 (in standby). The PLC can now evaluate the "OUT_OK_STEST" result.

9 Customer Services for your DIGIFORCE[®] 9311

To complement the DIGIFORCE[®] 9311 package you have purchased, burster praezisionsmesstechnik gmhb & co kg offers the following customer services centred on the DIGIFORCE[®] family:

- On-site support for preparing the instrument for use
- Product training (burster in-house or on-site)
- Initial calibration and recalibration, including sensors

To inquire about our customer services for your DIGIFORCE[®] 9311, please telephone our Service department on +49 7224 645-53, or email: service@burster.com (Germany only). If you are outside Germany, you should contact your burster agent (see also www.burster.com).

10 Technical data

Please refer to the data sheet for the technical specification. You can obtain the latest data sheet and additional information on the DIGIFORCE[®] 9311 from <http://goo.gl/muUe7D> or simply use the QR code below:



10.1 Electromagnetic compatibility

10.1.1 Interference immunity

Interference immunity in compliance with EN 61326-1:2013
Industrial environment

10.1.2 Interference emission

Interference emission in compliance with EN 61326-1:2013

11 Accessories available

Please refer to the data sheet for details of the accessories available. You can obtain the latest data sheet and additional information on the DIGIFORCE[®] 9311 from <http://goo.gl/muUe7D> or simply use the QR code below:



11.1 Software

The data sheet contains details of the various versions of the DigiControl PC software. You can obtain the latest data sheet and additional information on the DIGIFORCE[®] 9311 from <http://goo.gl/muUe7D> or simply use the QR code below:



12 Disposal



Battery disposal

In Germany, the end user is legally obliged to return all used batteries, and it is illegal to dispose of batteries in the household waste. This law may also affect you as purchaser of the instrument described here. Please dispose of your used batteries properly and in accordance with national statutory regulations. Either take them to the relevant collection point in your organisation or to the collection points provided by your local authority, our company or any battery retail outlet.

To avoid short circuits, mask the poles of the batteries for storage and disposal.

Instrument disposal

If your instrument is no longer usable, please comply with your legal obligations by disposing of the instrument described here in accordance with statutory regulations. You will then be helping to protect the environment!

13 Index

"

"Absolute" · 19
"Window" · 202
"Window" · 29, 115, 116, 117, 120, 134, 136, 138, 140, 180

A

Absolute maximum · 117
Absolute minimum · 117
Absolute" · 108, 111, 203
Acknowledgement function · 43, 44, 46, 56, 191, 206, 207, 208

B

Basic setup · 43, 71

C

Channel settings · 17, 50, 62, 70, 71, 72, 77, 81, 86, 90, 92, 95, 99, 104, 201
Connector A · 30, 31, 32, 33, 35, 72, 74
Connector B · 17, 27, 33, 34, 35, 36, 72, 92, 101
Crossing · 20, 124, 125, 126, 127, 150, 151, 202

D

Date and time · 43, 53
DigiControl PC software · 37, 42, 50, 54, 57, 187, 194, 213

E

Entry · 115, 116, 119, 121, 123, 129, 140, 141, 145, 146, 156, 157, 158
Envelope" · 115, 128, 129, 134, 136, 155, 157, 158
Ethernet · 21, 24, 37, 54, 55, 197, 198
EtherNet/IP · 67, 68
Exit · 20, 115, 116, 117, 119, 121, 123, 124, 130, 140, 141, 145, 146, 202

F

Final force" · 109, 110, 111

Function keys · 10, 23, 44, 45, 56, 172, 186

G

General curve data · 173, 174
Global header · 186
Graphical evaluation elements · 16, 20, 22, 60, 115
Graphical test operation · 22, 70, 115, 128, 134, 135, 136, 137, 138, 139, 140, 142, 143, 144, 145, 147, 148, 149, 150, 152, 153, 154, 155, 157, 159, 160, 161, 162, 163, 164, 168, 170, 189

I

Individual evaluation · 60, 116, 120, 124

L

Live values · 22, 51, 165, 166, 168, 187, 189

M

Measurement curve reference · 107
Measurement menu · 189, 190, 191, 192, 193, 194
Measurement menus · 43, 51, 53, 175, 186, 188, 189
Measurement mode · 50, 70, 106, 107, 108, 110, 111, 112, 113, 132, 133, 197

N

Numerical test operation · 20, 22, 70, 165, 166, 167, 168, 169, 170

O

Online evaluation · 109, 110, 118, 119, 202
Online switching points · 21, 132, 133, 170
Order sheet · 43, 51, 57, 58, 59, 60, 188, 194
Overall result · 51, 60, 187, 188, 191

P

Pass/Fail · 51, 191
Password protection · 49, 50, 186
Personnel · 13, 56
Piezoelectric · 17, 24, 27, 36, 72, 101, 102, 103, 105
PLC inputs · 29, 43, 48, 56

PLC outputs · 28, 29, 43, 46, 56, 119, 165, 169, 170, 196
Potentiometer · 17, 30, 72, 74, 75, 76, 78, 79, 80, 166
Potentiometric sensors · 31, 74, 81
PROFIBUS · 24, 38, 64, 169, 192, 194, 197
PROFINET · 65, 66, 169

R

Range of functions · 16
Reference · 19, 106, 107, 108, 109, 110, 111, 132, 133, 203, 204
Reference line“ · 110, 111

S

Sensor test · 21, 29, 44, 46, 48, 50, 70, 134, 171, 172, 210
Signal sampling · 106, 107, 202, 203, 204, 205
Smiley · 51, 188, 191
Standard signal · 24, 30, 31, 32, 33, 35, 72, 83, 84, 85, 86, 87, 88, 89, 90, 91, 101, 166
Status indicator · 187
Strain gauge sensors · 17, 20, 33, 34, 35, 92, 93, 97, 99, 201

T

Tare · 44, 74, 79, 80, 83, 88, 89, 92, 97, 98, 134, 168, 172, 200, 201
TEDS · 18, 30, 31, 33, 34, 35, 73, 74, 81, 82, 83, 90, 91, 92, 99, 100, 101
Threshold“ · 124, 125, 134, 136, 150, 152, 153
Trapezoid“ · 120, 121, 134, 136, 145
Trigger“ · 111, 204

U

USB · 21, 23, 24, 37, 54, 57, 58, 59, 61, 176, 197, 199
User-defined values · 50, 51, 60, 61, 70, 173, 188, 192

W

Warranty · 2, 14