



OPERATION MANUAL

DIGIFORCE[®] 9311 EtherNet/IP manual

© 2018 burster
praezisionsmesstechnik gmbh & co kg
All rights reserved

Manufacturer:
burster
praezisionsmesstechnik gmbh & co kg
Talstraße 1 - 5 P.O.Box 1432
D-76593 Gernsbach D-76593 Gernsbach
Germany Germany

Valid from: **05.11.2018**

Tel.: (+49) 07224 645-0

Applies to: **DIGIFORCE[®] 9311**

Fax.: (+49) 07224 645-88
E-Mail: info@burster.com
www.burster.com

2811-BA9311EIEN-5170-111529

Warranty disclaimer

All information in the present documentation was prepared and compiled with great care and reproduced in accordance with effective control measures. This documentation may contain errors, and the information it contains and the corresponding technical data are subject to change without notice. Reproduction of any part of this documentation or its processing or revision using electronic systems is prohibited without the manufacturer's prior written approval.

Components, devices and measurement sensors made by burster praezisionsmesstechnik (hereinafter referred to as the "product") are the result of targeted development and meticulous research. From the date of delivery, burster provides a warranty for the proper condition and functioning of these products covering material and production defects for the period specified in the warranty document accompanying the product. However, burster waives any guarantee or warranty obligations or any additional liability for consequential damages caused by improper use of the product, in particular the implied guarantee of success in the market as well as the suitability of the product for a particular purpose. Furthermore, burster assumes no liability for direct, indirect or incidental damages or for consequential or other damages arising from the provision and use of the present documentation.



DECLARATION OF CONFORMITY

Declaration of Conformity (DOC) Reference Information		
File Number:	11535.02	Part 1 of 1 Year Last Issued: 2018
Length of Validity:	Continues in effect so long as the named entity (i) remains an ODVA Licensed Vendor for the ODVA technology(ies) defined by the above specification(s); (ii) continues to fulfill its user responsibilities as defined in its Terms of Usage Agreement with ODVA; and (iii) the CIP Identity for the Product(s) remains identical to those enumerated in this Declaration of Conformity.	

ODVA Licensed Vendor to Whom this DOC Has Been Issued		
Entity Name:	burster praezisionsmesstechnik gmbh & co kg	Vendor ID: 1381

Overview of Compliant Product(s) Covered by This DOC	
<small>(The list of product(s) covered by this DOC begins on page 2.)</small>	
Networks(s) Supported:	EtherNet/IP™
CIP Device Profile Supported:	Programmable Logic Controller
Classification of Declaration:	Single Product

Trademark(s) Approved for Use in the Labeling and Promotion of the Products Named Herein	
<small>(Color variations of logo marks allowed pursuant to ODVA Brand Standards+Identity Guidelines. No abbreviation of word marks allowed.)</small>	
Logo Marks	Word Marks
ODVA Certification Marks	
	ODVA CONFORMANT™
ODVA Technology Marks	
	EtherNet/IP™

This Declaration of Conformity, and approval of the use of ODVA's trademarks as shown above, has been granted by ODVA, Inc. based on its determination that the Product(s) identified herein fulfill(s) ODVA's standards for compliance with ODVA's specifications listed below at the ODVA composite Conformance Test (CT) level shown in parentheses:

The EtherNet/IP™ Specification (CT 13)

This Declaration of Conformity is issued on **October 18, 2018** on behalf of ODVA by:

 Katherine Voss, President

The list of product(s) covered by this DOC begins on page 2.

CIP Identity for Product(s) Covered Under this Declaration of Conformity (per CIP Identity Object)			
No.	Vendor Product Code (attribute 3)	Vendor Product Revision (attribute 4)	Vendor Product Name (attribute 7)
1	2	18.001	DIGIFORCE 9311-VXX04

Declaration of Conformity
File No.: 11535.02

Part 1 of 1 - page 2 of 2

© 2015 ODVA, Inc. The content of this Declaration of Conformity is public information and this Declaration may be reproduced in whole, but not in parts, without modification.



Table of contents

1	For your safety	8
1.1	Symbols used in the instruction manual.....	8
1.1.1	Signal words	8
1.1.2	Pictograms	8
1.2	Symbols and precautionary statements on the instrument.....	9
1.2.1	Conventions used in the instruction manual.....	9
1.3	Abbreviations.....	9
2	Introduction	10
2.1	General safety instructions.....	10
2.2	Intended use.....	11
3	Technical data	12
3.1	Supported EtherNet/IP-Services	12
3.2	Model 9311 device data	12
3.3	Electrical safety	12
3.4	Electromagnetic compatibility.....	13
3.4.1	Interference immunity	13
3.4.2	Emitted interference.....	13
3.5	Notes on CE labeling.....	13
4	Installation	14
4.1	Connection of fieldbus lines	14
4.2	Meaning of LEDs states	14
4.3	Configuration menu in DIGIFORCE [®] 9311	15
5	EtherNet/IP	17
5.1	General information on EtherNet/IP data transfer.....	17
5.2	EDS file	17
5.3	Data conversion	18
5.3.1	Description of the data formats in this manual	18
5.3.2	Handling problems that arise when reading floating-point numbers	18
6	EtherNet/IP data protocol (real-time data)	19
6.1	Meaning of the content of the cyclic data packet from adapter (DIGIFORCE [®]) to scanner	19
6.2	PLC inputs – Transfer from scanner to adapter (DIGIFORCE [®]).....	20
6.2.1	PLC inputs byte 1 - Scanner to adapter (DIGIFORCE [®])	20
6.2.2	PLC inputs byte 2 - Scanner to adapter (DIGIFORCE [®])	20
6.2.3	PLC inputs byte 3 - Scanner to adapter (DIGIFORCE [®])	21
6.3	PLC outputs – Transfer from adapter (DIGIFORCE [®]) to scanner	22
6.3.1	PLC outputs byte 1	22
6.3.2	PLC outputs byte 2	22

6.4	Evaluation info – Transfer from adapter (DIGIFORCE®) to scanner.....	24
6.4.1	Evaluation info byte 1	24
6.4.2	Evaluation info byte 2	24
6.5	Byte reference list.....	25
7	Unconnected Explicit Messaging (Acyclic services).....	29
7.1	Instrument configuration.....	29
7.1.1	General settings (Class 100)	29
7.1.2	Communication: Change menu, display update, fault indication (Class 101)	35
7.1.3	Program Selection/Renaming & Statistics reset (Class 102)	36
7.1.4	General channel settings (Class 103).....	36
7.1.5	Channel settings “Standard signal” (Class 104)	39
7.1.6	Channel settings “Strain gauge” (Class 105).....	39
7.1.7	Channel settings “Piezo” (Class 106)	40
7.1.8	Tare (Class 107)	40
7.1.9	Measurement mode (Class 108)	41
7.1.10	Evaluation window 1 (Class 109).....	43
7.1.11	Evaluation window 2 (Class 110).....	44
7.1.12	Evaluation window 3 (Class 111).....	45
7.1.13	Evaluation trapezoid window 1 (Class 112).....	45
7.1.14	Evaluation trapezoid window 2 (Class 113).....	47
7.1.15	Evaluation threshold 1 (Class 114).....	47
7.1.16	Evaluation threshold 2 (Class 115).....	49
7.1.17	Evaluation envelope (Class 116 to 120).....	49
7.1.18	Tolerance band for evaluation elements (Class 121).....	49
7.1.19	Realtime switchpoints S1 (Class 122)	49
7.1.20	Realtime switchpoints S2 (Class 123)	50
7.1.21	Realtime switchpoints S3 (Class 124)	50
7.1.22	Realtime switchpoints S4 (Class 125)	50
7.1.23	Realtime switchpoints S5 (Class 126)	51
7.1.24	Realtime switchpoints S6 (Class 127)	51
7.1.25	Sensortest (Class 128)	51
7.1.26	Setup user-defined values (Class 129).....	52
7.1.27	Copy/initialize measurement programs (Class 130).....	53
7.1.28	Reference curve (Class 131 to 133).....	54
7.1.29	Test operation (Class 134)	54
7.1.30	Zoom and autoscale (Class 135).....	54
7.1.31	USB-Logging (Class 136)	55
7.1.32	TEDS-Sensors (Class 137)	55
7.1.33	Reserved Classes (Classes 138... 148).....	55
7.2	Measurement results.....	56
7.2.1	Status of measurement (Class 149).....	56

7.2.2	Further information for current measurement curve (Class 150)	56
7.2.3	General curve data (Class 151).....	57
7.2.4	Request measurement results of user-defined values (Class 152).....	58
7.2.5	Read-out X-coordinates of current measurement curve (Class 153).....	62
7.2.6	Read-out Y-coordinates of current measurement curve (Class 154).....	64
7.2.7	Evaluation results window 1 (Class 155).....	64
7.2.8	Evaluation results window 2 (Class 156).....	65
7.2.9	Evaluation results window 3 (Class 157).....	65
7.2.10	Evaluation results threshold 1 (Class 158)	65
7.2.11	Evaluation results threshold 2 (Class 159).....	65
7.2.12	Evaluation results trapezoid window 1 (Class 160).....	66
7.2.13	Evaluation results trapezoid window 2 (Class 161).....	66
7.2.14	Evaluation results envelope (Class 162)	66
7.2.15	Combined results (common curve data and evaluation elements – Class 163)	67
8	Appendix	70
8.1	Operand table.....	70
9	Error Codes.....	74



1 For your safety

The following symbols on the DIGIFORCE® 9311 and in this operation manual warn of hazards.

1.1 Symbols used in the instruction manual

1.1.1 Signal words



The following signal words are used in the operation manual according to the specified hazard classification.

	DANGER
High degree of risk: indicates a hazardous situation which, if not avoided, will result in death or serious injury.	
	WARNING
Moderate degree of risk: indicates a hazardous situation which, if not avoided, may result in death or serious injury.	
	CAUTION
Low degree of risk: indicates a hazardous situation which, if not avoided, could result in minor or moderate injury.	
NOTICE	
Property damage to the equipment or the surroundings will result if the hazard is not avoided.	

Note: It is important to heed these safety notices in order to ensure you handle the DIGIFORCE® 9311 correctly.

Caution: Follow the information given in the operation manual.

1.1.2 Pictograms

Symbol	Description
	Warning concerning the use and installation of the device and software.
	Observe the advice for protecting the instrument.

1.2 Symbols and precautionary statements on the instrument

Symbol	Description
	Hazard warning Disconnect the power plug before opening – Follow safety instructions – Professional servicing only
Warning ! To prevent electrical shock do not open device.	Warning of electrical shock hazard Do not open the unit.
To prevent fire replace only with same type and rating of fuse !	Warning of fire hazard Always replace the fuse with a fuse of the same type and rating.

1.2.1 Conventions used in the instruction manual



Designation	Description
[Fx]	Function keys F1 to F3 on the touchscreen display
[Text]	Buttons on the touchscreen display
"Term"	Terms used in the instrument menus



1.3 Abbreviations

Abbreviation	Description
BF	Bus error
ODVA	ODVA is a trade and standards development organization, whose members are suppliers of devices for industrial automation application.
ESD	Electronic Data Sheet

2 Introduction

2.1 General safety instructions

	 <h2 style="margin: 0;">DANGER</h2>
	<p>Warning concerning installation of the device and software</p> <p>Installation of the device and the interface must be carried out by qualified personnel only. Qualified personnel meets the following requirements:</p> <ul style="list-style-type: none"> • You are familiar with the safety designs used in automation engineering, and understand how to deal with them in your capacity as configuration engineer. • You are an operator of automation systems and have been instructed in how to handle the system. You are familiar with the operation of the equipment described in this documentation. • You are a commissioning or service engineer and have successfully completed a training course qualifying you to repair automation systems. In addition you are authorized to commission, ground and label circuits and equipment in accordance with safety engineering standards. <p>Always observe the current safety and accident prevention regulations when commissioning the equipment. Install automation engineering equipment and installations with sufficient protection against accidental actuation.</p>

	 <h2 style="margin: 0;">DANGER</h2>
	<p>Warning concerning use of the device</p> <ul style="list-style-type: none"> • Take suitable precautions in both the hardware and software to prevent any undefined states of the automation installation in the event of an open circuit. • In installations where major damage to property or even personal injury may be caused by a malfunction, take suitable precautions to establish a safe operating state in the event of a fault. This may be achieved using limit switches, mechanical interlocks etc. for example. • Do not make unauthorized modifications to the device or to the EtherNet/IP interface.

	<h2 style="margin: 0;">NOTICE</h2>
	<ul style="list-style-type: none"> • Install the power, signal and sensor cables so as to prevent electromagnetic interference from impairing operation of the equipment. • Proper transportation, storage, installation and assembly plus careful operation and maintenance are essential for trouble-free and safe operation of the equipment. • Have non-functional instruments inspected by the manufacturer.

2.2 Intended use

The DIGIFORCE[®] 9311 is an instrument for monitoring repetitive production processes. Its core function is to record and analyze signals from processes in which physical variables, such as force, pressure or torque, vary as a function of displacement, angle or time according to a defined curve. The resultant measurement curve is analyzed using graphical evaluation elements such as windows, envelopes and thresholds. The result of the analysis is classified as "OK" or "NOT OK" (NOK) and can be retrieved from various interfaces.

The instrument is not a substitute for a safety device; for instance it cannot be used as an emergency stop device in a press for when the pressure exceeds a set limit.

3 Technical data

3.1 Supported EtherNet/IP-Services

- Implicit Messaging
- Explicit Messaging
- Vendor Specific Services (used for Device Configuration)
- Address Conflict Detection (ACD)
- Device Level Ring (DLR)

Identity Object of a sample device

Attribut	Wert
Vendor ID	0x565 (1381)
Device Type	0x2B (43)
Product Code	0x02 (2)
Major Revision	0x10 (16)
Minor Revision	0x01 (1)
Summary Status	0x60 (96)
Serial Number	123456
Product Name	DIGIFORCE 9311-VXX04
Present State	0x00 (0)

You will find further information about EtherNet/IP at: www.odva.org.

3.2 Model 9311 device data

Bus connector	RJ45
EDS file	BURSTER-DIGIFORCE-9311.EDS

3.3 Electrical safety

Reverse voltage protection	Yes
Air clearance/leakage paths	To DIN EN 61010-1:2010
Electrical isolation	Between fieldbus and internal electronics
Withstand voltage	DC 500 V

3.4 Electromagnetic compatibility

3.4.1 Interference immunity

Interference immunity to EN 61326-1:2013

Industrial locations

3.4.2 Emitted interference

Emitted interference to EN 61326-1:2013

Class A

EN 61000-3-2:2014

EN 61000-3-3:2013

3.5 Notes on CE labeling

burster equipment carrying the CE mark meets the requirements of the EU directives and the harmonized European standards (EN) cited therein.

The EU declarations of conformity are available to the relevant authorities as specified in the directives. A copy of the declaration of conformity is included in the relevant equipment documentation.

4 Installation

Please note that you can download various documents such as installation guidelines and specifications about EtherNet/IP at ODVA: www.odva.org.

4.1 Connection of fieldbus lines

burster devices with a EtherNet/IP option have two **RJ 45** connectors for the fieldbus connection.

4.2 Meaning of LEDs states



LED	Blinking	On	
ACT	Data transmission	x	
LNK / LA	x	Ethernet line monitoring	
MOD	Off	x	No power
	Green	Standby	Device operational
	Red	Minor fault Incorrect or inconsistent configuration	Major fault A non-recoverable fault
	Green/Red	Self-test	x
NET	Off	x	Not powered, no IP-Addr.
	Green	No connections	Device connected
	Red	Connection timeout	Duplicated IP
	Green/Red	Self-test	x
BF	x	x	
BOOT	Device in boot mode	x	
US1	x	Supply voltage	

4.3 Configuration menu in DIGIFORCE[®] 9311



To access the menu

Start in measurement mode. After power on the measurement mode is always set. The display will look differently dependent on your settings or your last measurements.

PROFINET settings for the DIGIFORCE[®] 9311 are configured via the "PROFINET" menu.



This is how it works

- 1 In measurement mode, tap anywhere on the touchscreen. The  icon appears in the bottom-right corner.
- 2 Tap  to open the "Configuration Main Menu".
- 3 Tap the "Basic setup" icon.
- 4 Tap the "EtherNet/IP" icon.

P 0	EtherNet/IP		M77
SW-version	EIP-V1601		
Serial number	01234567		
Control via	EtherNet/IP		
MAC address	00-23-6E-00-02-F9		
IP Configuration	DHCP		
IP address	169	254	044 011
Subnet mask	255	255	000 000
Gateway	000	000	000 000



Diagram 1: EtherNet/IP settings

Parameters in the "EtherNet/IP" menu (M77)

SW-version	Firmware version of the EtherNet/IP Fieldbus module
Serial number	Serial number of the Fieldbus module
Control via	<p>EtherNet/IP: the DIGIFORCE® 9311 responds solely to control signals (inputs) from the EtherNet/IP interface.</p> <p>PLC: the DIGIFORCE® 9311 responds solely to control signals (inputs) from the PLC I/O interface.</p> <p>When control via PLC I/O is selected, data is still transferred on the EtherNet/IP real-time channel.</p>
MAC address	Address for identifying the Fieldbus module in the EtherNet/IP network.
IP configuration	<p>Network configuration type (BOOTP, DHCP, static)</p> <p>Please note: this parameter cannot be changed in the DIGIFORCE® 9311.</p>
IP address	<p>IP address</p> <p>If BOOTP or DHCP is selected for "IP Configuration", the IP address is assigned by a BOOTP or DHCP server.</p> <p>Please note: the IP address cannot be changed by the user if BOOTP or DHCP is selected for the IP configuration mode.</p>
Subnet mask	<p>Subnet mask</p> <p>If BOOTP or DHCP is selected for "IP Configuration", the subnet mask is assigned by a BOOTP or DHCP server.</p> <p>Please note: the subnet mask cannot be changed by the user if BOOTP or DHCP is selected for the IP configuration mode.</p>
Gateway	<p>Gateway address</p> <p>If BOOTP or DHCP is selected for "IP Configuration", the gateway is assigned by a BOOTP or DHCP server.</p> <p>Please note: the gateway address cannot be changed by the user if BOOTP or DHCP is selected for the IP configuration mode.</p>

5 EtherNet/IP

5.1 General information on EtherNet/IP data transfer

For EtherNet/IP (implicit messaging) one must define at the configuration stage how many bytes are transferred between Controller (Scanner) and Device (Adapter) during each cyclic access.

The device is controlled using the data transferred from Controller (Scanner) to Device (Adapter). This data always consists of three bytes for the DIGIFORCE® 9311 unit. The function of these three bytes is explained in chapter 5.2 PLC inputs – Transfer from Scanner to Adapter (Digiforce).

The DIGIFORCE® 9311 sends cyclic 92 bytes to controller. This packet contains PLC status, evaluation information and 20 measurement values which are user selectable within the 9311 configuration and the live values of max. 2 active measurement channels.

5.2 EDS file

DIGIFORCE® equipment with the EtherNet/IP option is supplied with a CD. This disk includes the **E**lectronic **D**ata **S**heet (EDS) file *BURSTER-DIGIFORCE-9311.EDS*. This EDS file contains the EtherNet/IP configuration information for the DIGIFORCE 9311®.

The structure, contents and encoding of this device description data is standardized so that any EtherNet/IP devices can be configured using configuration tools from various manufacturers.

The EDS file does not specify what data is transferred or how this data should be interpreted. The user must glean this information from the operating manual and program his Controller accordingly.

5.3 Data conversion

5.3.1 Description of the data formats in this manual

The terms PLC inputs and PLC outputs refer to the DIGIFORCE® 9311 unit. These terms are reversed when referred to the Controller.

The function of the PLC-In / PLC-Out bits is identical to the parallel PLC I/O ports on the unit itself and can be found within the DIGIFORCE® 9311 operating manual.

The floating-point numbers ("float") mentioned are four bytes long (32 bits) and are based on the IEEE-754 standard.

Numbers that are not specifically labeled or are labeled with "d" or "dec" are decimal numbers. (Example: 1234, 1234dec, dec1234, 1234d)

Numbers that are labeled with "0x" or "hex" are hexadecimal numbers. (Example: 0x1234, hex1234, 1234hex, 1234h)

Numbers that are labeled with "b" or "bin" are binary numbers. (Example: b1100, bin1100, 1100b, 1100bin).

5.3.2 Handling problems that arise when reading floating-point numbers

This only concerns cases in which floating-point numbers need to be read from the DIGIFORCE® 9311 unit.

Floating-point numbers (data type REAL), according to IEEE 754, are encoded as four bytes for transfer. This may create problems depending on the type of PLC used.

Cause

In the DIGIFORCE® 9311-PROFINET, the sign byte is transferred first if using acyclic data transfer (see 6. Unconnected Explicit Messaging) and last while cyclic data transmission. Some PLCs expect this byte in the highest of the four addresses not in the lowest address. This inevitably leads to misinterpretation of the numeric value. In this case the order of the four bytes has to be changed by the PLC as shown in the figure.

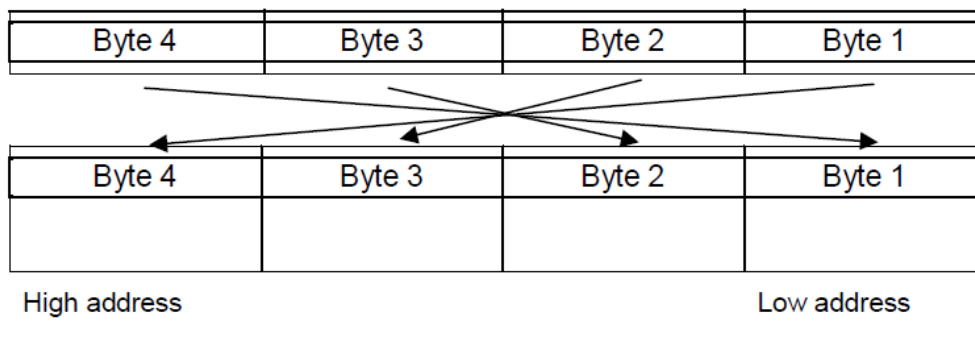

Diagram 2: Exchange of the order of bytes caused by misinterpretation of the numeric value

6 EtherNet/IP data protocol (real-time data)

6.1 Meaning of the content of the cyclic data packet from adapter (DIGIFORCE[®]) to scanner

Overview of the packet content:

Content	Length/Bytes	Bytes
PLC output status	2	Σ 92 bytes
Evaluation info	2	
20 evaluation values (float) , user-defined values*	20x4	
2 live values (X, Y) * ¹	2x4	

* The user-defined values contain values which are defined within the DIGIFORCE[®] 9311 device. The following values are available:

- General curve data
- Evaluation results of each evaluation element (e.g. window entry/exit window extended evaluation results like Min/Max window limits Xmin, Xmax, Ymin, Ymax threshold crossing point)

*¹ The live values of the sensor channels are updated at a rate of 100 Hz. The values are only updated when the DIGIFORCE[®] 9311 is ready to record measurements or is actively taking a measurement.

How to define the user-defined values: The parameterization of the list is done in the main setup menu "Setup user defined values" (Note that this setting is specific for each measurement program. For details refer to the DIGIFORCE[®] 9311 operation manual, section 6.3.8 User-defined values.)

6.2 PLC inputs – Transfer from scanner to adapter (DIGIFORCE®)

Three bytes of PLC-In data for the DIGIFORCE® 9311 are always transferred from the EtherNet/IP Controller (Scanner) to the DIGIFORCE® 9311. These bits have the same function as the parallel PLC inputs to the DIGIFORCE® 9311 unit. (See detailed documentation of these signals within the DIGIFORCE® 9311 operation manual, 6.1.3 PLC inputs).

6.2.1 PLC inputs byte 1 - Scanner to adapter (DIGIFORCE®)

PLC inputs Byte 1 - Scanner to adapter (DIGIFORCE®)		
Valid values:	Adjustable input #1 (Pin 4) Default: IN_TARE_X	Bit 0 LSB
	Adjustable input #2 (Pin 5) Default: IN_RES_STAT	Bit 1
Set reserved bits to '0'	Adjustable input #3 (Pin 6) Default: IN_STEST	Bit 2
	IN_STROBE	Bit 3
	IN_AUTO	Bit 4
	Reserved	Bit 5
	Reserved	Bit 6
	Reserved	Bit 7 MSB

6.2.2 PLC inputs byte 2 - Scanner to adapter (DIGIFORCE®)

PLC inputs Byte 2 - Scanner to adapter (DIGIFORCE®)		
Valid values:	IN_PROG0	Bit 0 LSB
	IN_PROG1	Bit 1
Set reserved bits to '0'	IN_PROG2	Bit 2
	IN_PROG3	Bit 3
	Reserved	Bit 4
	Reserved	Bit 5
	Reserved	Bit 6
	Reserved	Bit 7 MSB

6.2.3 PLC inputs byte 3 - Scanner to adapter (DIGIFORCE®)

PLC inputs Byte 3 - Scanner to adapter (DIGIFORCE®)		
Valid values:	IN_START	Bit 0 LSB
	Reserved	Bit 1
Set reserved bits to '0'	Reserved	Bit 2
	Reserved	Bit 3
	Reserved	Bit 4
	Reserved	Bit 5
	Reserved	Bit 6
	Reserved	Bit 7 MSB



NOTICE

Note that the adjustable PLC inputs (Pin 4, 5 and 6) can be assigned with different functions. The assignment can be changed within the DIGIFORCE® 9311 “Basic setup” menu (M18) under “Assignment of the PLC inputs” (for further information see DIGIFORCE® model 9311 operation manual chapter 6.1.3 “PLC inputs”).

6.3 PLC outputs – Transfer from adapter (DIGIFORCE®) to scanner

The data refers to the PLC output of the DIGIFORCE® 9311. The data described here is the data transferred from the DIGIFORCE® 9311 to the EtherNet/IP controller.

The function of the PLC-In / PLC-Out bits is identical to the parallel PLC I/O ports on the unit itself and can be found within the DIGIFORCE® 9311 operation manual for the unit. Also the signal timing is available within the DIGIFORCE® 9311 operation manual.

6.3.1 PLC outputs byte 1

PLC outputs Byte 1 - Adapter (DIGIFORCE®) to scanner		
Valid values:	OUT_READY	Bit 0 LSB
	OUT_OK	Bit 1
	OUT_NOK	Bit 2
	OUT_NOK_ONL	Bit 3
	OUT_S1	Bit 4
	OUT_S2	Bit 5
	Adjustable output #1 (Pin 20) Default: OUT_OK_STEST	Bit 6
	Adjustable output #6 (Pin 25) Default: OUT_MEAS_ACT	Bit 7 MSB

6.3.2 PLC outputs byte 2

PLC outputs Byte 2 - Adapter (DIGIFORCE®) to scanner		
Valid values:	Adjustable output #2 (Pin 21) Default: OUT_STROBE	Bit 0 LSB
	Adjustable output #3 (Pin 22) Default: OUT_PROG0	Bit 1
	Adjustable output #4 (Pin 23) Default: OUT_PROG1	Bit 2
	Adjustable output #5 (Pin 24) Default: OUT_PROG2	Bit 3
	Reserved	Bit 4
	Reserved	Bit 5
	Reserved	Bit 6
	Reserved	Bit 7 MSB



NOTICE

Note that PLC outputs [6..1] can be assigned with different functions. The assignment can be changed within the DIGIFORCE[®] 9311 “Basic setup” menu (M18) under “Assignment of the PLC outputs”(see DIGIFORCE[®] model 9311 operation manual chapter 6.1.2 “PLC outputs”).

6.4 Evaluation info – Transfer from adapter (DIGIFORCE®) to scanner

The evaluation info (2 bytes) contains the evaluation result of each element.

6.4.1 Evaluation info byte 1

Evaluation info byte 1 - Adapter (DIGIFORCE®) to scanner		
Valid values:	Global_NOK	Bit 0 LSB
	Overload_NOK	Bit 1
	Window_1_NOK	Bit 2
	Window_2_NOK	Bit 3
	Window_3_NOK	Bit 4
	Threshold_1_NOK	Bit 5
	Threshold_2_NOK	Bit 6
	Trapezoid_1_NOK	Bit 7 MSB

6.4.2 Evaluation info byte 2

Evaluation info byte 2 - Adapter (DIGIFORCE®) to scanner		
Valid values:	Trapezoid_2_NOK	Bit 0 LSB
	Envelope_NOK	Bit 1
	Measurement w/o READY	Bit 2
	USB logging error	Bit 3
	Reserved	Bit 4
	Reserved	Bit 5
	Reserved	Bit 6
	Reserved	Bit 7 MSB

6.5 Byte reference list

Data from scanner to adapter (DIGIFORCE[®])

Byte	Function	Section	Comments
0	PLC inputs Byte 1	6.2.1	
1	PLC inputs Byte 2	6.2.2	
2	PLC inputs Byte 3	6.2.3	

Data from adapter (DIGIFORCE[®]) to scanner

Byte	Function	Section	Comments
0	PLC outputs Byte 1	6.3.1	
1	PLC outputs Byte 2	6.3.2	
2	Evaluation info Byte 1	6.4.1	
3	Evaluation info Byte 2	6.4.2	
4	User-defined value_1 (1 st Byte)	see DIGIFORCE [®] 9311 operation manual 6.3.8 User defined values	User defined value in DIGIFORCE [®] 9311 (32-Bit float)
5	User-defined value_1 (2 nd Byte)	see above	
6	User-defined value_1 (3 rd Byte)	see above	
7	User-defined value_1 (4 th Byte)	see above	
8	User-defined value_2 (1 st Byte)	see above	User defined value in DIGIFORCE [®] 9311 (32-Bit float)
9	User-defined value_2 (2 nd Byte)	see above	
10	User-defined value_2 (3 rd Byte)	see above	
11	User-defined value_2 (4 th Byte)	see above	
12	User-defined value_3 (1 st Byte)	see above	User defined value in DIGIFORCE [®] 9311 (32-Bit float)
13	User-defined value_3 (2 nd Byte)	see above	
14	User-defined value_3 (3 rd Byte)	see above	
15	User-defined value_3 (4 th Byte)	see above	
16	User-defined value_4 (1 st Byte)	see above	User defined value in DIGIFORCE [®] 9311 (32-Bit float)
17	User-defined value_4 (2 nd Byte)	see above	
18	User-defined value_4 (3 rd Byte)	see above	
19	User-defined value_4 (4 th Byte)	see above	
20	User-defined value_5 (1 st Byte)	see above	User defined value in

Byte	Function	Section	Comments
21	User-defined value_5 (2nd Byte)	see above	DIGIFORCE® 9311 (32-Bit float)
22	User-defined value_5 (3rd Byte)	see above	
23	User-defined value_5 (4th Byte)	see above	
24	User-defined value_6 (1st Byte)	see above	User defined value in DIGIFORCE® 9311 (32-Bit float)
25	User-defined value_6 (2nd Byte)	see above	
26	User-defined value_6 (3rd Byte)	see above	
27	User-defined value_6 (4th Byte)	see above	
28	User-defined value_7 (1st Byte)	see above	User defined value in DIGIFORCE® 9311 (32-Bit float)
29	User-defined value_7 (2nd Byte)	see above	
30	User-defined value_7 (3rd Byte)	see above	
31	User-defined value_7 (4th Byte)	see above	
32	User-defined value_8 (1st Byte)	see above	User defined value in DIGIFORCE® 9311 (32-Bit float)
33	User-defined value_8 (2nd Byte)	see above	
34	User-defined value_8 (3rd Byte)	see above	
35	User-defined value_8 (4th Byte)	see above	
36	User-defined value_9 (1st Byte)	see above	User defined value in DIGIFORCE® 9311 (32-Bit float)
37	User-defined value_9 (2nd Byte)	see above	
38	User-defined value_9 (3rd Byte)	see above	
39	User-defined value_9 (4th Byte)	see above	
40	User-defined value_10 (1st Byte)	see above	User defined value in DIGIFORCE® 9311 (32-Bit float)
41	User-defined value_10 (2nd Byte)	see above	
42	User-defined value_10 (3rd Byte)	see above	
43	User-defined value_10 (4th Byte)	see above	
44	User-defined value_11 (1st Byte)	see above	User defined value in DIGIFORCE® 9311 (32-Bit float)
45	User-defined value_11 (2nd Byte)	see above	
46	User-defined value_11 (3rd Byte)	see above	
47	User-defined value_11 (4th Byte)	see above	
48	User-defined value_12 (1st Byte)	see above	User defined value in DIGIFORCE® 9311 (32-Bit float)
49	User-defined value_12 (2nd Byte)	see above	

Byte	Function	Section	Comments
50	User-defined value_12 (3rd Byte)	see above	
51	User-defined value_12 (4th Byte)	see above	
52	User-defined value_13 (1st Byte)	see above	User defined value in DIGIFORCE® 9311 (32-Bit float)
53	User-defined value_13 (2nd Byte)	see above	
54	User-defined value_13 (3rd Byte)	see above	
55	User-defined value_13 (4th Byte)	see above	
56	User-defined value_14 (1st Byte)	see above	User defined value in DIGIFORCE® 9311 (32-Bit float)
57	User-defined value_14 (2nd Byte)	see above	
58	User-defined value_14 (3rd Byte)	see above	
59	User-defined value_14 (4th Byte)	see above	
60	User-defined value_15 (1st Byte)	see above	User defined value in DIGIFORCE® 9311 (32-Bit float)
61	User-defined value_15 (2nd Byte)	see above	
62	User-defined value_15 (3rd Byte)	see above	
63	User-defined value_15 (4th Byte)	see above	
64	User-defined value_16 (1st Byte)	see above	User defined value in DIGIFORCE® 9311 (32-Bit float)
65	User-defined value_16 (2nd Byte)	see above	
66	User-defined value_16 (3rd Byte)	see above	
67	User-defined value_16 (4th Byte)	see above	
68	User-defined value_17 (1st Byte)	see above	User defined value in DIGIFORCE® 9311 (32-Bit float)
69	User-defined value_17 (2nd Byte)	see above	
70	User-defined value_17 (3rd Byte)	see above	
71	User-defined value_17 (4th Byte)	see above	
72	User-defined value_18 (1st Byte)	see above	User defined value in DIGIFORCE® 9311 (32-Bit float)
73	User-defined value_18 (2nd Byte)	see above	
74	User-defined value_18 (3rd Byte)	see above	
75	User-defined value_18 (4th Byte)	see above	
76	User-defined value_19 (1st Byte)	see above	User defined value in DIGIFORCE® 9311 (32-Bit float)
77	User-defined value_19 (2nd Byte)	see above	
78	User-defined value_19 (3rd Byte)	see above	

Byte	Function	Section	Comments
79	User-defined value_19 (4 th Byte)	see above	
80	User-defined value_20 (1 st Byte)	see above	User defined value in DIGIFORCE® 9311 (32-Bit float)
81	User-defined value_20 (2 nd Byte)	see above	
82	User-defined value_20 (3 rd Byte)	see above	
83	User-defined value_20 (4 th Byte)	see above	
84	Live value Channel X (1 st Byte)		
85	Live value Channel X (2 nd Byte)		
86	Live value Channel X (3 rd Byte)		
87	Live value Channel X (4 th Byte)		
88	Live value Channel Y (1 st Byte)		(32-Bit float) Channel Y live value Updating rate of the live values ¹⁰⁰ /sec.
89	Live value Channel Y (2 nd Byte)		
90	Live value Channel Y (3 rd Byte)		
91	Live value Channel Y (4 th Byte)		

7 Unconnected Explicit Messaging (Acyclic services)

The services are described from the point of view of the controller.

Note: The instance number has always to be set to 1.

The acyclic EtherNet/IP services allow access to following DIGIFORCE® 9311 functions:

- Complete device configuration
- Transfer of component/worker/job data for logging
- Retrieval of large amounts of process and curve data

7.1 Instrument configuration

7.1.1 General settings (Class 100)

Class 100, Attributes 0 to 18

Class	Attr.	Description	Value	Meaning of value	Type	Len	R/W
100	0		-	Not possible			X
100	1...9	Reserved	-	Not possible			X
100	10	Device detection	<i>DIGIFORCE model 9311</i>		STR18	18	RO
100	11	Serial number	<i>12345678</i>		STR11	11	RO
100	12	Software version	<i>V201600</i>		STR25	25	RO
100	13	Version boot loader software	<i>V201500</i>		STR25	25	RO
100	14	Software version Field bus interface	<i>PN-V201600</i>		STR25	25	RO
100	15	Optional analog interface enabled	<i>0 1 2 3</i>	Strain gauge+Potent. Piezo+Potentiometer Strain gauge+Increm. Piezo+Incremental	U16	2	RO
100	16	Info: Calibration date analog interface	<i>07.11.2016</i>		STR10	10	RO
100	17	Station name	<i>Stat14 right</i>		STR15	15	RW
100	18	reserved	-	-	-	-	-

Class 100, Attributes 19 to 35

Class	Attr.	Description	Value	Meaning of value	Type	Len	R/W
100	19	Language	0 1 2 3 4 5	German English French Spanish Italian Chinese	U16	2	RW
100	20	Date	[dd.mm.yyyy]	e.g.: 21.09.2016	STR10	10	RW
100	21	Time	[hh:mm:ss], 24h	e.g.: 16:15:00	STR8	8	RW
100	22	LCD brightness	1 ... 10	Integer value (10 max.)	U16	2	RW
100	23	Measurement menu function key definition F1	0 1 2 3 4 5 6 7 8 9	Off Meas. program incremental Meas. program decremental Tare X Tare Y Measurement Start/Stop Acknowledge OK parts Acknowledge NOK parts Sensor test Edit mode	U16	2	RW
100	24	Measurement menu function key definition F2	0 1 2 3 4 5 6 7 8 9	Off Meas. program incremental Meas. program decremental Tare X Tare Y Measurement Start/Stop Acknowledge OK parts Acknowledge NOK parts Sensor test Edit mode	U16	2	RW
100	25	Measurement menu function key definition F3	0 1 2 3 4 5 6 7 8 9	Off Meas. program incremental Meas. program decremental Tare X Tare Y Measurement Start/Stop Acknowledge OK parts Acknowledge NOK parts Sensor test Edit mode	U16	2	RW
100	26	Display mode of function Keys	0 1	Fade out Always on	U16	2	RW
100	27	Meas. menu display control GRAPHIC	0 1	Meas. menu disabled Meas. menu enabled	U16	2	RW
100	28	Meas. menu display control GENERAL CURVE	0 1	Meas. menu disabled Meas. menu enabled	U16	2	RW

Class	Attr.	Description	Value	Meaning of value	Type	Len	R/W
		DATA					
100	29	Meas. menu display control TOTAL (Off/Smiley/text)	0 1 2	Meas. menu disabled Smiley Text	U16	2	RW
100	30	Meas. menu display control ENTRY/EXIT VALUES	0 1	Meas. menu disabled Meas. menu enabled	U16	2	RW
100	31	Meas. menu display control USER DEFINED MEAS. VALUES	0 1	Meas. menu disabled Meas. menu enabled	U16	2	RW
100	32	Meas. menu display control STATISTICS	0 1	Meas. menu disabled Meas. menu enabled	U16	2	RW
100	33	Meas. menu display control ORDER SHEET	0 1	Meas. menu disabled Meas. menu enabled	U16	2	RW
100	34	Show/Hide of Live Values	0 1	Show Live Values Hide Live Values	U16	2	RW
100	35	Display the measurement menu, read the currently displayed measurement menu Note: The menu is selected here, but not yet displayed. Display only occurs through access to Class 100/68.	101 102 103 104 105 106 107	M1 Displaying meas. curves M2 General curve data M3 Total Result M4 Entry/Exit M5 User defined values M6 Statistics M7 Order sheet	U16	2	RW

Class 100, Attributes 36 to 51

Class	Attr.	Description	Value	Meaning of value	Type	Len	R/W
100	36	Access authorisation Password protection on/off	0 1	Password protection on Password protection off	U16	2	RW
100	37	Access authorisation BASIC SETUP MENU	0 1	Access level disabled Access level enabled	U16	2	RW
100	38	Access authorisation PROGRAM SELECTION	0 1	Access level disabled Access level enabled	U16	2	RW
100	39	Access authorisation COPY PROGRAMS	0 1	Access level disabled Access level enabled	U16	2	RW

Class	Attr.	Description	Value	Meaning of value	Type	Len	R/W
100	40	Access authorisation CURVE ANALYSIS	0	Access level disabled	U16	2	RW
			1	Access level enabled			
100	41	Access authorisation CHANNEL SETTINGS	0	Access level disabled	U16	2	RW
			1	Access level enabled			
100	42	Access authorisation MEASUREMENT MODE	0	Access level disabled	U16	2	RW
			1	Access level enabled			
100	43	Access authorisation EVALUATION	0	Access level disabled	U16	2	RW
			1	Access level enabled			
100	44	Access authorisation REALTIME SWITSCPOINTS	0	Access level disabled	U16	2	RW
			1	Access level enabled			
100	45	Access authorization TEST OPERATION	0	Access level disabled	U16	2	RW
			1	Access level enabled			
100	46	Access authorisation SENSOR TEST	0	Access level disabled	U16	2	RW
			1	Access level enabled			
100	47	Access authorisation USER DEFINED VALUES	0	Access level disabled	U16	2	RW
			1	Access level enabled			
100	48	Access authorisation EXTERNAL MEMORY	0	Access level disabled	U16	2	RW
			1	Access level enabled			
100	49	Master password	0000 ... 9999		U16	2	RW
100	50	Set Master password to default	EVENT!	Writing an arbitrary byte initiates action	U8	1	WO
100	51	User password	0000 ... 9999		U16	2	RW

Class 100, Attribute 52 (Assignment adjustable PLC output 1)

Class	Attr.	Description	Value	Meaning of value	Type	Len	R/W
100	52	adj. PLC output 1 (Pin 20)	0	OUT_OK_STEST	U16	2	RW
100	52	adj. PLC output 1 (Pin 20)	1	OUT_STROBE	U16	2	RW
100	52	adj. PLC output 1 (Pin 20)	2	OUT_PROG0	U16	2	RW
100	52	adj. PLC output 1 (Pin 20)	3	OUT_PROG1	U16	2	RW
100	52	adj. PLC output 1 (Pin 20)	4	OUT_PROG2	U16	2	RW
100	52	adj. PLC output 1 (Pin 20)	5	OUT_PROG3	U16	2	RW
100	52	adj. PLC output 1 (Pin 20)	6	OUT_MEAS_ACT	U16	2	RW
100	52	adj. PLC output 1 (Pin 20)	7	OUT_S3	U16	2	RW
100	52	adj. PLC output 1 (Pin 20)	8	OUT_S4	U16	2	RW
100	52	adj. PLC output 1 (Pin 20)	9	OUT_S5	U16	2	RW

Class	Attr.	Description	Value	Meaning of value	Type	Len	R/W
100	52	adj. PLC output 1 (Pin 20)	10	OUT_S6	U16	2	RW
100	52	adj. PLC output 1 (Pin 20)	11	OUT_TEST_OP	U16	2	RW
100	52	adj. PLC output 1 (Pin 20)	12	OUT_ERROR	U16	2	RW
100	52	adj. PLC output 1 (Pin 20)	13	OUT_WARN_TARE	U16	2	RW
100	52	adj. PLC output 1 (Pin 20)	14	OUT_CONFIG	U16	2	RW
100	52	adj. PLC output 1 (Pin 20)	15	OUT_ACK_ALARM	U16	2	RW
100	52	adj. PLC output 1 (Pin 20)	16	OUT_ACK_LOCK	U16	2	RW
100	52	adj. PLC output 1 (Pin 20)	17	OUT_ACK_OK	U16	2	RW
100	52	adj. PLC output 1 (Pin 20)	18	OUT_ACK_NOK	U16	2	RW
100	52	adj. PLC output 1 (Pin 20)	19	OUT_PC_LOG	U16	2	RW

Class 100, Attributes 53 to 57 (Assignment adjustable PLC outputs 2 to 6)

Class	Attr.	Description	Value	Meaning of value	Type	Len	R/W
100	53	adj. PLC output 2 (Pin 21)	<i>see index 52</i>		U16	2	RW
100	54	adj. PLC output 3 (Pin 22)	<i>see index 52</i>		U16	2	RW
100	55	adj. PLC output 4 (Pin 23)	<i>see index 52</i>		U16	2	RW
100	56	adj. PLC output 5 (Pin 24)	<i>see index 52</i>		U16	2	RW
100	57	adj. PLC output 6 (Pin 25)	<i>see index 52</i>		U16	2	RW

Class 100, Attribute 58 (Assignment adjustable PLC input 1)

Class	Attr.	Description	Value	Meaning of value	Type	Len	R/W
100	58	adj. PLC input 1 (Pin 4)	0	IN_TARE_X	U16	2	RW
100	58	adj. PLC input 1 (Pin 4)	1	IN_TARE_Y	U16	2	RW
100	58	adj. PLC input 1 (Pin 4)	2	IN_TARE_X+Y	U16	2	RW
100	58	adj. PLC input 1 (Pin 4)	3	IN_RES_STAT	U16	2	RW
100	58	adj. PLC input 1 (Pin 4)	4	IN_STEST	U16	2	RW
100	58	adj. PLC input 1 (Pin 4)	5	IN_TEST_OP	U16	2	RW
100	58	adj. PLC input 1 (Pin 4)	6	IN_ACK	U16	2	RW
100	58	adj. PLC input 1 (Pin 4)	7	IN_ACK_OK	U16	2	RW

Class	Attr.	Description	Value	Meaning of value	Type	Len	R/W
100	58	adj. PLC input 1 (Pin 4)	8	IN_ACK_NOK	U16	2	RW
100	58	adj. PLC input 1 (Pin 4)	9	IN_ACK_ERROR	U16	2	RW

Class 100, Attributes 59 to 60 (Assignment PLC inputs 2 to 3)

Class	Attr.	Description	Value	Meaning of value	Type	Len	R/W
100	59	adj. PLC input 2 (Pin 5)	<i>see index 58</i>		U16	2	RW
100	60	adj. PLC input 3 (Pin 6)	<i>see index 58</i>		U16	2	RW

Class 100, Attributes 61 to 71

Class	Attr.	Description	Value	Meaning of value	Type	Len	R/W
100	61	Order sheet: Operator	<i>Michael_Mueller</i>		STR 64	64	RW
100	62	Order sheet: Order number	<i>AN_123456</i>		STR 64	64	RW
100	63	Order sheet: Batch	<i>BATCH_257-3</i>		STR 64	64	RW
100	64	Order sheet: Component	<i>Cylinder_right</i>		STR 64	64	RW
100	65	Order sheet: Serial number 1	<i>SN_123456789</i>		STR 64	64	RW
100	66	Order sheet: Serial number 2	<i>SN_987654321</i>		STR 64	64	RW
100	67	Acknowledgement function on/off	0 1	Acknowledgement function off Acknowledgement function on	U16	2	RW
100	68	Acknowledgement function: Acknowledge OK parts on/off	0 1	Not active User has to confirm OK parts (F-Key or PLC input)	U16	2	RW
100	69	Acknowledgement function: Acknowledge NOK parts on/off	0 1	Not active User has to confirm NOK parts (F-Key or PLC input)	U16	2	RW
100	70	Acknowledgement function: Buzzer volume	0 ... 10	10: max. volume	U16	2	RW
100	71	Update display (refresh view)	<i>Event!</i>	Writing an arbitrary byte initiates action	U8	1	WO

7.1.2 Communication: Change menu, display update, fault indication (Class 101)

Class	Attr.	Description	Value	Meaning of value	Type	Len	R/W
101	0	Not possible	-	-	x	x	x
101	1 - 9	Reserved	-	-	x	x	x
101	10	Go to menu	0 1	Meas. Menu Graphical test menu	U16	2	WO
101	11	Initiate update of the LCD display	EVENT!	Writing an arbitrary byte initiates action	U8	1	WO
101	12	Device fault status	0x00000001	PREFIX addressing fault	U32	4	RO
			0x00000002	Enquiry received in Device mode	U32	4	RO
			0x00000004	Blockcheck error	U32	4	RO
			0x00000008	Command fault	U32	4	RO
			0x00000010	Parameter error	U32	4	RO
			0x00000020	Timeout Receive Timer	U32	4	RO
			0x00000040	Timeout Response Timer	U32	4	RO
			0x00000080	Invalid ! or ?	U32	4	RO
			0x00000100	Invalid configuration	U32	4	RO
			0x00000400	No valid measurements are available	U32	4	RO
			0x00004000	Reading out the measurement curve was interrupted by the beginning of a new measurement	U32	4	RO
			0x00080000	No TEDS or TEDS is not valid	U32	4	RO
			0x00100000	TEDS voltage too low	U32	4	RO
			0x00200000	TEDS ID not valid	U32	4	RO
			0x00400000	TEDS Version not valid	U32	4	RO
			0x00800000	Strain gauge sensor connected but another sensor selected	U32	4	RO
			0x01000000	Standard signal sensor connected but another sensor selected	U32	4	RO
			0x02000000	Unknown error	U32	4	RO
			0x04000000	Sensor type is not valid	U32	4	RO
			0x08000000	Potentiometer sensor connected but another sensor selected	U32	4	RO
			0x10000000	Direction of strain gauge is not valid	U32	4	RO

Class	Attr.	Description	Value	Meaning of value	Type	Len	R/W
			0x20000000	USB Flash Error	U32	4	RO

7.1.3 Program Selection/Renaming & Statistics reset (Class 102)

Class	Attr.	Description	Value	Meaning of value	Type	Len	R/W
102	0	Not possible	-	-	x	x	x
102	1 - 9	Reserved	-	-	x	x	x
102	10	Set program number	0 ... 15		U16	2	RW
102	11	Writing/Reading of the current program name	Program name		STR 20	20	RW
102	12	Reset statistics of a measurement program	0 ... 15	EVENT! Selection through writing the program number	U16	2	WO
102	13	Reset statistics in all measurement programs	EVENT!	Writing an arbitrary byte initiates action	U8	1	WO

7.1.4 General channel settings (Class 103)

Class	Attr.	Description	Value	Meaning of value	Type	Len	R/W
103	0	Not possible	-	-			X
103	1 - 9	Reserved	-	-			X
103	10	Channel settings channel X Note: First make the settings in Attributes 10, 11 then initiate with index 12!	0 1 2 3 4 5	Terminals: A, Potentiometer A, standard signal B, strain gauge B, standard signal B, Piezo Time	U16	2	RW
103	11	Channel settings channel Y Note: First make the settings in Attributes 10, 11 then initiate with index 12!	0 1 2 3 4 5	Terminals: A, Potentiometer A, standard signal B, strain gauge B, standard signal B, Piezo Time	U16	2	RW
103	12	Accept channel settings	Event!	The settings from Attributes 10, 11 are being stored. Writing an arbitrary byte initiates action.	U8	1	WO
103	13	Filter channel X Note: Not available for the channel settings "Piezo"	0 1 2 3 4 5 6 7	Off 5 Hz filter 10 Hz filter 25 Hz filter 50 Hz filter 100 Hz filter 200 Hz filter 400 Hz filter	U16	2	RW

Class	Attr.	Description	Value	Meaning of value	Type	Len	R/W
			8	800 Hz filter			
103	14	Filter channel Y Notes: Not available for the channel settings "Piezo"	0 1 2 3 4 5 6 7 8	Off 5 Hz filter 10 Hz filter 25 Hz filter 50 Hz filter 100 Hz filter 200 Hz filter 400 Hz filter 800 Hz filter	U16	2	RW
103	15	Transmitter supply channel X Note: Entry is not available for the channel settings "Piezo" Only for 'BlackBox' devices	0 1	Transmitter supply off Transmitter supply on	U16	2	RW
103	16	Transmitter supply channel Y Note: Entry is not available for the channel settings "Piezo" Only for 'BlackBox' devices	0 1	Transmitter supply off Transmitter supply on	U16	2	RW
103	17	Set unit channel X Note: Entry is not available for the channel settings "Time"	0 1 2 3 4 5 6 7 8 9 10 11 12	User defined unit 1 User defined unit 2 User defined unit 3 mm N kN Nm Ncm grd bar V s ms	U16	2	RW
103	18	Set unit channel Y Note: Entry is not available for the channel settings "Time"	0 1 2 3 4 5 6 7 8 9	User defined unit 1 User defined unit 2 User defined unit 3 mm N kN Nm Ncm grd bar	U16	2	RW

Class	Attr.	Description	Value	Meaning of value	Type	Len	R/W
			10 11 12	V s ms			
103	19	Set user defined unit 1	<i>abcd</i>		STR 4	4	RW
103	20	Set user defined unit 2	<i>abcd</i>		STR 4	4	RW
103	21	Set user defined unit 3	<i>ijkl</i>		STR 4	4	RW
103	22	Returns the measured value on channel X Note: Entry is not available for the channel settings "Time"	<i>EVENT!</i>		FLT	4	RO
103	23	Returns the measured value on channel Y Note: Entry is not available for the channel settings "Time"	<i>EVENT!</i>		FLT	4	RO
103	24	Channel to be scaled	0 1	Channel X Channel Y	U 16	2	WO
103	25	Lower scale value		Concerns the channel selected under index 24	FLT	4	RW
103	26	Upper scale value		Concerns the channel selected under index 24	FLT	4	RW
103	27	Lower calibration value		Concerns the channel selected under index 24	FLT	4	RW
103	28	Upper calibration value		Concerns the channel selected under index 24	FLT	4	RW
103	29	Perform scaling (as per index 25 ... 29)	<i>EVENT</i>	Entry is not available for the channel settings "Off" and "Time"	U8	1	WO
103	30	Switch between program depending and global channel settings	0 1	Program depending Global Note: If changing to global settings, the individual channel setting will get lost	U 16	2	RW

7.1.5 Channel settings “Standard signal” (Class 104)

Class	Attr.	Description	Value	Meaning of value	Type	Len	R/W
104	0	Not possible	-	-			X
104	1 - 9	Reserved	-	-			X
104	10	Standard signal input channel X	0 1	5 V input range 10 V input range	U16	2	RW
104	11	Standard signal input channel Y	0 1	5 V input range 10 V input range	U16	2	RW

7.1.6 Channel settings “Strain gauge” (Class 105)

Class	Attr.	Description	Value	Meaning of value	Type	Len	R/W
105	0	Not possible	-	-			X
105	1 - 9	Reserved	-	-			X
105	10	Strain gauge input range channel X	0 1 2 3 4	2 mV/V input range 4 mV/V input range 10 mV/V input range 20 mV/V input range 40 mV/V input range	U16	2	RW
105	11	Strain gauge input range channel Y	0 1 2 3 4	2 mV/V input range 4 mV/V input range 10 mV/V input range 20 mV/V input range 40 mV/V input range	U16	2	RW
105	12	Strain gauge sensitivity channel X	0.01 ... 100.0	IEEE754 Float	FLT	4	RW
105	13	Strain gauge sensitivity channel Y	0.01 ... 100.0	IEEE754 Float	FLT	4	RW
105	14	Level (elect.) strain gauge channel X	0.01 ... 100.0	IEEE754 Float	FLT	4	RO
105	15	Level (elect.) strain gauge channel Y	0.01 ... 100.0	IEEE754 Float	FLT	4	RO

7.1.7 Channel settings “Piezo” (Class 106)

Class	Attr.	Description	Value	Meaning of value	Type	Len	R/W
106	0	Not possible	-	-			X
106	1 - 9	Reserved	-	-			X
106	10	Piezo input range channel X	0 1 2 3 4 5 6 7 8 9	1nC range 2nC range 5nC range 10nC range 20nC range 40nC range 80nC range 200nC range 400nC range 1uC range	U16	2	RW
106	11	Piezo input range channel Y	0 1 2 3 4 5 6 7 8 9	1nC range 2nC range 5nC range 10nC range 20nC range 40nC range 80nC range 200nC range 400nC range 1uC range	U16	2	RW
106	12	Piezo short-circuit on/to channel X	0 1	Do not short-circuit piezo input Short-circuit piezo input	U16	2	WO
106	13	Piezo short-circuit on/to channel Y	0 1	Do not short-circuit piezo input Short-circuit piezo input	U16	2	WO

7.1.8 Tare (Class 107)

Class	Attr.	Description	Value	Meaning of value	Type	Len	R/W
107	0	Not possible	-	-			X
107	1...9	Reserved	-	-			X
107	10	Tare at meas. start channel X	0 1	off on	U16	2	RW
107	11	Tare at meas. start channel Y	0 1	off on	U16	2	RW
107	12	Standard value for tare channel X	<i>between -9999999.0 and 9999999.0</i>	Float value, Float according to IEEE754	FLT	4	RW
107	13	Standard value for tare channel Y	<i>between -9999999.0 and 9999999.0</i>	Float value, Float according to IEEE754	FLT	4	RW
107	14	Tare warning on/off channel X	0 1	off on	U16	2	RW

Class	Attr.	Description	Value	Meaning of value	Type	Len	R/W
107	15	Tare warning on/off channel Y	0 1	off on	U16	2	RW
107	16	Set tare warning limit channel X	between 1.0 and 20.0	Float value, Float according to IEEE754	FLT	4	RW
107	17	Set tare warning limit channel Y	between 1.0 and 20.0	Float value Float according to IEEE754	FLT	4	RW
107	18	Tare channel X	EVENT!	Writing an arbitrary byte initiates action	U8	1	WO
107	19	Delete tare channel X	EVENT!	Writing an arbitrary byte initiates action	U8	1	WO
107	20	Tare channel Y	EVENT!	Writing an arbitrary byte initiates action	U8	1	WO
107	21	Delete tare channel Y	EVENT!	Writing an arbitrary byte initiates action	U8	1	WO

7.1.9 Measurement mode (Class 108)

Class	Attr.	Description	Value	Meaning of value	Type	Len	R/W
108	0	Not possible	-	-			X
108	1...9	Reserved	-	-			X
108	10	X sampling off/on	0 1	off on	U16	2	RW
108	11	X sample rate	between 0.0 and 9999999.0	Float value Float according to IEEE754	FLT	4	RW
108	12	Y sampling off/on	0 1	off on	U16	2	RW
108	13	Y sample rate	between 0.0 and 9999999.0	Float value Float according to IEEE754	FLT	4	RW
108	14	Time sampling off/on	0 1	off on	U16	2	RW
108	15	Time sample rate	between 0.0 and 9999999.0	Float value Float according to IEEE754	FLT	4	RW
108	16	Set reference of curve Note: "Underrun" is not permitted if the channel concerned is set to time.	0 1 2 3 4 5	Absolute Final force Y reference line overrun Y reference line underrun Y trigger overrun Y trigger underrun	U16	2	RW
108	17	Set reference line Y	between -9999999.0 and 9999999.0	Float value Float according to IEEE754	FLT	4	RW
108	18	Set trigger line Y	between -9999999.0 and 9999999.0	Float value Float according to IEEE754	FLT	4	RW

Class	Attr.	Description	Value	Meaning of value	Type	Len	R/W
108	19	Set return point	0 1 2 3	XMIN XMAX YMIN YMAX	U16	2	RW
108	20	Set "Record curve to"	0 1	Complete curve Up to return point	U16	2	RW
108	21	Set start mode	0 1 2 3 4	External X internal overrun X internal underrun Y internal overrun Y internal underrun	U16	2	RW
108	22	Set stop mode	0 1 2 3 4 5 6	External X internal overrun X internal underrun Y internal overrun Y internal underrun Timeout Defined number of measured values	U16	2	RW
108	23	Set X start value for internal start	<i>between -9999999.0 and 9999999.0</i>	Float value Float according to IEEE754	FLT	4	RW
108	24	Set Y start value for internal start	<i>between -9999999.0 and 9999999.0</i>	Float value Float according to IEEE754	FLT	4	RW
108	25	Set X stop value for internal stop	<i>between -9999999.0 and 9999999.0</i>	Float value Float according to IEEE754	FLT	4	RW
108	26	Set Y stop value for internal stop	<i>between -9999999.0 and 9999999.0</i>	Float value Float according to IEEE754	FLT	4	RW
108	27	Set the "stop" timeout value	<i>between 0 and 9999999.0</i>	Float value Float according to IEEE754	FLT	4	RW
108	28	Set the "stop" number of measured values	<i>0 bis 5000</i>	Integer value	U16	2	RW

7.1.10 Evaluation window 1 (Class 109)

Class	Attr.	Description	Value	Meaning of value	Type	Len	R/W
109	0	Not possible	-	-			X
109	1...9	Reserved	-	-			X
109	10	Window 1 off/on	0 1	off on	U16	2	RW
109	11	Window 1 limit Xmin Note: At the end, entry must be adopted through index 15.	between -9999999.0 and 9999999.0	Float value Float according to IEEE754	FLT	4	RW
109	12	Window 1 limit Xmax Note: At the end, entry must be adopted through index 15.	between -9999999.0 and 9999999.0	Float value Float according to IEEE754	FLT	4	RW
109	13	Window 1 limit Ymin Note: At the end, entry must be adopted through index 15.	between -9999999.0 and 9999999.0	Float value Float according to IEEE754	FLT	4	RW
109	14	Window 1 limit Ymax Note: At the end, entry must be adopted through index 15.	between -9999999.0 and 9999999.0	Float value Float according to IEEE754	FLT	4	RW
109	15	Window 1 copy limit Note: Values entered into Attributes 11, 12, 13, 14 are adopted	EVENT!	Writing an arbitrary byte initiates action	U8	1	WO
109	16	Window 1 entry left Note: At the end, entry must be adopted through index 24.	0 1	no yes	U16	2	RW
109	17	Window 1 entry right Note: At the end, entry must be adopted through index 24.	0 1	no yes	U16	2	RW
109	18	Window 1 entry bottom Note: At the end, entry must be adopted through index 24.	0 1	no yes	U16	2	RW
109	19	Window 1 entry top Note: At the end, entry must be adopted through index 24.	0 1	no yes	U16	2	RW

Class	Attr.	Description	Value	Meaning of value	Type	Len	R/W
109	20	Window 1 exit left Note: At the end, entry must be adopted through index 24.	0 1	no yes	U16	2	RW
109	21	Window 1 exit right Note: At the end, entry must be adopted through index 24.	0 1	no yes	U16	2	RW
109	22	Window 1 exit bottom Note: At the end, entry must be adopted through index 24.	0 1	no yes	U16	2	RW
109	23	Window 1 exit top Note: At the end, entry must be adopted through index 24.	0 1	no yes	U16	2	RW
109	24	Copy window entry/exit Note: Values entered into Attributes 16 - 23 are adopted	<i>EVENT!</i>	no yes	U8	1	WO
109	25	Window 1 curve segment for evaluation	0 1 2	Forward Return Complete curve	U16	2	RW
109	26	Window 1 online evaluation	0 1 2 3 4	Off left - right right - left bottom - top top - bottom	U16	2	RW
109	27	Window 1 Online signal level	0 1	Low active High active	U16	2	RW

7.1.11 Evaluation window 2 (Class 110)

Class	Attr.	Description	Value	Meaning of value	Type	Len	R/W
110	0	Not possible	-	-			X
110	1...9	Reserved	-	-			X
110	10 ...	See Class 109					

7.1.12 Evaluation window 3 (Class 111)

Class	Attr.	Description	Value	Meaning of value	Type	Len	R/W
111	0	Not possible	-	-			X
111	1...9	Reserved	-	-			X
111	10 ...	See Class 109					

7.1.13 Evaluation trapezoid window 1 (Class 112)

Class	Attr.	Description	Value	Meaning of value	Type	Len	R/W
112	0	Not possible	-	-			X
112	1...9	Reserved	-	-			X
112	10	Trapezoid 1 off/on	0 1	off on	U16	2	RW
112	11	Trapezoid type X/Y	0 1	Type X-Trapezoid Type Y-Trapezoid			
112	12	Trapezoid 1 limit Type X: Xmin Type Y: Ymin Note: At the end, entry must be adopted through index 18	between -9999999.0 and 9999999.0	Float value Float according to IEEE754	FLT	4	RW
112	13	Trapezoid 1 limit Type X: Xmax Type Y: Ymax Note: At the end, entry must be adopted through index 18	between -9999999.0 and 9999999.0	Float value Float according to IEEE754	FLT	4	RW
112	14	Trapezoid 1 limit Type X: Ymin left Type Y: Xmin bottom Note: At the end, entry must be adopted through index 18	between -9999999.0 and 9999999.0	Float value Float according to IEEE754	FLT	4	RW
112	15	Trapezoid 1 limit Type X: Ymax left Type Y: Xmax bottom	between -9999999.0 and 9999999.0	Float value Float according to IEEE754	FLT	4	RW

Class	Attr.	Description	Value	Meaning of value	Type	Len	R/W
		Note: At the end, entry must be adopted through index 18					
112	16	Trapezoid 1 limit Type X: Ymin right Type Y: Xmin top Note: At the end, entry must be adopted through index 18	<i>between -9999999.0 and 9999999.0</i>	Float value Float according to IEEE754	FLT	4	RW
112	17	Trapezoid 1 limit Type X: Ymax right Type Y: Xmax top Note: At the end, entry must be adopted through index 18	<i>between -9999999.0 and 9999999.0</i>	Float value Float according to IEEE754	FLT	4	RW
112	18	Trapezoid 1 copy the limits Note: Values entered into Attributes 12 - 17 are adopted	<i>EVENT</i>	Writing an arbitrary byte initiates action	U8	1	WO
112	19	Trapezoid 1 entry Type X: entry left Type Y: entry bottom Note: At the end, entry must be adopted through index 23	0 1	no yes	U16	2	RW
112	20	Trapezoid 1 entry Type X: entry right Type Y: entry top Note: At the end, entry must be adopted through index 23	0 1	no yes	U16	2	RW
112	21	Trapezoid 1 exit Type X: exit left Type Y: exit bottom Note: At the end,	0 1	no yes	U16	2	RW

Class	Attr.	Description	Value	Meaning of value	Type	Len	R/W
		entry must be adopted through index 23					
112	22	Trapezoid 1 exit Type X: exit right Type Y: exit top Note: At the end, entry must be adopted through index 23	0 1	no yes	U16	2	RW
112	23	Trapezoid 1 copy entry/exit Note: Values entered into Attributes 19- 22 are adopted.	<i>EVENT</i>	Writing an arbitrary byte initiates action	U8	1	WO
112	24	Trapezoid 1 curve segment for evaluation	0 1 2	Forward Return Complete curve	U16	2	RW

7.1.14 Evaluation trapezoid window 2 (Class 113)

Class	Attr.	Description	Value	Meaning of value	Type	Len	R/W
113	0	Not possible	-	-			X
113	1...9	Reserved	-	-			X
113	10 ...	See Class 112					

7.1.15 Evaluation threshold 1 (Class 114)

Class	Attr.	Description	Value	Meaning of value	Type	Len	R/W
114	0	Not possible	-	-			X
114	1...9	Reserved	-	-			X
114	10	Threshold 1 off/on	0 1	off on	U16	2	RW
114	11	Threshold 1 type of threshold	0 1	Type X (vertical) Type Y (horizontal)	U16	2	RW
114	12	Threshold 1 position Type X: X value Type Y: Y value Note: At the end, entry must be adopted through index 15.	<i>between -9999999.0 and 9999999.0</i>	Float value Float according to IEEE754	FLT	4	RW
114	13	Threshold 1 limit	<i>between -9999999.0</i>	Float value Float according to IEEE754	FLT	4	RW

Class	Attr.	Description	Value	Meaning of value	Type	Len	R/W
		Type X: Ymin Type Y: Xmin Note: At the end, entry must be adopted through index 15.	<i>and</i> 9999999.0				
114	14	Threshold 1 limit Type X: Ymax Type Y: Xmax Note: At the end, entry must be adopted through index 15.	<i>between</i> -9999999.0 <i>and</i> 9999999.0	Float value Float according to IEEE754	FLT	4	RW
114	15	Threshold 1 copy position and limits Note: Values entered into Attributes 11 - 14 are adopted	EVENT	Writing an arbitrary byte initiates action	U8	1	WO
114	16	Threshold 1 passage Type X: left > right Type Y: bottom > top Note: At the end, entry must be adopted through index 18.	0 1	no yes	U16	2	RW
114	17	Threshold 1 passage Type X: right > left Type Y: top > bottom Note: At the end, entry must be adopted through index 18.	0 1	no yes	U16	2	RW
114	18	Threshold 1 Copy passage Note: Values entered into Attributes 16 - 17 are adopted	EVENT	Writing an arbitrary byte initiates action	U8	1	WO
114	19	Threshold 1 Curve segment for evaluation	0 1 2	Forward Return Complete curve	U16	2	RW

7.1.16 Evaluation threshold 2 (Class 115)

Class	Attr.	Description	Value	Meaning of value	Type	Len	R/W
115	0	Not possible	-	-			X
115	1...9	Reserved	-	-			X
115	10 ...	See Class 114					

7.1.17 Evaluation envelope (Class 116 to 120)

Class/index data on request

7.1.18 Tolerance band for evaluation elements (Class 121)

Class	Attr.	Description	Value	Meaning of value	Type	Len	R/W
121	0	Not possible	-	-			X
121	1...9	Reserved	-	-			X
121	10	Tolerance band X Note: At the end, entry must be adopted through index 12.	<i>between 0.0 and 9999999.0</i>	Float value Float according to IEEE754	FLT	4	RW
121	11	Tolerance band Y Note: At the end, entry must be adopted through index 12.	<i>between 0.0 and 9999999.0</i>	Float value Float according to IEEE754	FLT	4	RW
121	12	Store tolerance bands Note: Values entered into Attributes 10 - 11 are adopted.	<i>EVENT</i>	Writing an arbitrary byte initiates action	U8	1	WO

7.1.19 Realtime switchpoints S1 (Class 122)

Class	Attr.	Description	Value	Meaning of value	Type	Len	R/W
122	0	Not possible	-	-			X
122	1...9	Reserved	-	-			X
122	10	Switchpoint S1 value Note: At the end, entry must be adopted through index 14.	<i>between -9999999.0 and 9999999.0</i>	Float value Float according to IEEE754	FLT	4	RW
122	11	Switchpoint S1 channel Note: At the end, entry must be adopted through index 14.	<i>0 1</i>	Channel X Channel Y	U16	2	RW

Class	Attr.	Description	Value	Meaning of value	Type	Len	R/W
122	12	Switchpoint S1 level Note: At the end, entry must be adopted through index 14.	0 1	Low active High active	U16	2	RW
122	13	Switchpoint 1 reference Note: At the end, entry must be adopted through index 14.	0 1	Absolute reference Trigger reference	U16	2	RW
122	14	Switchpoint 1 Copy settings Note: Values entered into Attributes 10 - 13 are adopted.	EVENT	Writing an arbitrary byte initiates action	U8	1	WO

7.1.20 Realtime switchpoints S2 (Class 123)

Class	Attr.	Description	Value	Meaning of value	Type	Len	R/W
123	0	Not possible	-	-			X
123	1...9	Reserved	-	-			X
123	10..	See Class 122					

7.1.21 Realtime switchpoints S3 (Class 124)

Class	Attr.	Description	Value	Meaning of value	Type	Len	R/W
124	0	Not possible	-	-			X
124	1...9	Reserved	-	-			X
124	10..	See Class 122					

7.1.22 Realtime switchpoints S4 (Class 125)

Class	Attr.	Description	Value	Meaning of value	Type	Len	R/W
125	0	Not possible	-	-			X
125	1...9	Reserved	-	-			X
125	10..	See Class 122					

7.1.23 Realtime switchpoints S5 (Class 126)

Class	Attr.	Description	Value	Meaning of value	Type	Len	R/W
126	0	Not possible	-	-			X
126	1...9	Reserved	-	-			X
126	10..	See Class 122					

7.1.24 Realtime switchpoints S6 (Class 127)

Class	Attr.	Description	Value	Meaning of value	Type	Len	R/W
127	0	Not possible	-	-			X
127	1...9	Reserved	-	-			X
127	10..	See Class 122					

7.1.25 Sensortest (Class 128)

Class	Attr.	Description	Value	Meaning of value	Type	Len	R/W
128	0	Not possible	-	-			X
128	1...9	Reserved	-	-			X
128	10	Sensor test Channel X on/off	0 1	off on	U16	2	RW
128	11	Sensor test Channel Y on/off	0 1	off on	U16	2	RW
128	12	Sensor test Channel X measure reference value	<i>EVENT</i>	Writing an arbitrary byte initiates action	U8	1	WO
128	13	Sensor test Channel Y measure reference value	<i>EVENT</i>	Writing an arbitrary byte initiates action	U8	1	WO
128	14	Sensor test Channel X reference value	<i>between -9999999.0 and 9999999.0</i>	Float value Float according to IEEE754	FLT	4	RW
128	15	Sensor test Channel Y reference value	<i>between -9999999.0 and 9999999.0</i>	Float value Float according to IEEE754	FLT	4	RW
128	16	Sensor test Channel X tolerance	<i>between 0.0 and 9999999.0</i>	Float value Float according to IEEE754	FLT	4	RW
128	17	Sensor test Channel Y tolerance	<i>between 0.0 and 9999999.0</i>	Float value Float according to IEEE754	FLT	4	RW
128	18	Initiate sensor test Note: Read access	0 1	NOK OK	U16	2	RO

Class	Attr.	Description	Value	Meaning of value	Type	Len	R/W
		initiates the sensor test and delivers the result.					

7.1.26 Setup user-defined values (Class 129)

Class	Attr.	Description	Value	Meaning of value	Type	Len	R/W
129	0	Not possible	-	-			X
129	1...9	Reserved	-	-			X
129	10	User-defined values value 1	<i>Integer value</i>	See operand table in appendix	U16	2	RW
129	11	User-defined values value 2	<i>Integer value</i>	See operand table in appendix	U16	2	RW
129	12	User-defined values value 3	<i>Integer value</i>	See operand table in appendix	U16	2	RW
129	13	User-defined values value 4	<i>Integer value</i>	See operand table in appendix	U16	2	RW
129	14	User-defined values value 5	<i>Integer value</i>	See operand table in appendix	U16	2	RW
129	15	User-defined values value 6	<i>Integer value</i>	See operand table in appendix	U16	2	RW
129	16	User-defined values value 7	<i>Integer value</i>	See operand table in appendix	U16	2	RW
129	17	User-defined values value 8	<i>Integer value</i>	See operand table in appendix	U16	2	RW
129	18	User-defined values value 9	<i>Integer value</i>	See operand table in appendix	U16	2	RW
129	19	User-defined values value 10	<i>Integer value</i>	See operand table in appendix	U16	2	RW
129	20	User-defined values value 11	<i>Integer value</i>	See operand table in appendix	U16	2	RW
129	21	User-defined values value 12	<i>Integer value</i>	See operand table in appendix	U16	2	RW
129	22	User-defined values value 13	<i>Integer value</i>	See operand table in appendix	U16	2	RW
129	23	User-defined values value 14	<i>Integer value</i>	See operand table in appendix	U16	2	RW
129	24	User-defined values value 15	<i>Integer value</i>	See operand table in appendix	U16	2	RW
129	25	User-defined values value 16	<i>Integer value</i>	See operand table in appendix	U16	2	RW
129	26	User-defined values value 17	<i>Integer value</i>	See operand table in appendix	U16	2	RW
129	27	User-defined values value 18	<i>Integer value</i>	See operand table in appendix	U16	2	RW
129	28	User-defined values value 19	<i>Integer value</i>	See operand table in appendix	U16	2	RW
129	29	User-defined values value 20	<i>Integer value</i>	See operand table in appendix	U16	2	RW

7.1.27 Copy/initialize measurement programs (Class 130)

Class	Attr.	Description	Value	Meaning of value	Type	Len	R/W
130	0	Not possible	-	-		X	X
130	1...9	Reserved	-	-		X	X
130	10	Meas. program number source Note: The settings from Attributes 10 - 12 are being adopted through Attributes 13, 14 or 15.	0 ... 15		U16	2	WO
130	11	Meas. program number Target start Note: The settings from Attributes 10 - 12 are being adopted through Attributes 13, 14 or 15.	0 ... 15		U16	2	WO
130	12	Meas. program number Target end Note: The settings from Attributes 10 - 12 are being adopted through Attributes 13, 14 or 15.	0 ... 15		U16	2	WO
130	13	Copy whole program setup Note: Copy according to entries in Attributes 10 - 12.	<i>EVENT</i>	Writing an arbitrary byte initiates action	U8	1	WO
130	14	Copy sensor setup Note: Copy according to entries in Attributes 10 - 12.	<i>EVENT</i>	Writing an arbitrary byte initiates action	U8	1	WO
130	15	Initialize selected programs Note: Initializing according to Attributes 11 - 12.	<i>EVENT</i>	Writing an arbitrary byte initiates action	U8	1	WO
130	16	Initialize all measurement programs and device parameters	<i>EVENT</i>	Writing an arbitrary byte initiates action	U8	1	WO

7.1.28 Reference curve (Class 131 to 133)

Class/index data on request

7.1.29 Test operation (Class 134)

Class	Attr.	Description	Value	Meaning of value	Type	Len	R/W
134	0	Not possible					
134	1...9	Reserved					
134	10	Current measurement value channel X	<i>Float value</i>	Float according to IEEE754	FLT	4	RO
134	11	Current measurement value channel Y	<i>Float value</i>	Float according to IEEE754	FLT	4	RO

7.1.30 Zoom and autoscale (Class 135)

Class	Attr.	Description	Value	Meaning of value	Type	Len	R/W
135	0	Not possible	-	-		X	X
135	1...9	Reserved	-	-		X	X
135	10	Switching autoscale/fix scale	0 1	Autoscale off Autoscale on	U16	2	RW
135	11	Fix scale Xmin Note: At the end, entry must be adopted through index 15.	<i>Float value</i>	Float according to IEEE754	FLT	4	RW
135	12	Fix scale Xmax Note: At the end, entry must be adopted through index 15.	<i>Float value</i>	Float according to IEEE754	FLT	4	RW
135	13	Fix scale Ymin Note: At the end, entry must be adopted through index 15.	<i>Float value</i>	Float according to IEEE754	FLT	4	RW
135	14	Fix scale Ymax Note: At the end, entry must be adopted through index 15.	<i>Float value</i>	Float according to IEEE754	FLT	4	RW
135	15	Store fix scale Note: Values entered into Attributes 11 - 14 are adopted.	<i>EVENT!</i>	Writing an arbitrary byte initiates action	U8	1	WO

7.1.31 USB-Logging (Class 136)

Class	Attr.	Description	Value	Meaning of value	Type	Len	R/W
136	0	Not possible	-	-		X	X
136	1...9	Reserved	-	-		X	X
136	10	USB-Logging on/off	0 1	off on	U16	2	RW
136	11	Designation of file name	0 1	Program name Order sheet	U16	2	RW
136	12	State of USB-Drive	0 1 2 3	State couldn't be read Not attached Attached but not mounted Attached and mounted	U16	2	RO
136	13	Free space on USB-Drive	String	If USB Drive is not attached or not mounted (see index 12) "0,000 MB" will be returned	STR 15	15	RO
136	14	Format USB Drive	String "formatusb"	"formatusb" works as a password here	STR 9	9	WO
136	15	READY-Control	0 1	off on	U16	2	RW

7.1.32 TEDS-Sensors (Class 137)

Class	Attr.	Description	Value	Meaning of value	Type	Len	R/W
137	0	Not possible	-	-		X	X
137	1...9	Reserved	-	-		X	X
137	10	Connector	0 1	A B	U16	2	WO
137	11	Direction Note: applicable for strain gauge sensors only	0 1	Preferred direction Against preferred direction	U16	2	WO
137	12	Read TEDS electronic data sheet from Connector specified at Attr. 10 with measurement direction according to Attr.11	EVENT!	Writing an arbitrary byte initiates action	U8	1	WO

7.1.33 Reserved Class (Class 138...148)

Class	Attr.	Description	Value	Meaning of value	Type	Len	R/W
138... 148	XX	Not possible	-	-	X	X	X

7.2 Measurement results

7.2.1 Status of measurement (Class 149)

Class	Attr.	Description	Value	Meaning of value	Type	Len	R/W
149	0	Not possible	-	-		X	X
149	1...9	Reserved				X	X
149	10	Index of the last measured value of the current curve Caution: The number of the pair of values is shown on the display. The index begins at 0, the number at 1!	<i>16 Bit Integer value</i>	0 means that there is no measurement curve	U16	2	RO
149	11	Running measurement curve counter [only relevant for Digicontrol usage]	<i>32 Bit Integer value</i>	This counter is incremented by 1 when a measurement curve is newly acquired in any menu	U32	4	RO
149	12	Amount of curves in current array of curves	<i>0...10</i>	Integer value between 0 and 10	U16	2	RO

7.2.2 Further information for current measurement curve (Class 150)

Class	Attr.	Description	Value	Meaning of value	Type	Len	R/W
150	0	Not possible	-	-		X	X
150	1...9	Reserved	-	-		X	X
150	10	Piece Counter	<i>32 Bit Integer value</i>		U32	4	RO
150	11	NOK counter (sum)	<i>32 Bit Integer value</i>		U32	4	RO
150	12	Total evaluation	<i>0 1</i>	NOK OK	U16	2	RO
150	13	Attr. of the curve's return point Caution: The number of the pair of values is shown on the display. The index begins at 0, the number at 1!	<i>16 Bit Integer value</i>		U16	2	RO
150	14	Index of the last measured value of the curve Caution: The number of the pair of values is shown on the display. The index begins at 0,	<i>16 Bit Integer value</i>		U16	2	RO

Class	Attr.	Description	Value	Meaning of value	Type	Len	R/W
		the number at 1!					
150	15	Status overdrive of the A/D converter	0 1	No overdrive Overdrive	U16	2	RO
150	16	Date of recording	<i>String in format dd.mm.yyyy</i>		STR 10	10	RO
150	17	Time of recording hh:mm:ss	<i>String in format hh:mm:ss</i>		STR 8	8	RO
150	18	Unit channel X	<i>String with max. 4 characters, e.g. "N" or "inch"</i>		STR 4	4	RO
150	19	Unit channel Y	<i>String with max. 4 characters, e.g. "N" or "inch"</i>		STR 4	4	RO

7.2.3 General curve data (Class 151)

Class	Attr.	Description	Value	Meaning of value	Type	Len	R/W
151	0	Not possible	-	-		X	X
151	1...9	Reserved	-	-		X	X
151	10	X-minimum, X-coordinate	<i>Float value</i>	Float according to IEEE754	FLT	4	RO
151	11	X-minimum, Y-coordinate	<i>Float value</i>	Float according to IEEE754	FLT	4	RO
151	12	X-maximum, X-coordinate	<i>Float value</i>	Float according to IEEE754	FLT	4	RO
151	13	X-maximum, Y-coordinate	<i>Float value</i>	Float according to IEEE754	FLT	4	RO
151	14	Y-minimum, X-coordinate	<i>Float value</i>	Float according to IEEE754	FLT	4	RO
151	15	Y-minimum, Y-coordinate	<i>Float value</i>	Float according to IEEE754	FLT	4	RO
151	16	Y-maximum, X-coordinate	<i>Float value</i>	Float according to IEEE754	FLT	4	RO
151	17	Y-maximum, Y-coordinate	<i>Float value</i>	Float according to IEEE754	FLT	4	RO
151	18	First value X-coordinate	<i>Float value</i>	Float according to IEEE754	FLT	4	RO
151	19	First value Y-coordinate	<i>Float value</i>	Float according to IEEE754	FLT	4	RO
151	20	Last value X-coordinate	<i>Float value</i>	Float according to IEEE754	FLT	4	RO
151	21	Last value Y-coordinate	<i>Float value</i>	Float according to IEEE754	FLT	4	RO

Class	Attr.	Description	Value	Meaning of value	Type	Len	R/W
151	22	Return point X-coordinate	<i>Float value</i>	Float according to IEEE754	FLT	4	RO
151	23	Return point Y-coordinate	<i>Float value</i>	Float according to IEEE754	FLT	4	RO

7.2.4 Request measurement results of user-defined values (Class 152)

Class	Attr.	Description	Value	Meaning of value	Type	Len	R/W
152	0	Not possible	-	-		X	X
152	1...9	Reserved	-	-		X	X
152	10	User-defined value 1 name	<i>String with the designator of the value</i>	Designator = "0" means that no value is defined for this value number	STR 16	16	RO
152	11	User-defined value 1 measurement value	<i>Float value</i>	Float according to IEEE754	FLT	4	RO
152	12	User-defined value 1 unit	<i>String with max. 4 characters, e.g. "N" or "inch"</i>	See operand table in appendix.	STR 4	4	RO
152	13	User-defined value 2 name	<i>String with the designator of the value</i>	Designator = "0" means that no value is defined for this value number	STR 16	16	RO
152	14	User-defined value 2 measurement value	<i>Float value</i>	Float according to IEEE754	FLT	4	RO
152	15	User-defined value 2 unit	<i>String with max. 4 characters, e.g. "N" or "inch"</i>	See operand table in appendix.	STR 4	4	RO
152	16	User-defined value 3 name	<i>String with the designator of the value</i>	Designator = "0" means that no value is defined for this value number	STR 16	16	RO
152	17	User-defined value 3 measurement value	<i>Float value</i>	Float according to IEEE754	FLT	4	RO
152	18	User-defined value 3 unit	<i>String with max. 4 characters, e.g. "N" or "inch"</i>	See operand table in appendix.	STR 4	4	RO
152	19	User-defined value 4 name	<i>String with the designator of the value</i>	Designator = "0" means that no value is defined for this value number	STR 16	16	RO
152	20	User-defined value 4 measurement value	<i>Float value</i>	Float according to IEEE754	FLT	4	RO
152	21	User-defined value 4 unit	<i>String with max. 4</i>	See operand table in appendix.	STR 4	4	RO

Class	Attr.	Description	Value	Meaning of value	Type	Len	R/W
			<i>characters, e.g. "N" or "inch"</i>				
152	22	User-defined value 5 name	<i>String with the designator of the value</i>	Designator = "0" means that no value is defined for this value number	STR 16	16	RO
152	23	User-defined value 5 measurement value	<i>Float value</i>	Float according to IEEE754	FLT	4	RO
152	24	User-defined value 5 unit	<i>String with max. 4 characters, e.g. "N" or "inch"</i>	See operand table in appendix.	STR 4	4	RO
152	25	User-defined value 6 name	<i>String with the designator of the value</i>	Designator = "0" means that no value is defined for this value number	STR 16	16	RO
152	26	User-defined value 6 measurement value	<i>Float value</i>	Float according to IEEE754	FLT	4	RO
152	27	User-defined value 6 unit	<i>String with max. 4 characters, e.g. "N" or "inch"</i>	See operand table in appendix.	STR 4	4	RO
152	28	User-defined value 7 name	<i>String with the designator of the value</i>	Designator = "0" means that no value is defined for this value number	STR 16	16	RO
152	29	User-defined value 7 measurement value	<i>Float value</i>	Float according to IEEE754	FLT	4	RO
152	30	User-defined value 7 unit	<i>String with max. 4 characters, e.g. "N" or "inch"</i>	See operand table in appendix.	STR 4	4	RO
152	31	User-defined value 8 name	<i>String with the designator of the value</i>	Designator = "0" means that no value is defined for this value number	STR 16	16	RO
152	32	User-defined value 8 measurement value	<i>Float value</i>	Float according to IEEE754	FLT	4	RO
152	33	User-defined value 8 unit	<i>String with max. 4 characters, e.g. "N" or "inch"</i>	See operand table in appendix.	STR 4	4	RO
152	34	User-defined value 9 name	<i>String with the designator of the value</i>	Designator = "0" means that no value is defined for this value number	STR 16	16	RO
152	35	User-defined value 9 measurement value	<i>Float value</i>	Float according to IEEE754	FLT	4	RO

Class	Attr.	Description	Value	Meaning of value	Type	Len	R/W
152	36	User-defined value 9 unit	<i>String with max. 4 characters, e.g. "N" or "inch"</i>	See operand table in appendix.	STR 4	4	RO
152	37	User-defined value 10 name	<i>String with the designator of the value</i>	Designator = "0" means that no value is defined for this value number	STR 16	16	RO
152	38	User-defined value 10 measurement value	<i>Float value</i>	Float according to IEEE754	FLT	4	RO
152	39	User-defined value 10 unit	<i>String with max. 4 characters, e.g. "N" or "inch"</i>	See operand table in appendix.	STR 4	4	RO
152	40	User-defined value 11 name	<i>String with the designator of the value</i>	Designator = "0" means that no value is defined for this value number	STR 16	16	RO
152	41	User-defined value 11 measurement value	<i>Float value</i>	Float according to IEEE754	FLT	4	RO
152	42	User-defined value 11 unit	<i>String with max. 4 characters, e.g. "N" or "inch"</i>	See operand table in appendix.	STR 4	4	RO
152	43	User-defined value 12 name	<i>String with the designator of the value</i>	Designator = "0" means that no value is defined for this value number	STR 16	16	RO
152	44	User-defined value 12 measurement value	<i>Float value</i>	Float according to IEEE754	FLT	4	RO
152	45	User-defined value 12 unit	<i>String with max. 4 characters, e.g. "N" or "inch"</i>	See operand table in appendix.	STR 4	4	RO
152	46	User-defined value 13 name	<i>String with the designator of the value</i>	Designator = "0" means that no value is defined for this value number	STR 16	16	RO
152	47	User-defined value 13 measurement value	<i>Float value</i>	Float according to IEEE754	FLT	4	RO
152	48	User-defined value 13 unit	<i>String with max. 4 characters, e.g. "N" or "inch"</i>	See operand table in appendix.	STR 4	4	RO
152	49	User-defined value 14 name	<i>String with the designator of the value</i>	Designator = "0" means that no value is defined for this value number	STR 16	16	RO

Class	Attr.	Description	Value	Meaning of value	Type	Len	R/W
152	50	User-defined value 14 measurement value	Float value	Float according to IEEE754	FLT	4	RO
152	51	User-defined value 14 unit	String with max. 4 characters, e.g. "N" or "inch"	See operand table in appendix.	STR 4	4	RO
152	52	User-defined value 15 name	String with the designator of the value	Designator = "0" means that no value is defined for this value number	STR 16	16	RO
152	53	User-defined value 15 measurement value	Float value	Float according to IEEE754	FLT	4	RO
152	54	User-defined value 15 unit	String with max. 4 characters, e.g. "N" or "inch"	See operand table in appendix.	STR 4	4	RO
152	55	User-defined value 16 name	String with the designator of the value	Designator = "0" means that no value is defined for this value number	STR 16	16	RO
152	56	User-defined value 16 measurement value	Float value	Float according to IEEE754	FLT	4	RO
152	57	User-defined value 16 unit	String with max. 4 characters, e.g. "N" or "inch"	See operand table in appendix.	STR 4	4	RO
152	58	User-defined value 17 name	String with the designator of the value	Designator = "0" means that no value is defined for this value number	STR 16	16	RO
152	59	User-defined value 17 measurement value	Float value	Float according to IEEE754	FLT	4	RO
152	60	User-defined value 17 unit	String with max. 4 characters, e.g. "N" or "inch"	See operand table in appendix.	STR 4	4	RO
152	61	User-defined value 18 name	String with the designator of the value	Designator = "0" means that no value is defined for this value number	STR 16	16	RO
152	62	User-defined value 18 measurement value	Float value	Float according to IEEE754	FLT	4	RO
152	63	User-defined value 18 unit	String with max. 4 characters, e.g. "N" or "inch"	See operand table in appendix.	STR 4	4	RO
152	64	User-defined value 19 name	String with the	Designator = "0" means that no value is defined for this	STR 16	16	RO

Class	Attr.	Description	Value	Meaning of value	Type	Len	R/W
			designator of the value	value number			
152	65	User-defined value 19 measurement value	Float value	Float according to IEEE754	FLT	4	RO
152	66	User-defined value 19 unit	String with max. 4 characters, e.g. "N" or "inch"	See operand table in appendix.	STR 4	4	RO
152	67	User-defined value 20 name	String with the designator of the value	Designator = "0" means that no value is defined for this value number	STR 16	16	RO
152	68	User-defined value 20 measurement value	Float value	Float according to IEEE754	FLT	4	RO
152	69	User-defined value 20 unit	<i>String with max. 4 characters, e.g. "N" or "inch"</i>	See operand table in appendix.	STR 4	4	RO

7.2.5 Read-out X-coordinates of current measurement curve (Class 153)

Sequence to read the curve coordinates

1. Load the curve into the field bus card through a write access to index 10.
2. Query the last measured value for the curve (→ end of the curve) through a read access to index 10.
3. The curve can now be read out in coordinate groups of up to 300 coordinates each or 300 coordinates of selected group (attribute 19) can be read in one go over attribute 11 if specified:
 Coordinate group 0: Measured value 0 ... 299
 Coordinate group 1: Measured value 300 ... 599
 Coordinate group 2: Measured value 600 ... 899 ... etc.

Note: Please note that you have to announce the DIGIFORCE® 9311 the length of the buffer to write the curve coordinates. Maximum buffer size required to store 300 float coordinates is 1200 bytes. The device will not send more bytes than you announces.

4. The number of the desired coordinate group is entered through a write access to index 19. Since we want to read the beginning of the curve, we enter a 0.

It is now possible to read curve values no. 0 ... 299 (at present we have selected coordinate group 0) at the Attributes 20 ... 319.

5. Coordinate group 1 (values 300 ... 599) is now read under index 19. It is now possible to read curve values no. 300 ... 599 at Attributes 20 ... 319.
6. After this, coordinate group 2 (values 600 ... 899) is read under index 19. It is now possible to read curve values no. 600 ... 899 at Attributes 20 ... 319, and so forth.
7. The coordinate groups can be read out in any desired sequence.
8. Only curve values that are smaller than or equal to the number of the last measured value (which was read at index 10) may be read out.

Class	Attr.	Description	Value	Meaning of value	Type	Len	R/W
153	0	Not possible	-	-		X	X
153	1...9	Reserved	-	-		X	X
153	10	Write access: If a curve is to be read, it must be prepared through a write access before the curve is first read.	<i>EVENT!</i> <i>Writing any two arbitrary bytes initiates action</i>		U16	2	W_
		Read access: Index of the last coordinate; if 0, there is no curve	<i>Integer value</i> <i>0...4999</i>		U16	2	R_
153	11	Up to 300 coordinates of selected group (s. attribute 19) as float array. Note: Before reading the coordinates perform a write access on index 10 to prepare the curve and a read access on the same index 10 to determine the number of coordinates	<i>Float array of 0...300 values</i>	Float array according to IEEE754	FLT	0-1200	RO
153	12...18	Reserved	-	-		X	X
153	19	Write access: Desired group of 300 coordinates. For example, if coordinates 900 ... 1199 are to be displayed, there must be a 3 here. Query the maximum number of value pairs under Class 153/10.	<i>Integer value</i> <i>0 ... 24</i>		U16	2	W_
		Read access: Group of 300 coordinates currently displayed.	<i>Integer value</i> <i>0 ... 24</i>		U16	2	R_
153	20	0. coordinate of group of coordinates	<i>Float value</i>	Float according to IEEE754	FLT	4	RO
153	21	1. coordinate of group of coordinates	<i>Float value</i>	Float according to IEEE754	FLT	4	RO
153	22	2. coordinate of group of coordinates	<i>Float value</i>	Float according to IEEE754	FLT	4	RO

Class	Attr.	Description	Value	Meaning of value	Type	Len	R/W
153	23	3. coordinate of group of coordinates	<i>Float value</i>	Float according to IEEE754	FLT	4	RO
153
153	317	297. coordinate of group of coordinates	<i>Float value</i>	Float according to IEEE754	FLT	4	RO
153	318	298. coordinate of group of coordinates	<i>Float value</i>	Float according to IEEE754	FLT	4	RO
153	319	299. coordinate of group of coordinates	<i>Float value</i>	Float according to IEEE754	FLT	4	RO

7.2.6 Read-out Y-coordinates of current measurement curve (Class 154)

Class	Attr.	Description	Value	Meaning of value	Type	Len	R/W
154	0	Not possible	-	-		X	X
154	1...9	Reserved	-	-		X	X
154	10...	See Class 153				X	X

7.2.7 Evaluation results window 1 (Class 155)

Class	Attr.	Description	Value	Meaning of value	Type	Len	R/W
155	0	Not possible	-	-		X	X
155	1...9	Reserved	-	-		X	X
155	10	Window 1 evaluation results OK/NOK	0 1	NOK OK	U16	2	RO
155	11	Window 1 NOK counter	<i>32bit-Integer value >= 0</i>		U32	4	RO
155	12	Window 1 entry of curve X-coordinate	<i>Float value</i>	Float according to IEEE754	FLT	4	RO
155	13	Window 1 entry of curve Y-coordinate	<i>Float value</i>	Float according to IEEE754	FLT	4	RO
155	14	Window 1 exit of curve X-coordinate	<i>Float value</i>	Float according to IEEE754	FLT	4	RO
155	15	Window 1 exit of curve Y-coordinate	<i>Float value</i>	Float according to IEEE754	FLT	4	RO
155	16	Window 1 absolute maximum in window X-coordinate	<i>Float value</i>	Float according to IEEE754	FLT	4	RO
155	17	Window 1 absolute maximum in window Y-coordinate	<i>Float value</i>	Float according to IEEE754	FLT	4	RO
155	18	Window 1 absolute minimum in window X-coordinate	<i>Float value</i>	Float according to IEEE754	FLT	4	RO
155	19	Window 1 absolute minimum in window Y-coordinate	<i>Float value</i>	Float according to IEEE754	FLT	4	RO

7.2.8 Evaluation results window 2 (Class 156)

Class	Attr.	Description	Value	Meaning of value	Type	Len	R/W
156	0	Not possible	-	-		X	X
156	1...9	Reserved	-	-		X	X
156	10...	See Class 155				X	X

7.2.9 Evaluation results window 3 (Class 157)

Class	Attr.	Description	Value	Meaning of value	Type	Len	R/W
157	0	Not possible	-	-		X	X
157	1...9	Reserved	-	-		X	X
157	10...	See Class 155				X	X

7.2.10 Evaluation results threshold 1 (Class 158)

Class	Attr.	Description	Value	Meaning of value	Type	Len	R/W
158	0	Not possible	-	-		X	X
158	1...9	Reserved	-	-		X	X
158	10	Threshold 1 evaluation result OK/NOK	0 1	NOK OK	U16	2	RO
158	11	Threshold 1 NOK counter	32bit-Integer value >= 0		U32	4	RO
158	12	Threshold intersection point X-coordinate	Float value	Float according to IEEE754	FLT	4	RO
158	13	Threshold intersection point Y-coordinate	Float value	Float according to IEEE754	FLT	4	RO

7.2.11 Evaluation results threshold 2 (Class 159)

Class	Attr.	Description	Value	Meaning of value	Type	Len	R/W
159	0	Not possible	-	-		X	X
159	1...9	Reserved	-	-		X	X
159	10...	See Class 158				X	X

7.2.12 Evaluation results trapezoid window 1 (Class 160)

Class	Attr.	Description	Value	Meaning of value	Type	Len	R/W
160	0	Not possible	-	-		X	X
160	1...9	Reserved	-	-		X	X
160	10	Trapezoid 1 evaluation result OK/NOK	0 1	NOK OK	U16	2	RO
160	11	Trapezoid 1 NOK counter	32bit-Integer value >= 0		U32	4	RO
160	12	Trapezoid 1 entry coordinate X-coordinate	Float value	Float according to IEEE754	FLT	4	RO
160	13	Trapezoid 1 entry coordinate Y-coordinate	Float value	Float according to IEEE754	FLT	4	RO
160	14	Trapezoid 1 exit coordinate X-coordinate	Float value	Float according to IEEE754	FLT	4	RO
160	15	Trapezoid 1 exit coordinate Y-coordinate	Float value	Float according to IEEE754	FLT	4	RO

7.2.13 Evaluation results trapezoid window 2 (Class 161)

Class	Attr.	Description	Value	Meaning of value	Type	Len	R/W
161	0	Not possible	-	-		X	X
161	1...9	Reserved	-	-		X	X
161	10...	See Class 160				X	X

7.2.14 Evaluation results envelope (Class 162)

Class	Attr.	Description	Value	Meaning of value	Type	Len	R/W
162	0	Not possible	-	-		X	X
162	1...9	Reserved	-	-		X	X
162	10	Envelope 1 evaluation result OK/NOK	0 1	NOK OK	U16	2	RO
162	11	Envelope 1 NOK counter	32bit-Integer value >= 0		U32	4	RO
162	12	Envelope 1 entry coordinate X-coordinate	Float value	Float according to IEEE754	FLT	4	RO
162	13	Envelope 1 entry coordinate Y-coordinate	Float value	Float according to IEEE754	FLT	4	RO
162	14	Envelope 1 exit coordinate X-coordinate	Float value	Float according to IEEE754	FLT	4	RO

Class	Attr.	Description	Value	Meaning of value	Type	Len	R/W
162	15	Envelope 1 exit coordinate Y-coordinate	<i>Float value</i>	Float according to IEEE754	FLT	4	RO

7.2.15 Combined results (common curve data and evaluation elements – Class 163)

Class	Attr.	Description	Value	Meaning of value	Type	Len	R/W
163	0	Not possible	-			X	X
163	1...9	Reserved	-			X	X
163	10	Combined results: general curve data Y	<i>The data is bit coded and transmitted as STRUCT.</i> X-minimum, X-coord. (FL) X-minimum, Y-coord. (FL) X-maximum, X-coord. (FL) X-maximum, Y-coord. (FL) Y-minimum, X-coord. (FL) Y-minimum, Y-coord.(FL) Y-maximum, X-coord. (FL) Y-maximum, Y-coord.(FL) First value X-coord. (FL) First value Y-coord. (FL) Last value X-coord. (FL) Last value Y-coord. (FL) Return point X-coord. (FL) Return point Y-coord. (FL)		STRUCT OF FLOATS	56	RO
163	11	Combined results: window 1	<i>The data is bit coded and transmitted as STRUCT.</i> Evaluation result (UINT32): 0: NOK 1: OK Entry X-coordinate (FL) Entry Y-coordinate (FL) Exit X-coordinate (FL) Exit Y-coordinate (FL) Absolute max X-coord. (FL) Absolute max Y- coord.(FL) Absolute min X- coord. (FL) Absolute min Y- coord. (FL) Window Xmin coord. (FL) Window Xmax coord. (FL) Window Ymin coord. (FL) Window Ymax coord. (FL)		STRUCT	52	RO
163	12	Combined results: window 2	<i>See index 11</i>		STRUCT	52	RO
163	13	Combined results: window 3	<i>See index 11</i>		STRUCT	52	RO

Class	Attr.	Description	Value	Meaning of value	Type	Len	R/W
163	14	Combined results: threshold 1	<p><i>The data is bit coded and transmitted as STRUCT:</i></p> <p>Evaluation result (UINT32): 0: NOK 1: OK</p> <p>Threshold type (UINT32): 0: Type X-Threshold 1: Type Y-Threshold</p> <p>Threshold pass X (FL) Threshold pass Y (FL) Type X: Position X value (FL) Type Y: Position Y value (FL) Type X: Ymin value (FL) Type Y: Xmin value (FL) Type X: Ymax value (FL) Type Y: Xmax value (FL)</p>		STRUCT	28	RO
163	15	Combined results: threshold 2	See index 14		STRUCT	28	RO
163	16	Combined results: trapezoid window 1	<p><i>The data is bit coded and transmitted as STRUCT:</i></p> <p>Evaluation result (UINT32) 0: NOK 1: OK</p> <p>Threshold type (UINT32) 0: Type X-Trapezoid 1: Type Y-Trapezoid</p> <p>Entry X-coord. (FL) Entry Y-coord. (FL) Exit X-coord. (FL) Exit Y-coord. (FL) Type X: Xmin (FL) Type Y: Ymin (FL) Type X: Xmax (FL) Type Y: Ymax (FL) Type X: Ymin left (FL) Type Y: Xmin bottom (FL) Type X: Ymax left (FL) Type Y: Xmax bottom (FL) Type X: Ymin right (FL) Type Y: Xmin top (FL) Type X: Ymax right (FL) Type Y: Xmax top (FL)</p>		STRUCT	48	RO
163	17	Combined results: trapezoid window 2	See index 16		STRUCT	48	RO
163	18	Combined results: envelope	<p><i>The data is bit coded and transmitted as STRUCT:</i></p> <p>Evaluation result (UINT32): 0: NOK 1: OK</p> <p>Entry X-coordinate (FL) Entry Y-coordinate (FL) Exit X-coordinate (FL) Exit Y-coordinate (FL)</p>		STRUCT	36	RO

Class	Attr.	Description	Value	Meaning of value	Type	Len	R/W
			Envelope start (FL) Envelope end (FL) Delta min (FL) Delta max (FL)				

8 Appendix

8.1 Operand table

Number	ID of operant
0	OFF
100	General curve data – Start X
101	General curve data – Start Y
102	General curve data – End X
103	General curve data – End Y
104	General curve data – Abs. Xmax X-coordinate
105	General curve data – Abs. Xmax Y-coordinate
106	General curve data – Abs. Xmin X-coordinate
107	General curve data – Abs. Xmin Y-coordinate
108	General curve data – Abs. Ymax X-coordinate
109	General curve data – Abs. Ymax Y-coordinate
110	General curve data – Abs. Ymin X-coordinate
111	General curve data – Abs. Ymin Y-coordinate
112	General curve data – Return point X-coordinate
113	General curve data – Return point Y-coordinate
200	Window 1 – Entry X
201	Window 1 – Entry Y
202	Window 1 – Exit X
203	Window 1 – Exit Y
204	Window 1 – Abs. minimum X
205	Window 1 – Abs. minimum Y
206	Window 1 – Abs. maximum X
207	Window 1 – Abs. maximum Y
208	Window 1 – Coordinate Xmin
209	Window 1 – Coordinate Xmax

Number	ID of operant
210	Window 1 – Coordinate Ymin
211	Window 1 – Coordinate Ymax
300	Window 2 – Entry X
301	Window 2 – Entry Y
302	Window 2 – Exit X
303	Window 2 – Exit Y
304	Window 2 – Abs. minimum X
305	Window 2 – Abs. minimum Y
306	Window 2 – Abs. maximum X
307	Window 2 – Abs. maximum Y
308	Window 2 – Coordinate Xmin
309	Window 2 – Coordinate Xmax
310	Window 2 – Coordinate Ymin
311	Window 2 – Coordinate Ymax
400	Window 3 – Entry X
401	Window 3 – Entry Y
402	Window 3 – Exit X
403	Window 3 – Exit Y
404	Window 3 – Abs. minimum X
405	Window 3 – Abs. minimum Y
406	Window 3 – Abs. maximum X
407	Window 3 – Abs. maximum Y
408	Window 3 – Coordinate Xmin
409	Window 3 – Coordinate Xmax
410	Window 3 – Coordinate Ymin
411	Window 3 – Coordinate Ymax

Number	ID of operand
500	Trapezoid window 1 – Entry X
501	Trapezoid window 1 – Entry Y
502	Trapezoid window 1 – Exit X
503	Trapezoid window 1 – Exit Y
504	Trapezoid window 1 – Coordinate Type X: Xmin Type Y: Ymin
505	Trapezoid window 1 – Coordinate Type X: Xmax Type Y: Ymax
506	Trapezoid window 1 – Coordinate Type X: Ymin left Type Y: Xmin bottom
507	Trapezoid window 1 – Coordinate Type X: Ymax left Type Y: Xmax bottom
508	Trapezoid window 1 – Coordinate Type X: Ymin right Type Y: Xmin top
509	Trapezoid window 1 – Coordinate Type X: Ymax right Type Y: Xmax top
600	Trapezoid window 2 – Entry X
601	Trapezoid window 2 – Entry Y
602	Trapezoid window 2 – Exit X
603	Trapezoid window 2 – Exit Y
604	Trapezoid window 2 – Coordinate Type X: Xmin Type Y: Ymin
605	Trapezoid window 2 – Coordinate Type X: Xmax Type Y: Ymax
606	Trapezoid window 2 – Coordinate Type X: Ymin left Type Y: Xmin bottom
607	Trapezoid window 2 – Coordinate Type X: Ymax left Type Y: Xmax bottom
608	Trapezoid window 2 – Coordinate Type X: Ymin right Type Y: Xmin top
609	Trapezoid window 2 – Coordinate Type X: Ymax right Type Y: Xmax top

Number	ID of operant
700	Threshold 1 – Pass X
701	Threshold 1 – Pass Y
702	Threshold 1 – Coordinate Type X: Position X value Type Y: Position Y value
703	Threshold 1 – Coordinate Type X: Ymin value Type Y: Xmin value
704	Threshold 1 – Coordinate Type X: Ymax value Type Y: Xmax value
800	Threshold 2 – Pass X
801	Threshold 2 – Pass Y
802	Threshold 2 – Coordinate Type X: Position X value Type Y: Position Y value
803	Threshold 2 – Coordinate Type X: Ymin value Type Y: Xmin value
804	Threshold 2 – Coordinate Type X: Ymax value Type Y: Xmax value
900	Envelope – Entry X
901	Envelope – Entry Y
902	Envelope – Exit X
903	Envelope – Exit Y
904	Envelope – Coordinate Start X
905	Envelope – Coordinate End X

9 Error Codes

Error Code	Description
0x00	GSR_SUCCESS <i>No error, write/read successful</i>
0x05	EIP_GSR_BAD_CLASS_INSTANCE <i>This class/instance is not specified</i> Note: <i>Only instance 1 is supported</i>
0x09	EIP_GSR_BAD_ATTR_DATA <i>The write request has been declined.</i> <i>Please check your data and data length here</i>
0x0F	EIP_GSR_PERMISSION_DENIED <i>Reading /Writing of this attribute is not supported</i>
0x14	EIP_GSR_UNDEFINED_ATTR <i>This attribute is not implemented by the firmware. Please refer to operation manual to check whether the attribute number is correct.</i>
0x1E	EIP_GSR_SERVICE_ERROR <i>Read/Write request has been declined by device. Please refer to device operation manual to check if this parameter is writeable/readable</i>
0xB2	EIP_GSR_RESERVED_CLASS <i>Read/Write from/to this class is not supported</i>