

OPERATION MANUAL

DIGIFORCE[®] Cabinet module Model 9311-V2xxx

© 2018 burster
praezisionsmesstechnik gmbh & co kg
All rights reserved

Manufacturer:
burster
praezisionsmesstechnik gmbh & co kg
Talstr. 1 - 5 P.O.Box 1432
76593 Gernsbach 75689 Gernsbach
Germany Germany

Valid from: 20.04.2018
DIGIFORCE[®] 9311-V2xxx

Tel.: +49-7224-645-0
Fax.: +49-7224-645-88
Email: info@burster.com
www.burster.com

2727-BA9311CMEN-5170-041522

Warranty disclaimer

All information in the present documentation was prepared and compiled with great care and reproduced in accordance with effective control measures. This documentation may contain errors, and the information it contains and the corresponding technical data are subject to change without notice. Reproduction of any part of this documentation or its processing or revision using electronic systems is prohibited without the manufacturer's prior written approval.

Components, devices and measurement sensors made by burster praezisionsmesstechnik (hereinafter referred to as the "product") are the result of targeted development and meticulous research. From the date of delivery, burster provides a warranty for the proper condition and functioning of these products covering material and production defects for the period specified in the warranty document accompanying the product. However, burster waives any guarantee or warranty obligations or any additional liability for consequential damages caused by improper use of the product, in particular the implied guarantee of success in the market as well as the suitability of the product for a particular purpose. Furthermore, burster assumes no liability for direct, indirect or incidental damages or for consequential or other damages arising from the provision and use of the present documentation.

Trademark information

1-Wire® is a registered trade mark of Maxim Integrated. Windows®, Excel® are registered trademarks or trademarks of Microsoft Corporation in the United States and/or other countries. PROFIBUS and PROFINET are registered trademarks of PROFIBUS and PROFINET International (PI). EtherNet/IP is a registered trademark of the ODVA. All brand names or trademarks mentioned in this document refer solely to the products concerned and are the property of their respective owners. By mentioning these trademarks, burster praezisionsmesstechnik gmbh & co kg is not laying claim to trademarks other than its own.

The measurement solution.



EU-Konformitätserklärung (nach EN ISO/IEC 17050-1:2010)

EU-Declaration of conformity (in accordance with EN ISO/IEC 17050-1:2010)

Name des Ausstellers: burster präzisionsmesstechnik gmbh & co kg
Issuer's name:

Anschrift des Ausstellers: Talstr. 1-5
Issuer's address: 76593 Gernsbach, Germany

Gegenstand der Erklärung: DIGIFORGE® X/Y-Monitoring, Einpress-, Füge-, Niet- und Verstemmüberwachung
Object of the declaration: DIGIFORGE® X/Y-Monitoring, press-fit, joining, rivet and caulking monitoring

Modellnummer(n) (Typ): DIGIFORCE® 9311
Model number / type:

Diese Erklärung beinhaltet obengenannte Produkte mit allen Optionen
This declaration covers all options of the above product(s)

Das oben beschriebene Produkt ist konform mit den Anforderungen der folgenden Dokumente:

The object of the declaration described above is in conformity with the requirements of the following documents:

Dokument-Nr. <i>Documents No.</i>	Titel <i>Title</i>	Ausgabe <i>Edition</i>
2011/65/EU	Richtlinie zur Beschränkung der Verwendung bestimmter gefährlicher Stoffe in Elektro- und Elektronikgeräten <i>Directive on the restriction of the use of certain hazardous substances in electrical and electronic equipment</i>	2011
2014/35/EU	Richtlinie zur Harmonisierung der Rechtsvorschriften der Mitgliedsstaaten über die Bereitstellung elektrischer Betriebsmittel zur Verwendung innerhalb bestimmter Spannungsgrenzen auf dem Markt <i>Directive on the harmonization of the laws of the Member States relating to the making available on the market of electrical equipment designed for use within certain voltage limits</i>	2014
2014/30/EU	Richtlinie zur Harmonisierung der Rechtsvorschriften der Mitgliedsstaaten über die Elektromagnetische Verträglichkeit <i>Directive on the harmonization of the laws of the Member States relating to electromagnetic compatibility</i>	2014
EN 61010-1	Sicherheitsbestimmungen für elektrische Mess-, Steuer-, Regel- und Laborgeräte – Teil 1: Allgemeine Anforderungen <i>Safety requirements for electrical equipment for measurement, control and laboratory use – Part 1: General requirements</i>	2010 + Cor.:2011
EN 61326-1	Elektrische Mess-, Steuer-, Regel- und Laborgeräte – EMV-Anforderungen – Teil 1: Allgemeine Anforderungen <i>Electrical equipment for measurement, control and laboratory use – EMC requirements – Part 1: General requirements</i>	2013
EN 55011	Industrielle, wissenschaftliche und medizinische Geräte – Funkstörungen – Grenzwerte und Messverfahren, Gruppe 1, Grenzwertklasse A <i>Industrial, scientific and medical equipment – Radio-frequency disturbance characteristics – Limits and methods of measurement, group 1, class A</i>	2009 + A1: 2010

Gernsbach 01.04.2016 i.V. Christian Karius
Ort / place Datum / date Quality Manager

Dieses Dokument ist entsprechend EN ISO/IEC 17050-1:2010 Abs. 6.1g ohne Unterschrift gültig /
According EN ISO/IEC 17050 this document is valid without a signature.

WARNHINWEIS: Dies ist ein Klasse A-Erzeugnis, vorgesehen für den Betrieb in einer industriellen Umgebung.
WARNING: This is a Class A-product, designed to operate in an industrial setting.

burster präzisionsmesstechnik gmbh & co kg · Talstr. 1-5 DE-76593 Gernsbach (P.O.Box 1432 DE-76587 Gernsbach) · Tel. +49-7224-6450 · Fax 645-88
www.burster.com · info@burster.com · burster is ISO 9001:2008 certified

Geschäftsführer/Managing Director: Matthias Burster · Handelsregister/Trade Register: Gernsbach · Registergericht/Register Court: Mannheim HRA 530170
Kompl./Gen. Partn.: burster präzisionsmesstechnik Verwaltungs-GmbH · Handelsregister/Trade Register: Gernsbach · Registergericht/Register Court: Mannheim HRB 530130
UST-Identnr./VAT No. DE 144 005 098 · Steuernr./Tax Ident No. 39454/10503
Commerzbank AG Rastatt Kto./Acc. 06 307 073 00 BLZ/Bank code 662 800 53 · Volksbank Baden-Baden *Rastatt eG Kto./Acc. 302 082 00 BLZ/Bank code 662 900 00

Contents

1	For your safety	8
1.1	Symbols used in this manual.....	8
1.1.1	Signal words.....	8
1.1.2	Pictograms.....	9
1.2	Symbols and precautionary statements on the instrument.....	9
1.2.1	Conventions used in the instruction manual.....	9
2	Introduction	10
2.1	Intended use.....	10
2.2	Customer Service.....	10
2.2.1	Customer service department.....	10
2.2.2	Contact person.....	10
2.3	Download the test certificate.....	10
2.4	Ambient conditions.....	11
2.4.1	Storage conditions.....	11
2.4.2	Operating conditions.....	11
2.4.3	Restrictions on use.....	11
2.4.4	Cleaning.....	12
2.5	Personnel.....	12
2.6	Contents of pack.....	12
2.7	Unpacking.....	13
2.8	Warranty.....	13
2.9	Conversions and modifications.....	13
3	Principles of design and operation	14
3.1	Range of functions.....	14
3.2	Versions.....	14
3.3	Power supply.....	15
3.4	Sensors suitable for use with the DIGIFORCE® 9311.....	15
3.4.1	Automatic sensor identification (burster TEDS).....	16
3.5	Recording measurement curves.....	16
3.5.1	Starting / stopping a measurement.....	16
3.5.2	Sampling the measurement signals.....	17
3.5.3	Defining an X-axis reference.....	17
3.6	Evaluation methods.....	18
3.7	Tare function.....	18
3.8	Sensor test.....	19
3.9	Online switching points.....	19
3.10	Visualizing, signaling and transferring results.....	19
4	Controls and connections	20
4.1	Status LED (normal operation).....	21
4.2	Grounding and shielding.....	22
4.3	Connections.....	23

4.3.1	Connection for the DC power supply	23
4.3.2	PLC I/O signals	23
4.3.3	Connector A – Potentiometer, Standard signal	26
4.3.3.1	Connector A: connecting potentiometric sensors.....	27
4.3.3.2	Connector A: connecting potentiometric sensors fitted with burster TEDS	27
4.3.3.3	Connector A: connecting standard-signal sensors	27
4.3.3.4	Connector A: connecting standard-signal sensors fitted with burster TEDS	28
4.3.4	Connector B – strain gage sensors, standard-signal sensors.....	29
4.3.4.1	Connector B: connecting strain gage sensors without sense leads	30
4.3.4.2	Connector B: connecting strain gage sensors without sense leads, fitted with burster TEDS.....	30
4.3.4.3	Connector B: connecting strain gage sensors with sense leads.....	30
4.3.4.4	Connector B: connecting strain gage sensors with sense leads, fitted with burster TEDS.....	31
4.3.4.5	Connector B: connecting standard-signal sensors	31
4.3.4.6	Connector B: connecting standard-signal sensors fitted with burster TEDS	31
4.3.4.7	Connector B: connecting a piezoelectric sensor (option).....	32
4.3.5	USB service port.....	33
4.3.6	Ethernet port	34
4.3.7	USB host port (memory-stick data logging).....	34
4.3.8	PROFIBUS interface.....	35
4.3.9	Ethernet-based Fieldbus interface (dual RJ45).....	35
5	Using the DIGIFORCE® 9311 for the first time.....	36
5.1	35 mm DIN rail mounting/removal.....	36
5.2	DigiControl PC software	38
5.2.1	Controls and symbols	39
6	Configuring the unit	40
6.1	Establishing a connection to the DigiControl PC software (USB or Ethernet)	40
6.2	DIGIFORCE® 9311 device information (Properties).....	41
6.2.1	Station properties.....	41
6.2.2	Ethernet interface configuration.....	42
6.2.3	Station properties for station - Measurement mode	44
6.3	Device settings	45
6.3.1	Basic setup	47
6.3.1.1	USB flash.....	47
6.3.1.2	Acknowledgement function	51
6.3.2	Measurement programs.....	53
6.3.2.1	Channel settings.....	55
6.3.2.2	Scaling analog sensors (strain gage, potentiometer, standard signal sensors).....	56
6.3.2.3	Inverting measurement signals	56
6.3.2.4	Configuring sensors fitted with burster TEDS	57
6.3.2.5	Potentiometric sensors.....	57

6.3.2.5.1	Sensors that output a standard signal.....	60
6.3.2.5.2	Strain gage sensors	62
6.3.2.5.3	Piezoelectric sensors (option)	65
6.3.2.6	Measurement mode.....	69
6.3.2.6.1	Sampling the measurement channels.....	70
6.3.2.6.2	Measurement curve reference	71
6.3.2.6.3	Curve recording, return point.....	76
6.3.2.6.4	Start/Stop mode	78
6.3.2.7	Configuring the evaluation.....	79
6.3.2.7.1	Window.....	79
6.3.2.7.2	Trapezoid window	84
6.3.2.7.3	Threshold.....	88
6.3.2.7.4	Envelope.....	91
6.3.2.7.5	Tolerance band for evaluation elements	96
6.3.2.8	Online switching points.....	98
6.3.2.9	Sensor test	100
6.3.2.10	User-defined values.....	101
6.3.2.11	External memory	104
6.3.3	Channel settings (global)	104
6.3.4	Assignment of the PLC in-/outputs	105
6.3.4.1	PLC outputs.....	105
6.3.4.2	PLC inputs	107
6.3.5	Order sheet	108
6.3.6	Fieldbus.....	110
6.3.6.1	PROFIBUS settings (option).....	111
6.3.6.2	PROFINET settings (option).....	112
6.3.6.3	EtherNet/IP settings (option)	113
7	Numerical test operation and diagnostics.....	114
7.1	Numerical test operation – Live sensor values.....	116
7.2	Numerical test operation - Tare	116
7.3	Numerical test operation – PLC signals	117
7.4	Error messages when the unit is powered up	118
7.5	LED status	119
7.6	LOG file from the DIGIFORCE® 9311.....	119
8	Retrieving measurement curves and measurement results	121
8.1.1	Laboratory mode.....	121
8.1.1.1	Configuring laboratory mode	123
8.1.1.2	Displaying the measurement data	129
8.1.1.3	Graph.....	131
8.1.2	Reading the data logger.....	132
8.1.3	Measurement mode DigiControl	134
8.1.3.1	General settings – Measurement mode	135

8.1.3.2	Data logging contents and documentation parameters for measurement mode	136
8.1.3.3	Starting measurement mode	137
9	Data backup	139
9.1	Creating a data backup – Download	140
9.2	Writing a data backup to the DIGIFORCE [®] 9311 - Upload	141
10	Signal timing diagrams	142
10.1	Selecting a measurement program	142
10.1.1	Changing the measurement program without program acknowledgement	142
10.1.2	Changing the measurement program with program acknowledgement	143
10.2	Starting a measurement	144
10.2.1	Measurement without measurement-data logging	144
10.2.2	Measurement with measurement-data logging	145
10.2.3	Measurement using data logging on USB stick (READY control enabled)	146
10.3	External tare	147
10.3.1	Without tare warning	147
10.3.2	With tare warning	148
10.4	Online signals	149
10.4.1	Window evaluation with online signal	149
10.4.2	Online switching signals S1 to S6	150
10.4.2.1	Switching signals for X-channel with "Absolute" reference	150
10.4.2.2	Switching signals for X-channel with "Trigger" reference	151
10.4.2.3	Switching signals for Y-channel	152
10.5	Acknowledgement function	153
10.5.1	Example of an NOK evaluation for the following configuration	153
10.5.2	Example of an NOK evaluation (without acknowledgement)	154
10.5.3	Example of an OK evaluation (without acknowledgement)	155
10.6	External actuation of a statistics reset	156
10.7	External actuation of a sensor test	157
11	Customer Services for your DIGIFORCE[®] 9311	158
11.1	Firmware update	158
11.2	Fieldbus firmware update	162
12	Technical data	164
12.1	Electromagnetic compatibility	164
12.1.1	Interference immunity	164
12.1.2	Interference emission	164
13	Accessories available	165
13.1	Software	165
14	Disposal	166



1 For your safety

The following symbols on the DIGIFORCE® 9311 and in this operation manual warn of hazards.

1.1 Symbols used in this manual

1.1.1 Signal words



The following signal words are used in the operation manual according to the specified hazard classification.

	DANGER
High degree of risk: indicates a hazardous situation which, if not avoided, will result in death or serious injury.	
	WARNING
Moderate degree of risk: indicates a hazardous situation which, if not avoided, may result in death or serious injury.	
	CAUTION
Low degree of risk: indicates a hazardous situation which, if not avoided, could result in minor or moderate injury.	
NOTICE	
Property damage to the equipment or the surroundings will result if the hazard is not avoided.	

Note: It is important to heed these safety notices in order to ensure you handle the DIGIFORCE® 9311 correctly.

IMPORTANT: Follow the information given in the operation manual.

1.1.2 Pictograms

Symbol	Description
	Electric shock hazard
	Electrostatic discharge. Do not touch! Take precautionary measures against static discharge.
	Observe the advice for protecting the instrument.

1.2 Symbols and precautionary statements on the instrument

Symbol	Description
	Hazard warning Disconnect the power plug before opening – Follow safety instructions – Professional servicing only
Warning ! To prevent electrical shock do not open device.	Warning of electrical shock hazard Do not open the unit.
To prevent fire replace only with same type and rating of fuse !	Warning of fire hazard Always replace the fuse with a fuse of the same type and rating.

1.2.1 Conventions used in the instruction manual

Designation	Description
[Text]	Buttons on the touchscreen display
"Term"	Terms used in the instrument menus

2 Introduction

IMPORTANT: Read the operation manual carefully before using the equipment, and keep for future reference.

2.1 Intended use

The DIGIFORCE® 9311 is an instrument that is designed to monitor repetitive production processes. Its core function is to record and analyze process signals representing physical variables between which there is a defined relationship, for instance recording a curve of force, pressure or torque plotted against displacement, angle or time. Graphical evaluation elements such as windows, trapezoids, thresholds or envelopes are used to analyze the resultant curve. The analysis result is classified as "OK" or "NOK" (Not OK) and output at various interfaces.

The DIGIFORCE® 9311 is NOT intended as a safety device. For instance it is not suitable as an emergency device for shutting down a press if the pressing force exceeds a threshold value.

2.2 Customer Service

2.2.1 Customer service department

For repair inquiries, please telephone our Service department on +49-7224-645-53, or email: service@burster.com (Germany only). If you are outside Germany, you should contact your burster agent (see also www.burster.com).

Please have the serial number to hand. The serial number is essential to establishing the definite technical status of the instrument and providing help quickly. You will find the serial number on the type plate of the DIGIFORCE® 9311.

2.2.2 Contact person

If you have any questions relating to the DIGIFORCE® 9311, please go directly to burster praezisionsmesstechnik gmbh & co. kg, or if outside Germany, please contact your burster agent (see also www.burster.com).

Head office

burster praezisionsmesstechnik gmbh & co kg
Talstr. 1 – 5
76593 Gernsbach
Germany

Telephone: +49-7224-645-0

Fax: +49-7224-645-88

Email: info@burster.com

2.3 Download the test certificate

You have the option to download the test certificate for your DIGIFORCE® 9311 online. To do this, you need to register at <http://www.burster.com/en/registration/>. You can then download the test certificate directly by entering the serial number.

2.4 Ambient conditions

2.4.1 Storage conditions

The following requirements must be met when storing the DIGIFORCE[®] 9311:

- Store at temperatures between 0 °C ... +60 °C
- The unit must be packed in clean packaging
- Store in a dry environment
- No condensation

2.4.2 Operating conditions

The following requirements must be met when operating the DIGIFORCE[®] 9311:

- Always operate indoors
- Maximum height above sea level 2000 m
- Operate at temperatures between +5 °C ... +40 °C, ideally +23 °C
- Humidity: 80 % up to +31 °C, decreasing linearly above that temperature to 50 % at Tmax, no condensation
- Class of protection: 1
- Transient overvoltage category: CAT II
- Potential with respect to ground: ≤ 12 VDC between analog ground and ground
- Supply voltage: 20 ... 30 VDC / 7 – 25 W

Note: Avoid condensation after transportation or storage of the DIGIFORCE[®] 9311.

2.4.3 Restrictions on use

The DIGIFORCE[®] 9311 does not pose a hazard if used within its specification and in accordance with the safety regulations.

The manufacturer does not accept liability for any personal injury or property damage arising from misinterpretation of measurement results.

Note: The DIGIFORCE[®] 9311 is not intended as a substitute for safety devices and protective equipment. Use safety devices and protective equipment.

2.4.4 Cleaning

	 DANGER
	Electrical shock hazard Disconnect the DIGIFORCE® 9311 from the power supply before cleaning.

Disconnect the DIGIFORCE® 9311 from the power supply and use a slightly damp cloth for cleaning the unit.

	NOTICE
	Do not immerse the DIGIFORCE® 9311 in water or hold it under running water. Do not use strong cleaning agents as these may damage the DIGIFORCE® 9311. Use a slightly damp cloth to clean the DIGIFORCE® 9311.

2.5 Personnel

Personnel must be familiar with the relevant regulations. They must follow these regulations. Only trained personnel who are familiar with the applicable safety regulations are permitted to operate the DIGIFORCE® 9311.



burster is happy to provide your operating personnel with training on the DIGIFORCE® 9311. To find out more, please look at our range of services at www.burster.com.

2.6 Contents of pack

The following components are supplied:

- DIGIFORCE® 9311
- Operation manual including burster software DVD
- Warranty document
- Test certificate

2.7 Unpacking

	 <p>DANGER</p> <p>Never connect the DIGIFORCE[®] 9311 if it shows signs of damage incurred in transit. Only ever use the DIGIFORCE[®] 9311 under the conditions specified in this operation manual.</p>
---	---

Inspect the DIGIFORCE[®] 9311 for damage. If you suspect that the unit has been damaged during shipping, notify the delivery company within 72 hours.

The DIGIFORCE[®] 9311 should be shipped only in its original packaging or in packaging capable of providing an equivalent degree of protection.

2.8 Warranty

burster praezisionsmesstechnik gmbh & co kg provides a manufacturer's warranty for a period of 24 months after delivery.

Any repairs required during this time will be made without charge. This does not include damage arising from improper use.

Please note the following when sending the DIGIFORCE[®] 9311 in for repair:

- If there is a problem with the DIGIFORCE[®] 9311, please attach a note to the DIGIFORCE[®] 9311 case summarizing the fault.
- Technical specifications subject to change at any time without notice.
We also state explicitly that we do not accept liability for consequential damage.
- The DIGIFORCE[®] 9311 must always be dispatched in suitable packaging.

2.9 Conversions and modifications

Note: The warranty shall be deemed void **immediately** if you open or dismantle the DIGIFORCE[®] 9311 during the warranty period.

The DIGIFORCE[®] 9311 does not contain any parts that are intended to be serviced by the user. Only the manufacturer's own qualified personnel are permitted to open the DIGIFORCE[®] 9311.

It is not permitted to make any changes to the DIGIFORCE[®] 9311 without the written agreement of burster praezisionsmesstechnik gmbh & co kg. burster praezisionsmesstechnik gmbh & co kg does not accept liability for damages or injury if this condition is disregarded.

3 Principles of design and operation

Please refer to the DIGIFORCE® 9311 data sheet for full details of dimensions, weight, degree of protection etc.

3.1 Range of functions

The DIGIFORCE® 9311 monitors processes in which precisely defined functional relationships need to be demonstrated between two measured quantities. These measured quantities are recorded synchronously during the manufacturing process or subsequent functional testing to produce a measurement curve, which is then assessed using graphical evaluation elements. Once the internal evaluation is complete, the calculated evaluation results are provided at the external interfaces. The DigiControl PC software can then retrieve the measurement curve for data logging and reporting if required. A powerful real-time operating system optimizes processes in the DIGIFORCE® 9311 to achieve an extremely fast evaluation cycle. It typically takes just 25 ms to deliver the global OK or NOK evaluation result, which can then be analyzed by a higher-level controller.

In addition to the traditional evaluation windows with defined entry and exit sides, with the DIGIFORCE® 9311 you can also use thresholds, trapezoids of type X or Y and envelopes as graphical evaluation elements.

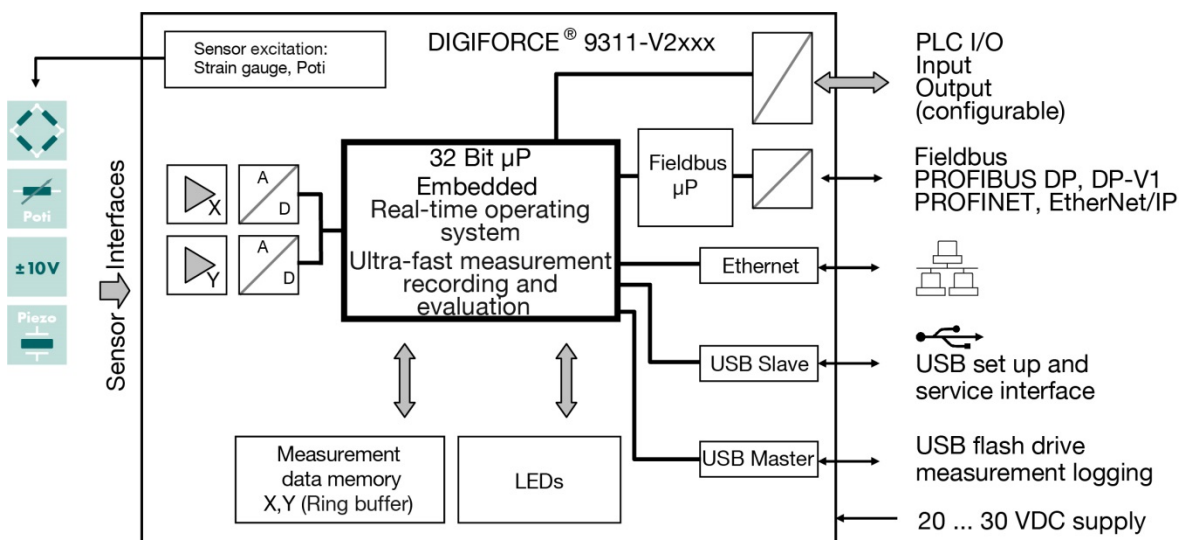

Diagram 1: Block diagram of the DIGIFORCE® 9311 cabinet module

3.2 Versions

Please refer to the data sheet for details of the different versions. You can obtain the latest data sheet and additional information on the DIGIFORCE® 9311 from <http://goo.gl/muUe7D> or simply use the QR code below:



DIGIFORCE[®] model 9311

3.3 Power supply





The DIGIFORCE[®] 9311 can be operated with a voltage of 20 to 30 VDC / 7 – 25 W.

3.4 Sensors suitable for use with the DIGIFORCE[®] 9311

The DIGIFORCE[®] 9311 can process signals from a huge range of sensor technologies.

Note: Section 6.3.2.1 “Channel settings” on page 55 explains how to assign physical connectors, and hence the respective sensors, to the measured curve (X/Y curve)

DIGIFORCE[®] 9311 works with these sensor technologies:

Symbol	Type	Connector
	Strain gage sensors	B
	Potentiometers	A
	Sensors with standard signal (process signal)	A, B
	Piezoelectric (option)	B*

*Connector B (Piezoelectric) is available as an option.

Note: There is no strain-gage connection when the optional piezo connection is used.

Examples of connected sensors

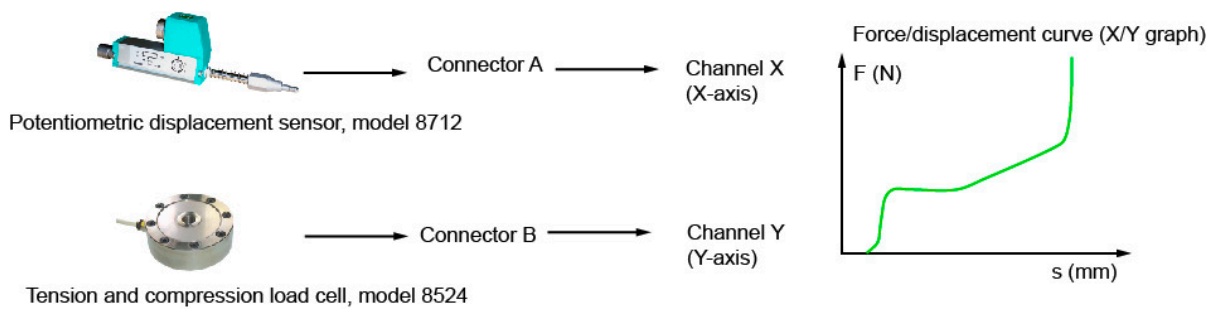

Diagram 2: Examples of connected sensors

3.4.1 Automatic sensor identification (burster TEDS)

DIGIFORCE® 9311 uses the burster TEDS (Transducer Electronic Data Sheet) to provide automatic sensor recognition, i.e. the DIGIFORCE® 9311 reads the relevant sensor specification from an EEPROM, fitted in the sensor plug, and can then use this data to perform the necessary channel configuration automatically. The memory chip in the sensor plug is programmed when the sensor is first ordered or subsequently calibrated. The burster TEDS feature is only available for sensors with a permanently fitted connecting lead.

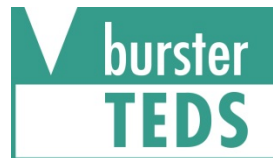

Diagram 3: burster TEDS label

3.5 Recording measurement curves

An external control signal or an internal condition triggers the measurement. On receiving this active start condition, the DIGIFORCE® 9311 immediately starts writing the values measured by the sensors as X/Y value pairs to the measured-value memory. The DIGIFORCE® 9311 stops the measurement again when a stop condition is met.

Then the DIGIFORCE® 9311 immediately evaluates the recorded measurement curve. In this evaluation, the DIGIFORCE® 9311 checks whether the measurement curve satisfies all the defined graphical evaluation elements. If so, the measurement is assessed to be OK. If, however, there is at least one infringement, the DIGIFORCE® 9311 gives the measurement an NOK evaluation.

As soon as it has completed the evaluation, the DIGIFORCE® 9311 refreshes the measurement mode display and updates the control signals at the PLC interface. The DigiControl PC software can then retrieve the measurement curve for data logging and reporting if required.

3.5.1 Starting / stopping a measurement

You can use various events as the start signal and stop signal, which can be mutually independent.

Starting a measurement

- External control signal.
- Measured value goes above or below a defined X-value (e.g. a displacement value).
- Measured value goes above or below a defined Y-value (e.g. a force value) (not for piezoelectric sensors).

Stopping a measurement

- External control signal.
- Measured value goes above or below a defined X-value (e.g. a displacement value).
- Measured value goes above or below a defined Y-value (e.g. a force value).
- Time (timeout).
- Configurable number of recorded measured values reached.

3.5.2 Sampling the measurement signals

DIGIFORCE® 9311 supports three different sampling methods, which you can enable in combination. In addition to time-based sampling, you can record the pairs of measured values using a configurable Delta(Δ)X value or Delta(Δ)Y value. This allows the DIGIFORCE® 9311 to use only the optimum number of sample points to record a curve accurately and to reproduce it in full. For instance, it uses only a very few points to measure a force/displacement curve that has a low gradient over the initial travel region of the joining process followed by a steep section as it rises into an end-point force.

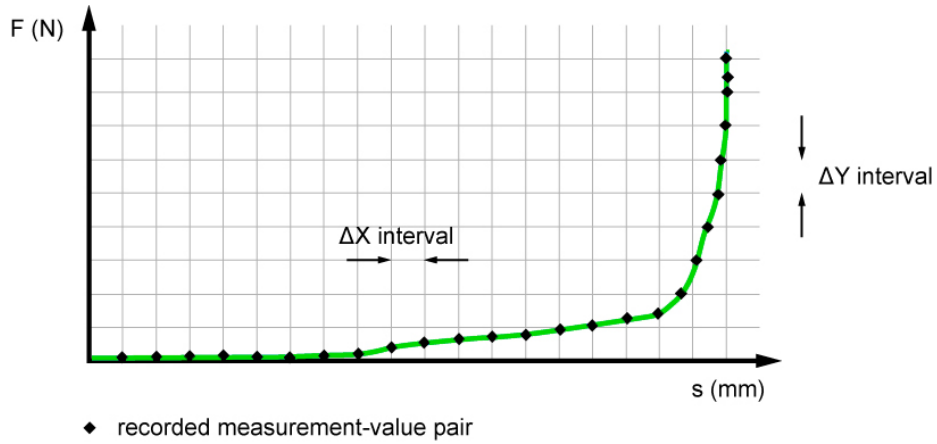

Diagram 4: Sampling the measurement signals

3.5.3 Defining an X-axis reference

A measurement curve recorded by the DIGIFORCE® 9311 can be based on a choice of references. For instance for a force/displacement curve, the reference can be a particular displacement value. In a conventional application using an "Absolute" reference, the reference point equals the zero point of the position measurement system. Component tolerances or tolerances in tool changeover systems, workpiece mounts etc. result in variation (spread) in the X-values of the measurement curves. This spread might mean that the result from an evaluation element falls in the NOK category. You can eliminate this spread, however, by using a different reference point.

The DIGIFORCE® 9311 provides the following reference options:



- Absolute
- Final force
- Crossing reference line
- Crossing trigger threshold.

3.6 Evaluation methods

As a universal evaluation tool, the DIGIFORCE® 9311 provides a wide selection of configurable graphical evaluation elements. These can be used for OK/NOK classification of a vast range of curve types.

In addition to traditional windows with defined entry and exit sides, the DIGIFORCE® 9311 also provides thresholds, trapezoids of type X or Y and envelopes as graphical evaluation elements. These give you the extra flexibility you need to evaluate practically any type of signal curve.

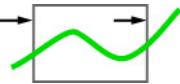
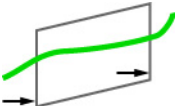
Summary of the evaluation elements

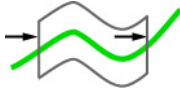
Symbol	Evaluation element	Max. number
	Window with configurable entry/exit sides, online signal, entry/exit, min/max value	3
	X or Y trapezoid, configurable entry/exit side	2
	X or Y threshold, configurable crossing	2
	Envelope, configurable entry/exit side	1

3.7 Tare function

The tare function can be used to correct static offsets on the sensor channels. For instance you can correct a varying background load caused by a tool changeover system by running the tare function before every measurement. You can also set a warning limit for sensors, which can be used to detect signs of wear in good time and hence avoid any associated measurement errors. If the current measured value exceeds the stored warning limit while the tare function is active, the DIGIFORCE® 9311 issues the "OUT_WARNING_TARE" warning signal.

Options for initiating the tare function

- Manually in the "Numerical test operation" menu of DigiControl PC software
- Automated trigger via the control interface (PLC I/O or Fieldbus "IN_TARE_X", "IN_TARE_Y", "IN_TARE_X+Y")
- Automatically when a measurement starts

3.8 Sensor test

Regular checking of sensors plays a crucial role in the test reliability of a quality control system. In these checks, defined physical quantities are applied to the sensors. The DIGIFORCE® 9311 then evaluates the resultant electrical signals.

An example of how to calibrate these values is to use a feed unit to move into a reproducible position such as the top limit of travel for the press, or up to a master part. In this position, the DIGIFORCE® 9311 captures the channel measurements and applies tolerance limits to these measured values.

Then measurements are performed again precisely at these positions in the regular sensor test. The sensor test, initiated by a PLC signal ("IN_STEST"), checks the sensor values at these positions. If a sensor lies outside the tolerance range, DIGIFORCE® 9311 sends a warning signal to the PLC ("OUT_OK_STEST" = 0). This practically eliminates any erroneous measurements from faulty or drifting sensor systems.

3.9 Online switching points

The online switching points can be used to output in real time a signal at the control interface (PLC I/O or Fieldbus) if a set signal level is exceeded. Switching points S1 to S6 are provided for this function. You are free to choose their switching polarity and can assign them to the X and Y measurement channels as you wish.

When assigning a switching signal to the X-channel, you can choose to refer the set level (threshold value) to the absolute zero point ("Absolute" reference) or to a relative zero point ("Trigger" reference).

These switching points are updated in real time both during and outside an active measurement cycle.

3.10 Visualizing, signaling and transferring results

The DIGIFORCE® 9311 shifts immediately into the evaluation phase at the end of a measurement. In this phase, the unit checks whether the measurement curve meets the conditions of the graphical evaluation elements such as a window or envelopes. If the conditions are met, the DIGIFORCE® 9311 assesses the measurement as OK. If, however, it identifies an infringement of the graphical evaluation elements, it assesses the measurement as NOK.

In parallel with updating the global OK/NOK result at the end of the measurement, the DIGIFORCE® 9311 also refreshes the active measurement window in the display. In addition, it updates the relevant PLC I/O signals and also any status signals and result values at the Fieldbus interface. Once a measurement has finished, you can retrieve curve data and measurement results via the communications interfaces (Ethernet and USB). You can also use the DigiControl PC software to log this data automatically after every measurement. This process can also run synchronously on more than one DIGIFORCE® 9311 unit at once. In addition, you can log the data on a USB stick.

4 Controls and connections

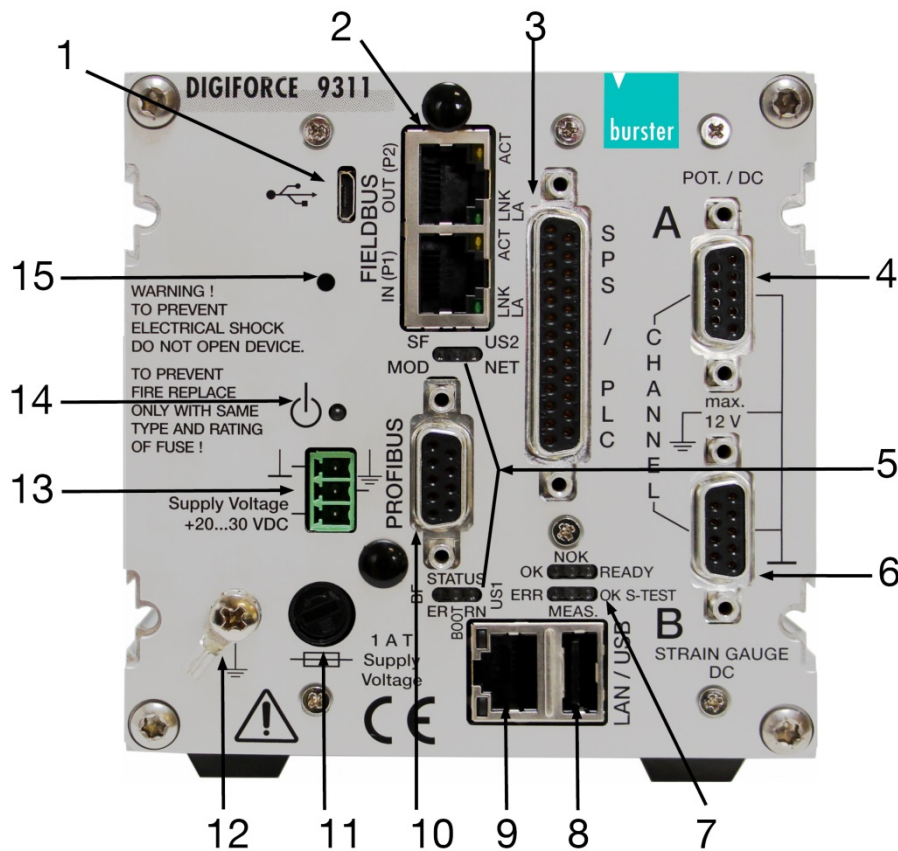

Diagram 5: Front view of the DIGIFORCE® 9311

Label	Description
1	USB service port
2	Ethernet-based Fieldbus ports (optional)
3	PLC I/O signals
4	A, standard analog connection (potentiometer, standard signal)
5	Fieldbus status LEDs Note: The LEDs for the Fieldbus interfaces are described in the relevant supplementary documentation (e.g. the DIGIFORCE® 9311 PROFIBUS manual).
6	B, standard analog connection (strain gage, standard signal or piezoelectric input (optional))
7	Status LEDs
8	USB port (USB host port)
9	Ethernet port
10	PROFIBUS DP-V0 / DP-V1 (optional)

11	Fuse
12	Ground connection terminal
13	Connector for DC supply
14	"Power" status LED
15	Reset button

IMPORTANT: When replacing the fuse, first make sure that the DIGIFORCE® 9311 is completely disconnected from the supply. To guarantee complete isolation, you must remove the power supply disconnecting plug from the DIGIFORCE® 9311.

Note: The LEDs for the Fieldbus interfaces are described in the relevant supplementary documentation (e.g. the DIGIFORCE® 9311 PROFIBUS manual).

4.1 Status LED (normal operation)

Note: Please see section 7.4 "Error messages when the unit is powered up" on page 118 for details of the status LED indicators during the DIGIFORCE® 9311 boot-up phase.

LED	Meaning
OK	Evaluation result OK
NOK	Evaluation result NOK
READY	Ready signal for measurement (see also section 10 "Signal timing diagrams" on page 142)
ERR	Fault / Error Possible causes: <ul style="list-style-type: none"> • Measurement started when READY = 0 • Measurement-channel overdrive • Error during USB-stick data logging You can also find further details in section 7 "Numerical test operation and diagnostics" on page 114.
MEAS.	Measurement in progress
OK S-TEST	Result of sensor test (see also section 6.3.2.9 "Sensor test" on page 100)

4.2 Grounding and shielding

The DIGIFORCE® 9311 is earthed (grounded) via the PE conductor of the IEC cold connector (Class I appliance) see section 4 "Controls and connections" on page 20.

Use a suitable connecting cable with a dual-shield construction (aluminum foil plus braided shield) for connecting sensors, communication interfaces and Fieldbus interfaces and for the PLC I/O signal control lines. Ideally you should connect sensors using burster connecting cables and with a minimum length of cable. When using mains leads from other manufacturers or an international mains connection, you must ensure that there is a proper connection to earth.

We strongly recommend the following

- Use metallic or metal-plated connecting plugs. Connect the braided shield of shielded cables to the connector casing.
- As a general rule, keep sensor connecting leads as short as possible, and especially for piezoelectric sensors.
- It is best to use a suitable connecting cable from the sensor manufacturer for connector B (piezoelectric).
- When using control lines from remote PLC systems, make sure all the system components are suitably earthed.
- When using detachable extension leads, make sure the shielding is continuous.
- Position signal lines away from supply lines (in particular when laying cables near servomotors).

DIGIFORCE® model 9311

4.3 Connections

4.3.1 Connection for the DC power supply

The supply voltage must lie in the range 20 to 30 VDC.

Pin assignment for the power supply disconnecting plug (supplied with the equipment):

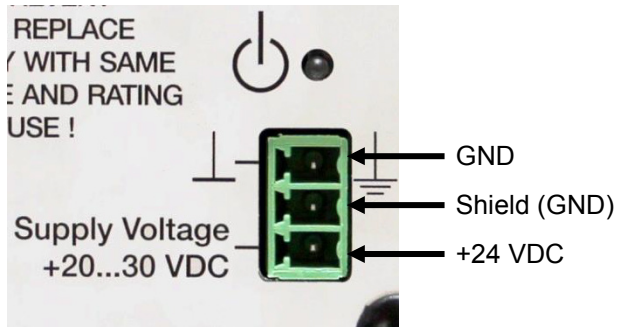

3-pin terminal block header MC1.5/3-G-3.81 in accordance with EN-VDE standard.

4.3.2 PLC I/O signals

	<h2 style="margin: 0;">NOTICE</h2>
	<p>+24 VDC supply voltage! Only connect devices that are designed for this supply voltage.</p>

The PLC control signals (inputs and outputs) are provided on the DIGIFORCE® 9311 at the 25 pin D-SUB port. The signals are opto-isolated from the controller core and work with positive logic. An external 24 VDC supply is needed to operate the PLC outputs; the DIGIFORCE® 9311 does not provide an auxiliary voltage.

The PLC outputs of the DIGIFORCE® 9311 use sourcing logic (p-switching).

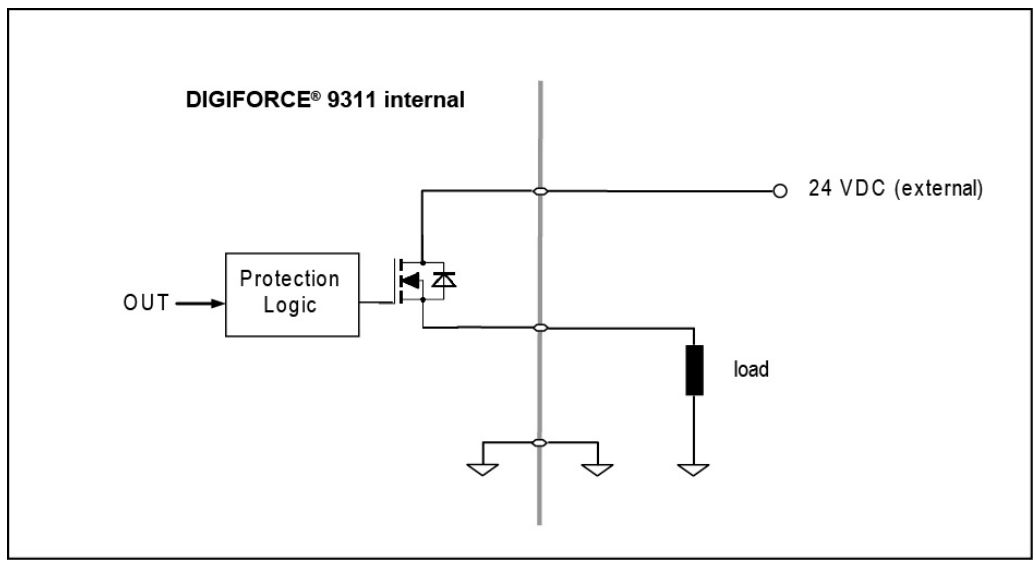

Diagram 6: PLC output

Pin assignment for the 25 pin D-SUB socket (female)

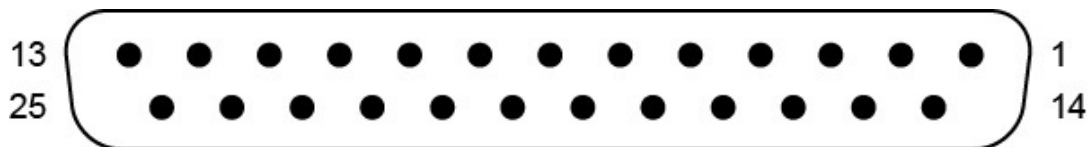

Diagram 7: 25 pin D-SUB socket (female)

Note: Note that some PLC inputs and some PLC outputs can be configured with a different signal assignment (for further details, please see section 6.3.4.1 “PLC outputs” on page 105 and section 6.3.4.2 “PLC inputs” on page 107).

Note: The following pin assignments show the factory settings.

PIN	Signal name	Configurable	Assignment
1	+24 VDC	-	24 VDC external voltage supply
2	GND_EXT	-	PLC-GND reference potential +24VDC_EXT
3	IN_START	No	External measurement start / stop
4	IN_TARE_X	Yes	Tare the X-channel
5	IN_RES_STAT	Yes	Reset the statistics
6	IN_STEST	Yes	Run the sensor test
7	IN_STROBE	No	Adopt the measurement program no. from IN_PROG[]
8	IN_PROG0	No	Bit 0 of measurement program no. (binary coded)
9	IN_PROG1	No	Bit 1 of measurement program no. (binary coded)
10	IN_PROG2	No	Bit 2 of measurement program no. (binary coded)
11	IN_AUTO	No	DIGIFORCE® 9311 is held in measurement mode (used only in DIGIFORCE® 9311 with touchscreen)
12	IN_PROG3	No	Bit 3 of measurement program no. (binary coded)
13	OUT_BUZZER	No	PWM signal for external buzzer
14	OUT_READY	No	Ready signal for measurement
15	OUT_OK	No	Evaluation result OK
16	OUT_NOK	No	Evaluation result NOK
17	OUT_NOK_ONL	No	Online NOK, live signal from the "Window" evaluation element
18	OUT_S1	No	Online switching signal S1
19	OUT_S2	No	Online switching signal S2
20	OUT_OK_STEST	Yes	Result of sensor test
21	OUT_STROBE	Yes	Acknowledge signal for measurement program

DIGIFORGE[®] model 9311

PIN	Signal name	Configurable	Assignment
			selection
22	OUT_PROG0	Yes	Bit 0 of echoed measurement program
23	OUT_PROG1	Yes	Bit 1 of echoed measurement program
24	OUT_PROG2	Yes	Bit 2 of echoed measurement program
25	OUT_MEAS_ACT	Yes	Measurement in progress

4.3.3 Connector A – Potentiometer, Standard signal

!	CAUTION
	<p>+5 VDC sensor excitation voltage Only connect sensors that are designed for this excitation voltage.</p>

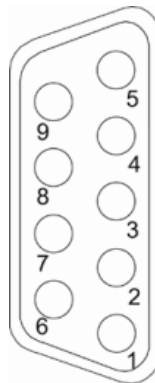

Diagram 8: Connector A

PIN	Assignment
1	+ excitation potentiometer
2	+ sense (sense leads)
3	+24 VDC / 150 mA transmitter supply*
4	- sense (sense leads)
5	- excitation potentiometer
6	+ signal (input)
7	burster TEDS: 1-Wire® EEPROM
8	Ground, transmitter supply*
9	- signal (input)
housing	shield (ground potential)

* You can switch the transmitter supply on/off in the parameter settings.
The transmitter supply is factory-set to off.
Power is always supplied to both D-SUB 9-pin connectors; switching on just one is not possible.

Note: The 1-Wire® interface uses the shield as the ground potential.

DIGIFORCE® model 9311

4.3.3.1 Connector A: connecting potentiometric sensors

You can connect potentiometric sensors to connector A.

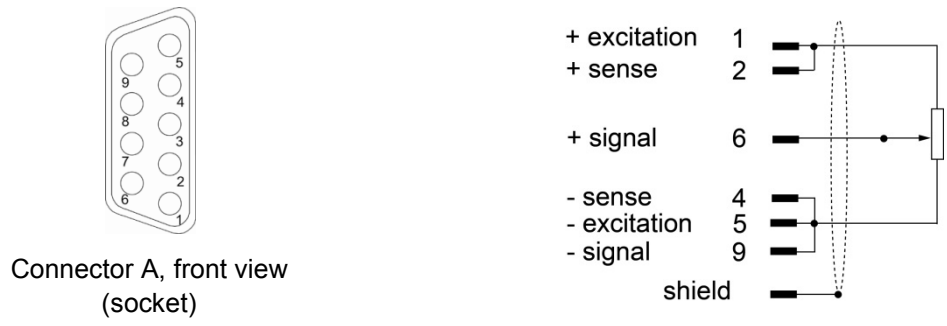

Diagram 9: Connector A: potentiometric sensors

4.3.3.2 Connector A: connecting potentiometric sensors fitted with burster TEDS

You can connect potentiometric sensors fitted with burster TEDS to connector A.

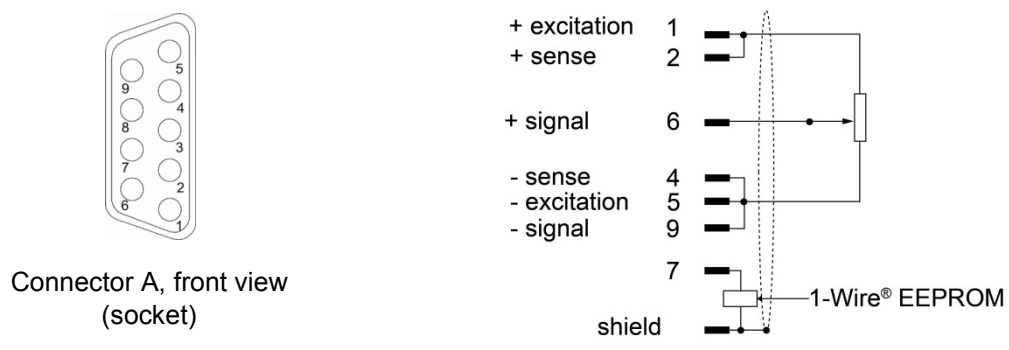

Diagram 10: Connector A: potentiometric sensors fitted with burster TEDS

4.3.3.3 Connector A: connecting standard-signal sensors

You can connect standard-signal sensors to connectors A and B.

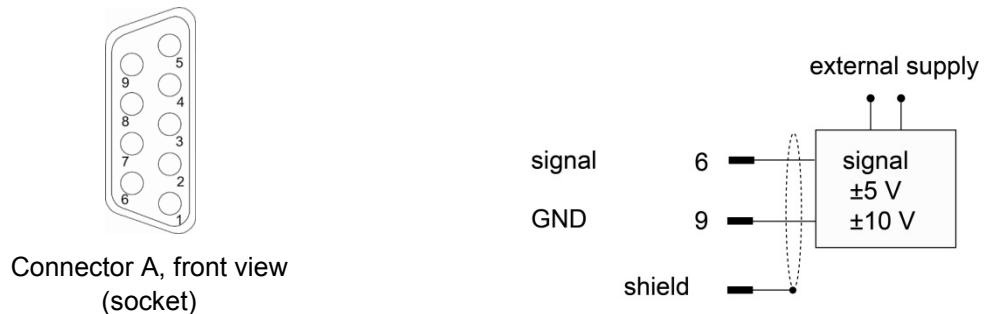
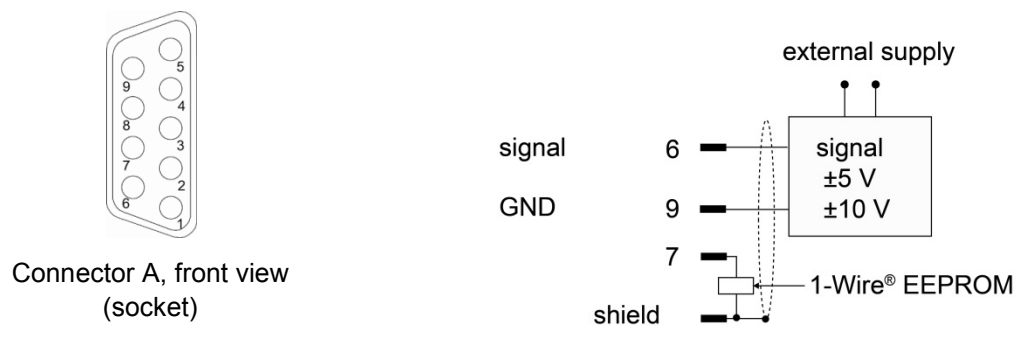

Diagram 11: Connector A: standard-signal sensors

4.3.3.4 Connector A: connecting standard-signal sensors fitted with burster TEDS

You can connect standard-signal sensors to connectors A and B.



4.3.4 Connector B – strain gage sensors, standard-signal sensors

	<h3>CAUTION</h3>
	<p>+5 VDC sensor excitation voltage Only connect sensors that are designed for this excitation voltage.</p>

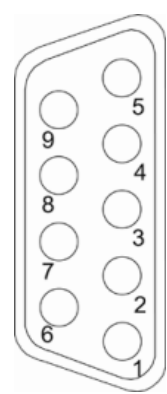

Diagram 13: Connector B

PIN	Assignment
1	+ excitation for strain gage, standard-signal sensor
2	+ sense (sense leads)
3	+24 VDC / 150 mA transmitter supply*
4	- sense (sense leads)
5	- excitation for strain gage, standard-signal sensor
6	+ signal (input)
7	burster TEDS: 1-Wire® EEPROM
8	Ground, transmitter supply*
9	- signal (input)
housing	shield (ground potential)

* You can switch the transmitter supply on/off in the parameter settings.
The transmitter supply is factory-set to off.
Power is always supplied to both D-SUB 9-pin connectors; switching on just one is not possible.

Note: The 1-Wire® interface uses the shield as the ground potential.

4.3.4.1 Connector B: connecting strain gage sensors without sense leads

You can connect strain gage sensors without sense leads to connector B.

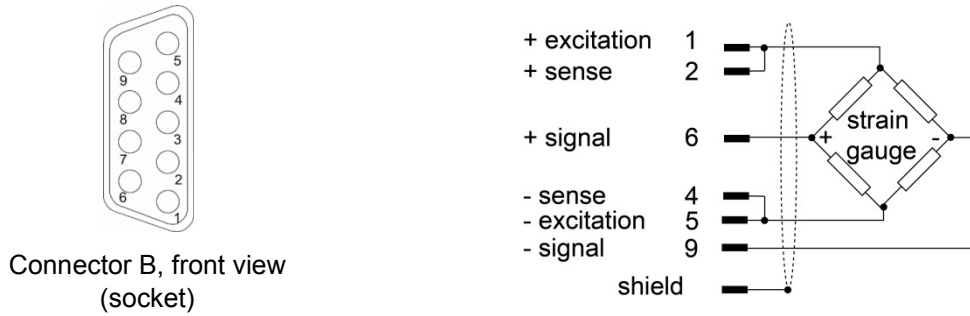

Diagram 14: Connector B: strain gage sensors without sense leads

4.3.4.2 Connector B: connecting strain gage sensors without sense leads, fitted with burster TEDS

You can connect strain gage sensors without sense leads, fitted with burster TEDS to connector B.

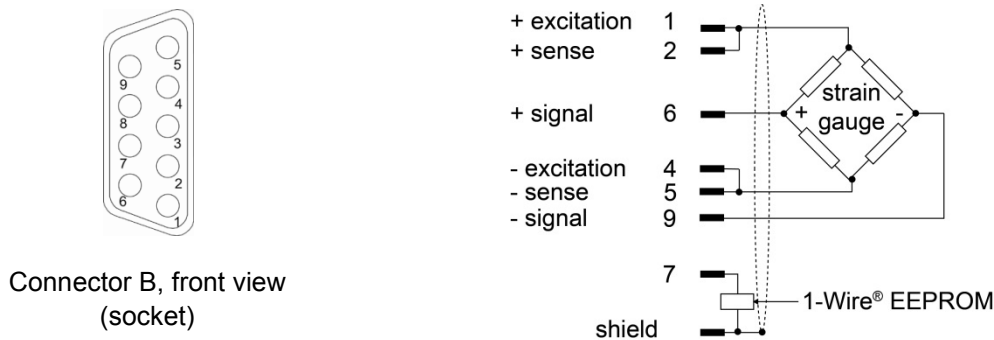

Diagram 15: Connector B: strain gage sensors without sense leads, fitted with burster TEDS

4.3.4.3 Connector B: connecting strain gage sensors with sense leads

You can connect strain gage sensors with sense leads to connector B.

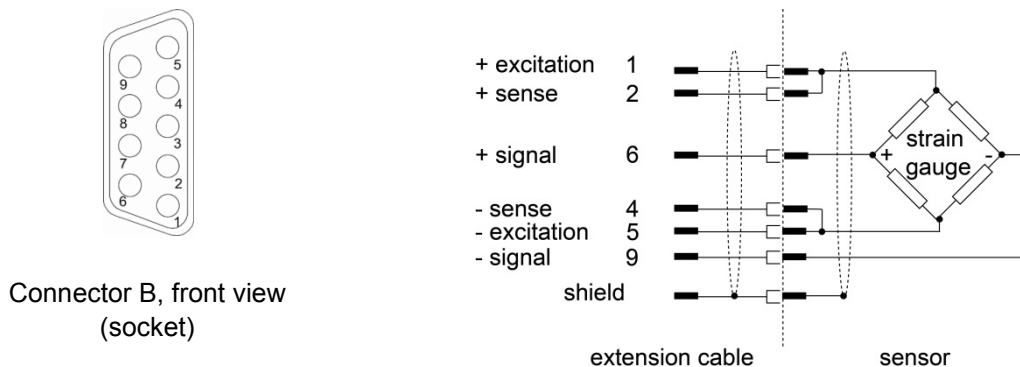

Diagram 16: Connector B: strain gage sensors with sense leads

Insert the short circuit connection between the sense lines and the excitation lines as close as possible to the sensor. For this situation, we recommend the burster extension lead, part no. 99209-609A-xxxxxxx (e.g. 099209-609A-0150030 for fixed installations, length 3 m).

DIGIFORGE[®] model 9311

4.3.4.4 Connector B: connecting strain gage sensors with sense leads, fitted with burster TEDS

You can connect strain gage sensors with sense leads, fitted with burster TEDS to connector B.

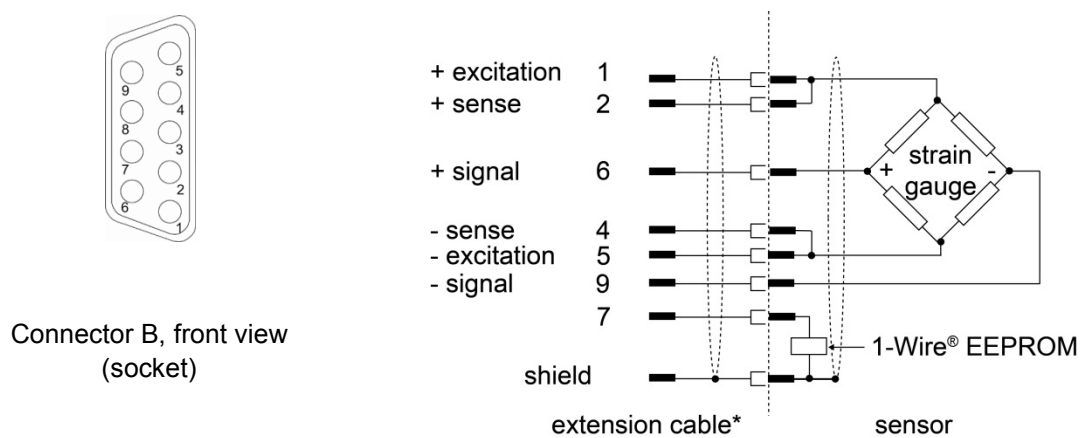

Diagram 17: Connector B: strain gage sensors with sense leads, fitted with burster TEDS

*Please ensure, that the 1-Wire[®] signal has to be connected when using an extension cable.

4.3.4.5 Connector B: connecting standard-signal sensors

You can connect standard-signal sensors to connectors A and B.

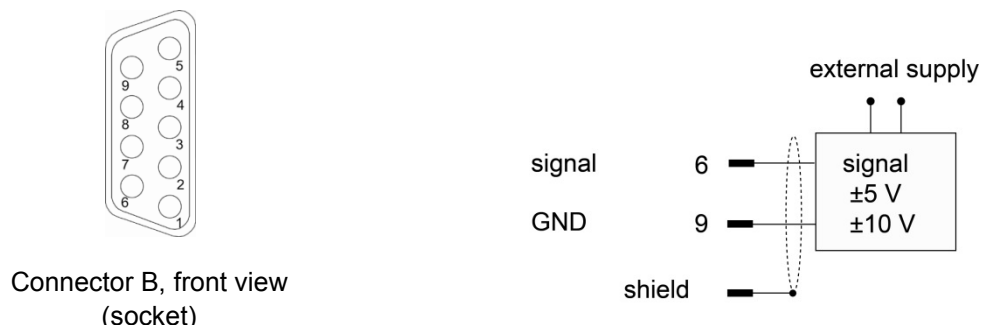

Diagram 18: Connector B: standard-signal sensors

4.3.4.6 Connector B: connecting standard-signal sensors fitted with burster TEDS

You can connect standard-signal sensors to connectors A and B.

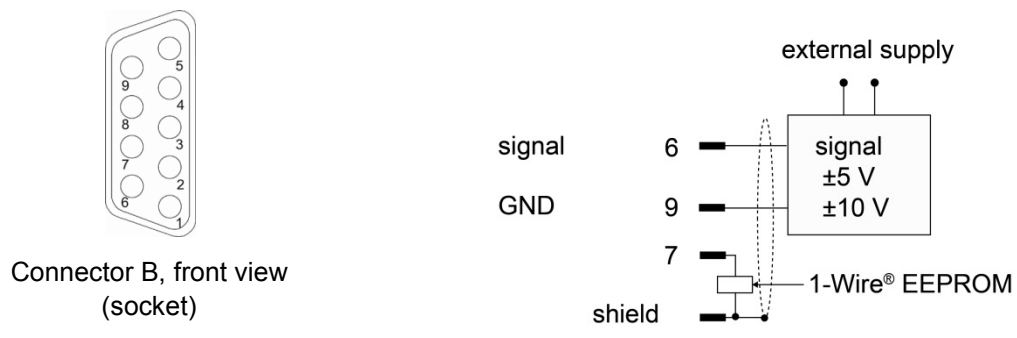

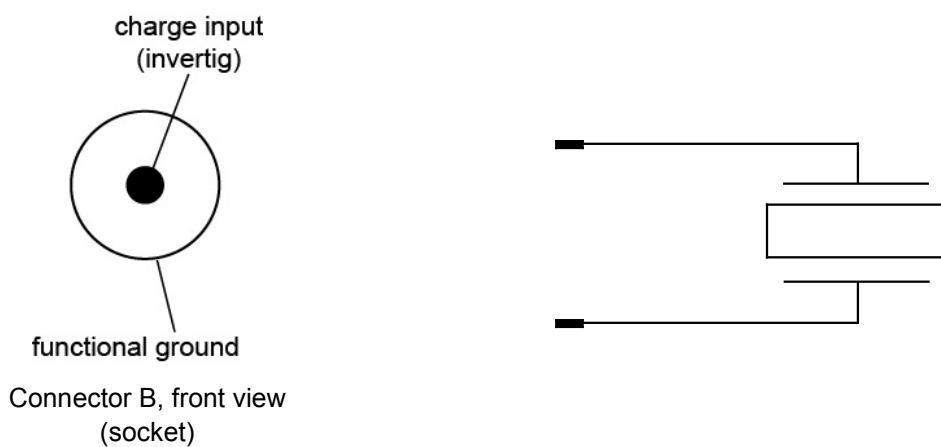

Diagram 19: Connector B: standard-signal sensors fitted with burster TEDS

4.3.4.7 Connector B: connecting a piezoelectric sensor (option)

	 WARNING
	<p>Electrostatic discharge. Do not touch!</p> <p>Electrostatic discharge can damage the piezoelectric input. Take precautionary measures against static discharge.</p>

You can connect piezoelectric sensors to connector B (standard BNC socket).



Note: For this function, your DIGIFORCE® 9311 must be equipped with the optional piezoelectric input. With this option, connector B for a strain-gage or standard-signal input is no longer provided. The DIGIFORCE® 9311 does not support the TEDS function for the optional piezoelectric input.

DIGIFORCE® model 9311

4.3.5 USB service port

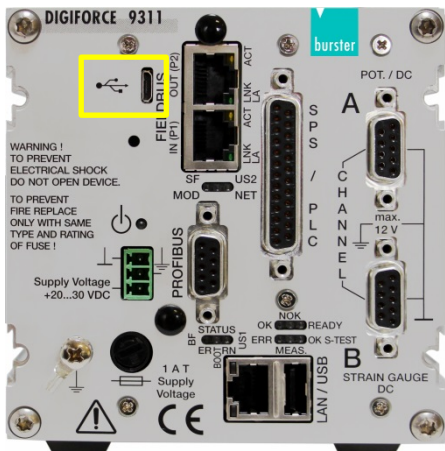

Diagram 21: USB service port

The USB service port is located on the front of the unit (type Micro-B).

You can use the USB service port to configure all the settings for the DIGIFORCE® 9311 and to retrieve all the measurement and evaluation results including the complete set of measurement curves. The DIGIFORCE® 9311 and DigiControl PC software (part no. 9311-P101 or 9311-P100 PLUS version) can communicate with each other via the USB service port. Use a USB-A plug to Micro-B connecting cable (burster part number 9900-K358, length 1.8 m) to connect to a PC USB port. The protocol specification for the USB service port is provided in a separate document: "The DIGIFORCE® 9311 interface manual".

Note: We recommend using the Ethernet port if you want to provide a permanent computer connection e.g. for long-term, continuous data logging.

USB interface parameters

A PC detects the USB port of the DIGIFORCE® 9311 as a virtual COM port. The drivers needed for this port are installed with the DigiControl PC software. If you want to use PC communication without the DigiControl PC software, you can install the necessary drivers from the DVD supplied (the drivers are also available from www.burster.com).

Interface parameters for the virtual COM port of the PC

Baud rate	921600 (fixed setting)
Data bits	Fixed data format, 8 bits (fixed setting)
Stop bits	Number of stop bits: 1 (fixed setting)
Parity	None (fixed setting)
Blockcheck	Disabled (fixed setting)

4.3.6 Ethernet port

You can use the Ethernet port to configure all the settings for the DIGIFORCE® 9311 and to retrieve all the measurement and evaluation results including the complete set of measurement curves. The DIGIFORCE® 9311 and DigiControl PC software (part no. 9311-P101 or 9311-P100 PLUS version) can communicate with each other via the Ethernet port. You can specify Ethernet port parameters such as the IP address in the "Station properties" menu (see section 6.2.2 "Ethernet interface configuration" on page 42).

Use a standard patch cable of category "Cat5e" or above for connecting to an Ethernet network.

The protocol specification for the Ethernet port is provided in a separate document: "The DIGIFORCE® 9311 interface manual".

Note: DIGIFORCE® 9311 cabinet modules can be configured only via the PC communication ports. Since it is always necessary to configure the Ethernet port for use, we recommend always using the USB port to perform the necessary basic configuration.

4.3.7 USB host port (memory-stick data logging)

The USB host port (USB type A) is located directly beside the Ethernet LAN socket. When you plug in a USB flash drive and enable data logging, an entry containing result data (but not the measurement curve) is made in the plain-text *.csv file for each measurement (you can find further details in section 6.3.1.1 "USB flash" on page 47).

4.3.8 PROFIBUS interface

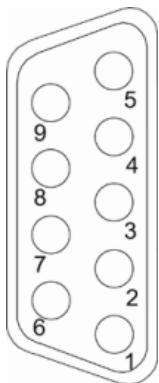

Diagram 22: PROFIBUS interface

PIN	Assignment
1	Shield
2	NC
3	RxD/TxD-P
4	NC
5	PROFIBUS GND
6	VP +5V (bus termination)
7	NC
8	RxD/TxD-N
9	NC

Details of the PROFIBUS interface are provided in a separate document: "The DIGIFORCE® 9311 PROFIBUS manual".

4.3.9 Ethernet-based Fieldbus interface (dual RJ45)

Details of the available Ethernet-based Fieldbus interfaces are provided in a separate document (can be obtained from info@burster.com or by phoning +49-7224-645-0).

5 Using the DIGIFORCE® 9311 for the first time



DANGER

Never switch on the DIGIFORCE® 9311 if it shows signs of damage incurred in transit. Only ever use the DIGIFORCE® 9311 under the conditions specified in this operation manual.

NOTICE



No particular action needs to be taken before using the DIGIFORCE® 9311 for the first time, although the DIGIFORCE® 9311 must have reached thermal equilibrium. If the unit has been stored in a location that is colder than where the unit will be operated, the DIGIFORCE® 9311 must remain switched off for a suitable length of time before use because of potential condensation. Select an installation location that does not expose the DIGIFORCE® 9311 to extreme temperatures (please refer to the operating temperature range in the DIGIFORCE® 9311 data sheet) or to temperature fluctuations. Keep the DIGIFORCE® 9311 away from moisture, dust, oils, organic solvents, aerosols and strong vibrations; do not install in the immediate vicinity of powerful electrical interference sources. In particular, when connecting the sensors for use, do not lay the connecting cables close to sources of electromagnetic interference.

5.1 35 mm DIN rail mounting/removal

The DIGIFORCE® 9311 is mounted on a 35 mm rail to DIN EN 60715.

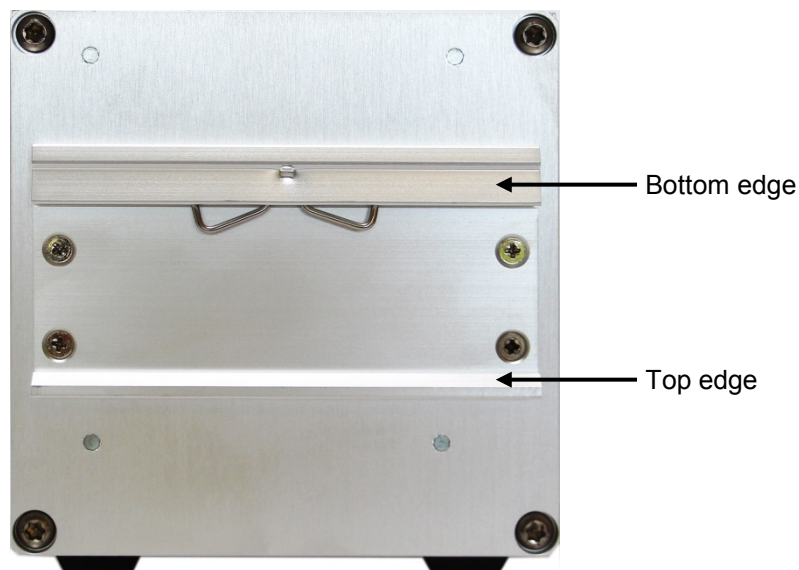

Diagram 23: Rear view of DIGIFORCE® 9311

DIGIFORCE[®] model 9311

Mounting



This is how it works

- 1 Rest the top edge of the fastening on the rail.



- 2 Push the DIGIFORCE[®] 9311 from the front against the rail until you can hear the catch click into place.
- 3 Pull the DIGIFORCE[®] 9311 slightly to test it is fixed securely in place.

Removal



This is how it works

- 1 Gently push the DIGIFORCE[®] 9311 downwards at the back until the bottom edge disengages.
- 2 Then tilt the DIGIFORCE[®] 9311 slightly upwards and lift the top edge off the rail.

5.2 DigiControl PC software

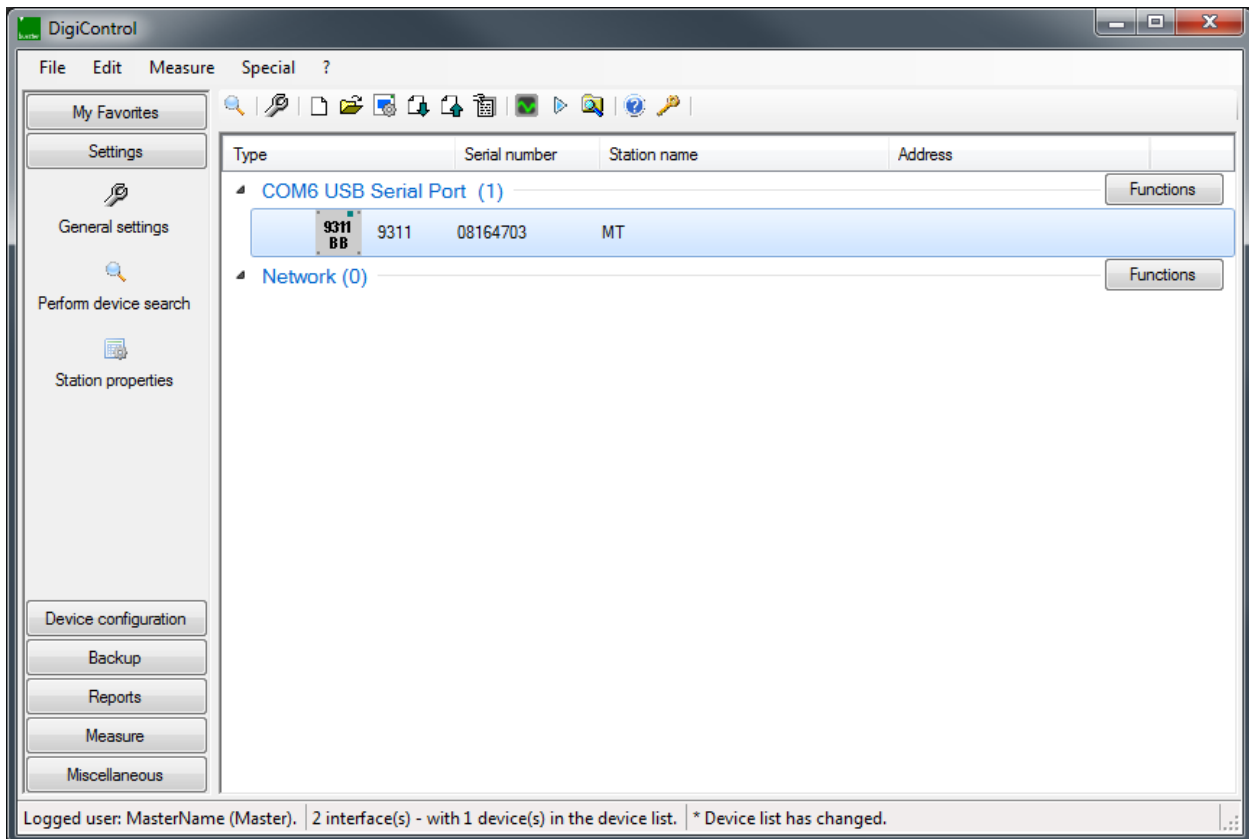

Diagram 24: DigiControl PC software

The DigiControl PC software is needed for configuring the DIGIFORCE® 9311. This software is included with the DIGIFORCE® 9311. Alternatively, you can also download the DigiControl PC software at www.burster.com.

The DIGIFORCE® 9311 cabinet module can be configured only via interfaces (USB or Ethernet). Using the DigiControl PC software, you can not only perform the entire device configuration but also backup your settings (for information on data backups see section 9 “Data backup” on page 139). In laboratory operating mode, measurement data can be read manually and the data printed out or saved in a log file.

Installation instructions and system requirements for the DigiControl PC software are given in the software documentation held on the burster DVD supplied with the equipment.

Note: When more than one DIGIFORCE® 9311 is supplied, for instance for a multichannel application, the number of copies of the DigiControl PC software (including data cables) that are supplied does not equal the number of DIGIFORCE® 9311.

Note: You can access the main functions of the DigiControl PC software from the Quick Launch bar on the left or from the Menu bar at the top.

5.2.1 Controls and symbols

This is a list of the common control buttons and icons displayed in the DigiControl PC software:

Icon	Meaning
	This icon always takes you to the Online Help facility of the DigiControl PC software
☑ / ☐	Checkbox enabled / disabled
⦿ / ○	Radio button enabled / disabled

6 Configuring the unit

The unit is configured entirely via the USB or Ethernet interfaces or alternatively via the optional Fieldbus interfaces. For the configuration, use the DigiControl PC software supplied with the unit (base version).

6.1 Establishing a connection to the DigiControl PC software (USB or Ethernet)



This is how it works

- 1 To establish a connection to the DigiControl PC software after installation, connect the DIGIFORCE® 9311 to the PC via USB or Ethernet.
- 2 Run the DigiControl PC software.
- 3 Click "Perform device search".

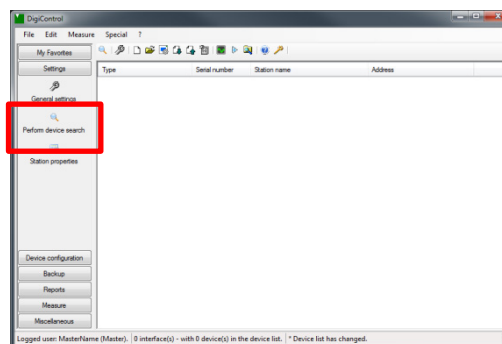

- 4 Enter the relevant search parameters. A device search is always performed via USB (the virtual COM port to the DIGIFORCE® 9311 is always displayed). For a device search via Ethernet, you can click the **[Extended device search]** button to make detailed settings for the network you are using.

Note: When connecting to a new DIGIFORCE® 9311 for the first time, we recommend using the USB port to transfer to the DIGIFORCE® 9311 any LAN configuration needed (IP address).

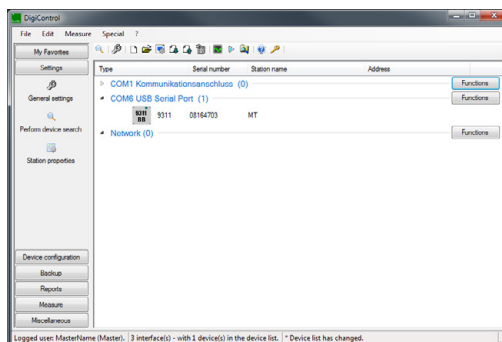
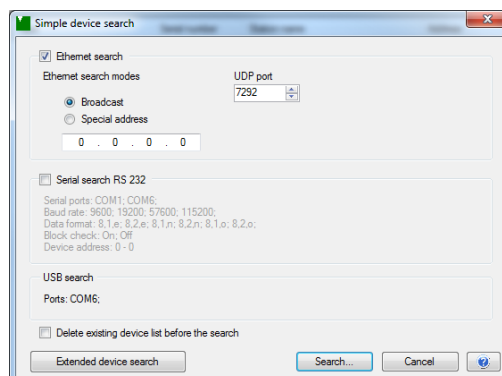

DIGIFORCE® model 9311

6.2 DIGIFORCE® 9311 device information (Properties)

6.2.1 Station properties

The "Station properties" menu contains information on the serial number, software versions, calibration date and Fieldbus option. You can also enter here a station name, which can be useful, for instance, in measurement data documentation. The "Communication" tab (see section 6.2.2 "Ethernet interface configuration" on page 42) can be used for parameterizing the Ethernet interface. The licensed PLUS version 9311-P100 additionally displays the "Measurement mode" tab in which you can make settings and define documentation parameters for automatic measurement data acquisition (Measurement mode function).



This is how it works

- 1 Double-click on the DIGIFORCE® 9311 in the device list. The "Station properties 'XXXX' " window opens.
- 2 Enter the parameters you require.

IMPORTANT: Under "Station properties", you can define whether you want the channel settings to apply globally to all the measurement programs, or specifically to each measurement program, i.e. set separately for each measurement program. Please note that if the "global" setting is enabled, then any change will overwrite the settings for all the measurement programs. If you want the settings to be adopted for all the measurement channels, enable the "Global channel settings" checkbox. For further details on the available channel settings, please refer to section 6.3.2.1 "Channel settings" on page 55.

- 3 Click on "Communication" to activate the settings for the Ethernet port and any access restrictions (Host IP).

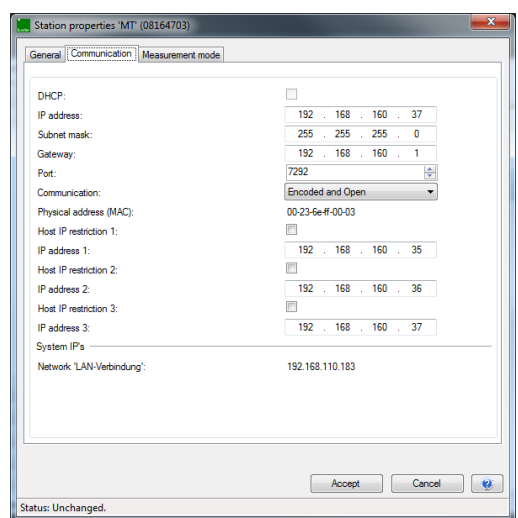
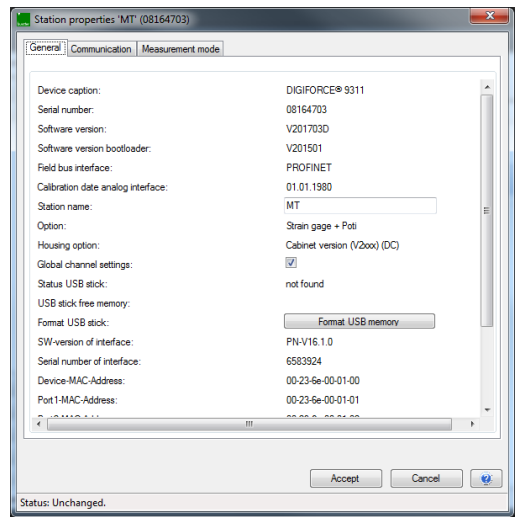

Parameters in "Station properties"

Station name	Free text field
Global channel settings	<p>Enable / disable</p> <p>Enabling this checkbox means that the channel settings are adopted for all the measurement programs.</p> <p>IMPORTANT: Please note that if the global setting is enabled, then any change will overwrite the settings for all the measurement programs.</p>

6.2.2 Ethernet interface configuration

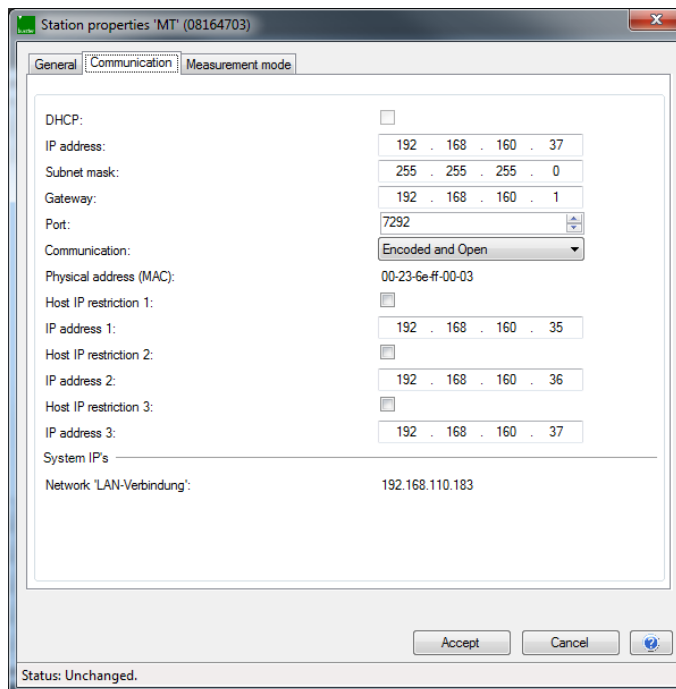

Diagram 25: Station properties – Ethernet interface

Parameters in "Ethernet interface (UDP/IP)"

DHCP	<p>Enabled / disabled</p> <p>When DHCP is enabled (Dynamic Host Configuration Protocol), the DIGIFORCE® 9311 is assigned an IP address, subnet mask and gateway by the DHCP server.</p>
IP address	<p>Enter here the IP address for the DIGIFORCE® 9311. You can obtain a valid address from your network administrator.</p> <p>Note: The IP address must be unique within a network.</p>
Subnet mask	<p>Enter the subnet mask here. You can obtain a valid mask from your network administrator. The subnet mask defines whether an IP address lies in the same sub-network.</p>
Gateway	<p>Enter the gateway here. You can obtain a valid address from your network administrator. Connections to other networks can be made via the gateway.</p>

DIGIFORCE[®] model 9311

Port	<p>This is where you select the UDP port (default: 7292).</p> <p>Note: If a firewall is used, the UDP protocol must be enabled on this port. On a PC, only one active UDP connection (socket) is allowed on the same port.</p>
Communication	<p>Ethernet communication. Select either "Encoded" or "Encoded and open".</p> <p>"Encoded": UDP datagrams are transmitted in encoded form.</p> <p>"Encoded and open": UDP datagrams are transmitted in encoded and un-encoded form.</p>
Host IP restriction 1-3	<p>An active Host IP restriction can be used to restrict access to up to three specified host addresses. This can be useful for preventing unwanted access attempts, for example attempts to change the DIGIFORCE[®] 9311 configuration. The Host IP restriction is factory set to disabled.</p>
IP address 1-3	<p>IP addresses for the various host systems</p>

6.2.3 Station properties for station - Measurement mode

Note: The "Measurement mode" tab in the "Station properties" menu only appears in the licensed PLUS version 9311-P100 of the DigiControl PC software.

You can use the "Measurement mode" tab for automatic logging of measurement data (only for the PLUS version 9311-P100), where you can set what measurement data you wish to log and in what format, and also additional documentation parameters such as component and batch names or a part ID. Some of these documentation parameters can also be entered by automated transfer, for instance via the DIGIFORCE® Fieldbus interfaces or via the DigiControl Remote interface (please refer to the relevant supplementary documentation on the Fieldbus interfaces and the DigiControl Remote interface).

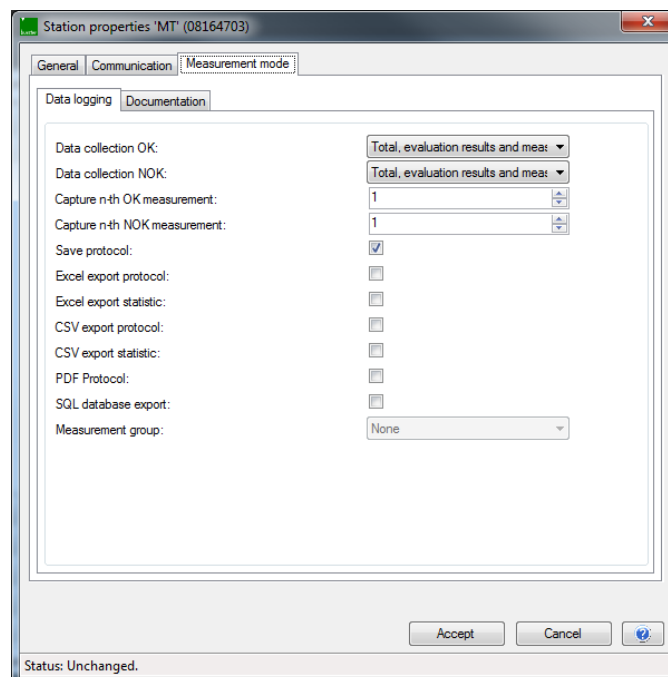

Diagram 26: Station properties – Measurement mode (PLUS version 9311-P100 only)

Note: The Online Help of the DigiControl PC software contains further details on automatic logging of measurement data.

6.3 Device settings

When using the DigiControl PC software for online parameterization of the DIGIFORCE® 9311, you can make practically all the settings in the "Parameterizing" menu. The exceptions are the Ethernet interface settings, defining the use of a global (default) or program-specific measurement channel configuration and setting the station name. You can find further details on these settings in section 6.2 "DIGIFORCE® 9311 device information (Properties)" on page 41.

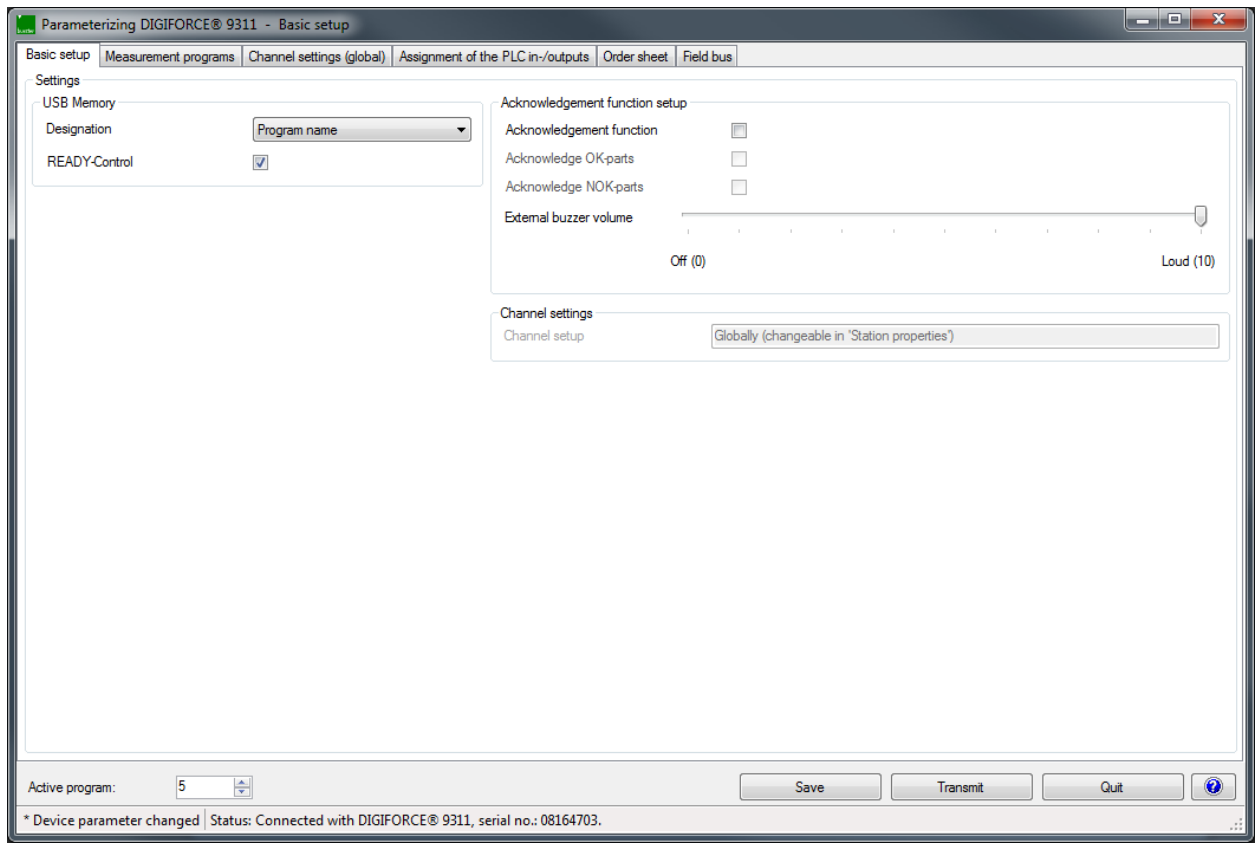

Diagram 27: DigiControl – Parameterizing DIGIFORCE® 9311

You can view or edit the following settings and information in the "Parameterizing DIGIFORCE® 9311" menu:

- Basic setup
- Measurement programs
- Channel settings (global) (not applicable for program-specific channel settings)
- Assignment of the PLC in-/outputs
- Order sheet
- Field bus



This is how it works

- 1 Click on "File" > "Parameterize from device".

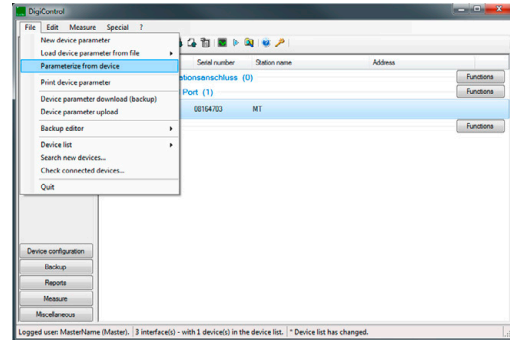

- 2 You are now in the menu "Parameterizing DIGIFORCE® 9311 - Basic setup".

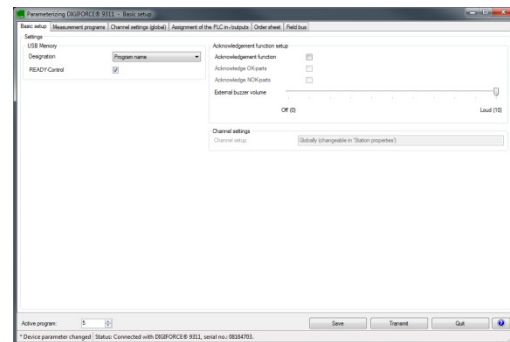

6.3.1 Basic setup

The "Basic setup" tab is where you define the settings for USB-stick data logging and the Acknowledgement function. The Acknowledgement function is normally used only for manual workstations without automation. Combined with the associated PLC inputs/outputs, it can be used, for instance, to control directly OK/NOK indicator lamps, an external buzzer or even a press lock.

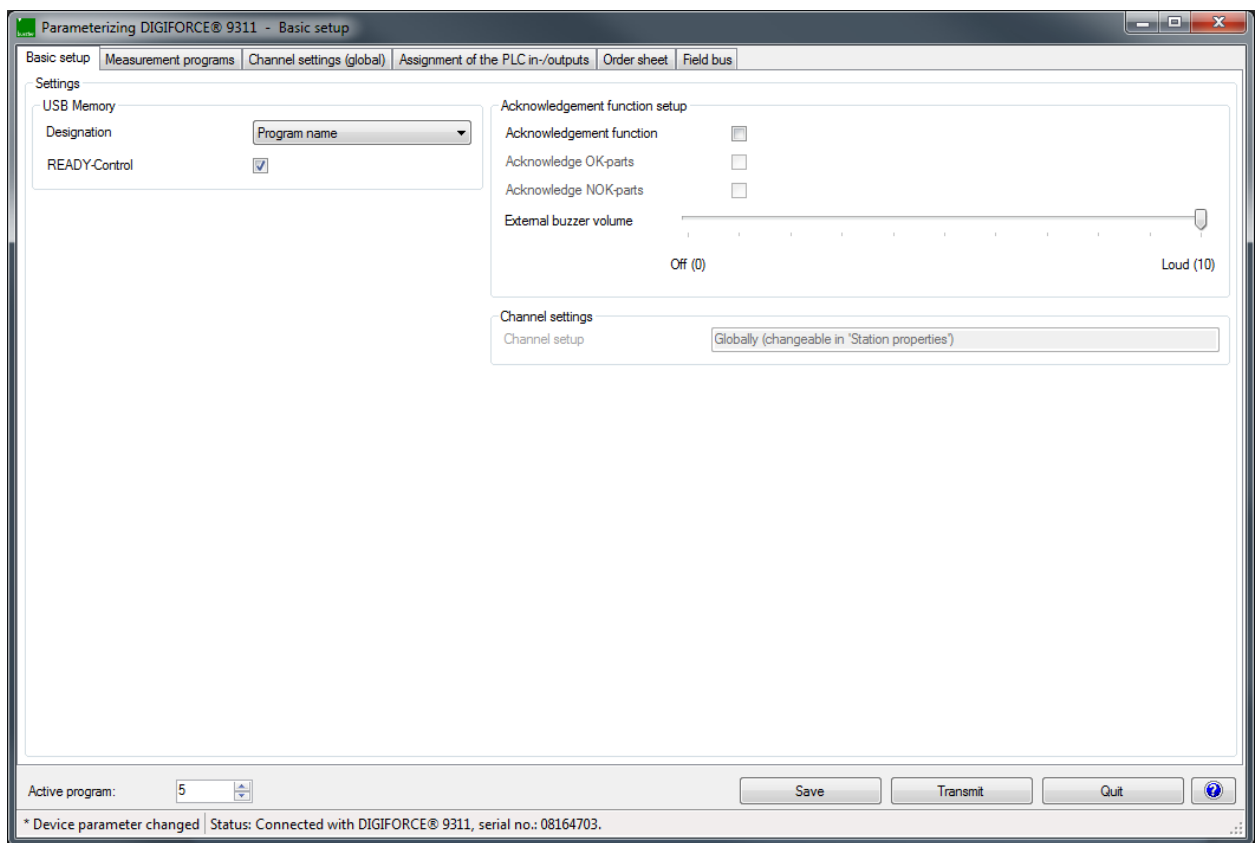

Diagram 28: DigiControl – Parameterizing DIGIFORCE® 9311

6.3.1.1 USB flash

When data logging on a USB flash drive is enabled, a data entry containing result data (but not the measurement curve) is made for each measurement. If you have connected a USB flash drive to the rear USB port of the DIGIFORCE® 9311, the associated information is displayed in the "Station properties" menu. In this menu you can also select the source of the component name and configure the behavior of the "OUT_READY" control signal.

Parameters in "Basic setup – USB Memory"

Designation	Here you can choose whether the program name or order sheet is used as the designation. This designation is used for subsequent identification of the measurement and appears both in the name of the *.csv file on the USB flash drive and inside the file in the "HEADER" as the component name ("Component").
READY control	If you enable this function, the Ready status and the "OUT_READY" control signal is not set until data logging on the USB stick has finished.

Note: You need to enable data logging in each measurement program for which you wish to record the measurement data on USB. For further details, please see section 6.3.2.11 "External memory" on page 104.

Procedure

With USB flash drive data logging enabled, a data entry is made for each measurement. A new file is created when USB flash drive data logging first starts. When the file is created, a "HEADER" is saved in the file. This header is not subsequently checked for plausibility however. The file name, on the other hand, is always checked for validity for subsequent measurements. If it is still valid, the new entry is added to the file. If not, a new file is created. If the file reaches the maximum file size of 25 MB, data is automatically written to a new file.

Storage location	...\\Data\\<YYYY>\\<MM>\ Key: <YYYY> : year <MM> : month
File type	*.csv (ASCII)
Language	English language only
File name	<Component_Name>~<Batch>#<Sequential_Number> @<9311_Serial_Number><Program_Number>.csv Key: <Component_Name>: Configurable; program name, or component name from order sheet. ~<Batch>: Batch from order sheet; not included if a batch reference is not entered. #<Sequential_Number>: A sequential number with "#" prefix for files with the same name; not used if the file name is unique.
Maximum file size	25 MB

File structure - HEADER

The "HEADER" is created just once when the file is created, but not checked again for plausibility.

The "HEADER" contains the following information:

	A	B
1	HEADER	
2	Station name	ST-A-70
3	Device Serial number	931106
4	Component	Lager-N762
5	Meas. Prog-Name	PROG 0
6	Meas-Prog-No.	0
7	Batch	Z987654321A
8	Unit X	mm
9	Unit Y	N
10	Time stamp	2016_02_19_15_14_34
11	FW/Protocol vers.	V201606B/1.01

Diagram 29: Example of "HEADER"

Station name	Station name
Device Serial number	Serial number of the DIGIFORCE® 9311
Component	Component name (if given in the order sheet)
Meas.-Prog-Name	Name of the measurement program
Meas.-Prog-No.	Number of the measurement program
Batch	Batch reference from the order sheet
Unit X	Units for the X-axis
Unit Y	Units for the Y-axis
Time stamp	File-creation date and time stamp (YYYY_MM_DD_hh_mm_ss)
FW/Protocol vers.	Firmware and version code for data logging on USB stick

Serial number	This entry is obtained from "SN1" on the order sheet. Note: Information can be entered in the order sheet via the Fieldbus interfaces. Terminating character: semicolon ";" (0x3B hex)
Piece-Counter	Piece counter in the DIGIFORCE [®] 9311 Terminating character: semicolon ";" (0x3B hex)
General curve data	"General curve data" dataset Xmin, Xmax, Ymin, Ymax, Start, End and Return point, each as a pair of coordinates Delimiting character: " " (0x7C hex) Terminating character: semicolon ";" (0x3B hex)
User defined values	"User-defined values" dataset (see section 6.3.2.10 "User-defined values" on page 101). Delimiting character: " " (0x7C hex) Terminating character: Line Feed "LF" (0x0A hex)

Note: If you require an example of a USB-stick data-logging file, please email info@burster.com.

6.3.1.2 Acknowledgement function

Under "Acknowledgement function setup" you can configure the use of indicator lights and an acoustic signal. You can also specify here that operating personnel must confirm NOK/OK parts. This function is linked to the "OUT_ACK_LOCK" lock output. The DIGIFORCE[®] 9311 can use this lock, for instance, to stop the stroke of a manual press in the event of an NOK evaluation. You can use the slide bar under "External buzzer volume" to increment or decrement the volume level of the external acoustic signal.

You can use the following PLC outputs for the Acknowledgement function:

Parameters in "Basic setup - Acknowledgement function setup"

Acknowledgement function	On / Off	Enabled / disabled The Acknowledgement function can be used to acknowledge a completed measurement and thereby release the device inputs/outputs again for measurements. Additional PLC outputs are also available for controlling direct signaling devices.
Acknowledge OK-parts	On / Off	
Acknowledge NOK-parts	On / Off	
External buzzer volume		Volume level adjustment for the external acoustic signal from "Off (0)" to "Loud (10)".

You can use the following PLC outputs for the Acknowledgement function:

OUT_ACK_OK	Signal for the external "Pass indicator" (measurement OK) If the acknowledgement function for OK parts is enabled, the signal flashes until acknowledged. Acknowledgement sets the PLC output to active (does not flash).
OUT_ACK_NOK	Signal for the external "Fail indicator" (measurement NOK) When an acknowledgement prompt for NOK parts is active, the signal flashes until acknowledged, and the OUT_BUZZER is activated. On acknowledgement, the PLC output OUT_ACK_NOK is set to active (stops flashing) and the buzzer output is deactivated.
OUT_ACK_LOCK	Lock output, e.g. to be used externally to prevent a return stroke
OUT_ACK_ALARM	If the acknowledgement function is enabled and the acknowledge is performed incorrectly, the alarm output is set.
OUT_BUZZER	PWM signal for an external acoustic signal

If the acknowledgement function is enabled, it can be useful to assign the acknowledge action to the PLC inputs:

IN_ACK_OK	Acknowledge input for the "Pass indicator" (measurement OK)
IN_ACK_NOK	Acknowledge input for the "Fail indicator" (measurement NOK)
IN_ACK	Acknowledge input for OK and NOK measurements

Note: You can also find further details on the signal sequences in section 10.5 "Acknowledgement function" on page 153.

6.3.2 Measurement programs

In the "Measurement programs" tab, you can select and configure the relevant measurement program or copy measurement programs.

IMPORTANT: Under "Station properties", you can define whether you want the channel settings to apply globally to all the measurement programs, or specifically to each measurement program, i.e. set separately for each measurement program. Please note that if the global setting is enabled, then any change will overwrite the settings for all the measurement programs. If you want the settings to be adopted for all the measurement channels, enable the "Global channel settings" checkbox. For further details please refer to section 6.2 "DIGIFORCE® 9311 device information (Properties)" on page 41.

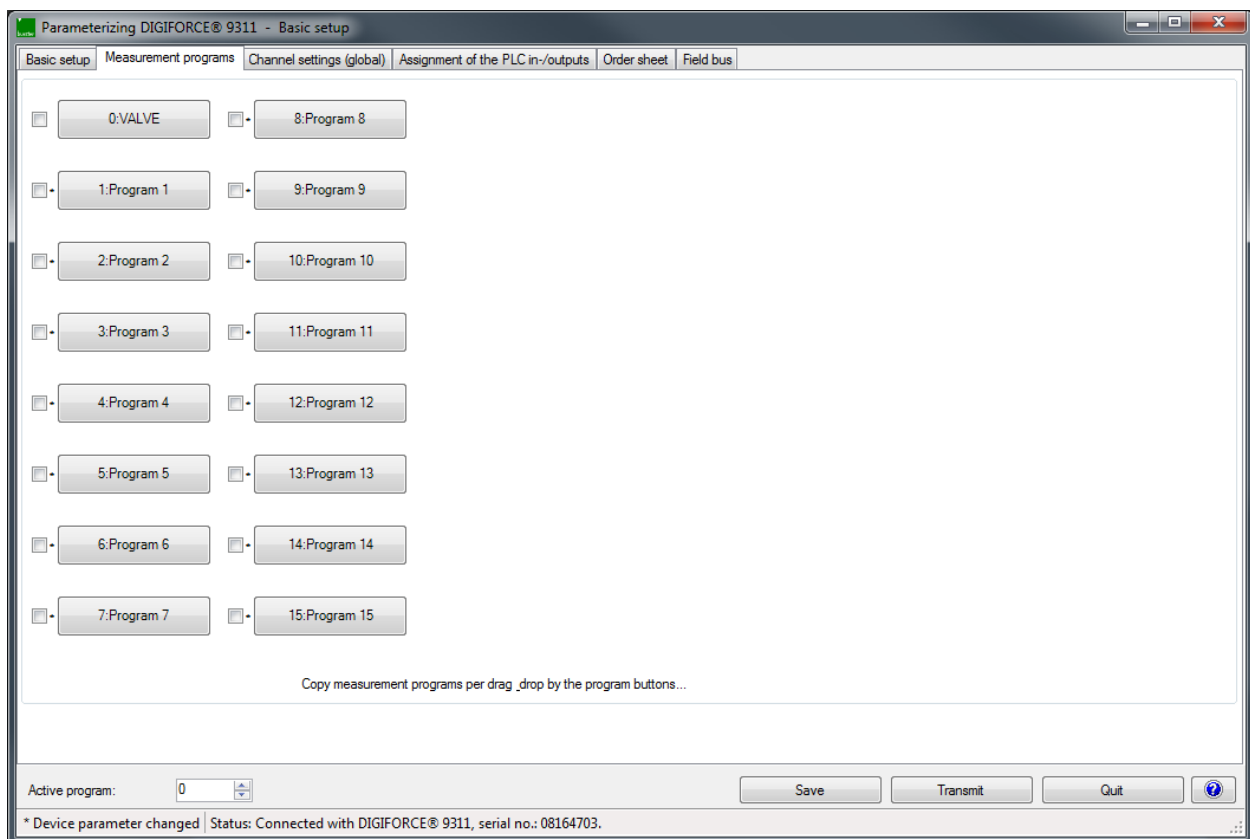

Diagram 30: DigiControl – Measurement programs



This is how it works

- 1 Click on the "Measurement programs" tab.
- 2 Click on [**n:Program n**] to select the measurement program that you want to edit.
- 3 If you want to copy a measurement program, click on the relevant program (**[n:Program n]**) and hold down the mouse button. Drag the measurement program that you want to copy onto the measurement program that you want to overwrite, then release the mouse button.

Note: All the program settings in the destination programs will be deleted and replaced by the source program settings! Therefore you may wish to make a backup of the device settings first (see section 9 "Data backup" on page 139).

You can also copy a measurement program via "Edit" > "Copy measurement program(s) (whole setup)".

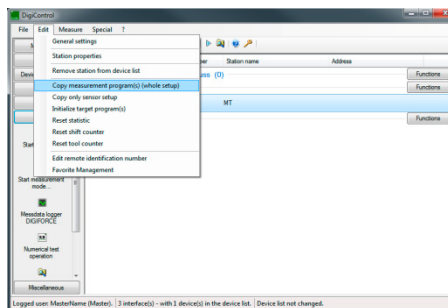

Select the source program that you want to copy, and under "Target program number from" and "Target program number to" specify which measurement programs you want to be overwritten by the source program.

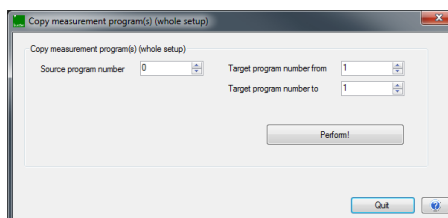

Click [**Perform!**] to copy the measurement program.

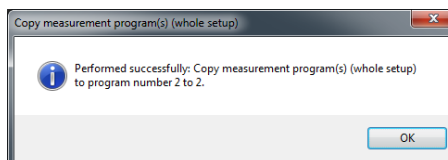

6.3.2.1 Channel settings

IMPORTANT: Under "Station properties", you can define whether you want the channel settings to apply globally to all the measurement programs, or specifically to each measurement program, i.e. set separately for each measurement program. Please note that if the global setting is enabled, then any change will overwrite the settings for all the measurement programs. If you want the settings to be adopted for all the measurement channels, enable the "Global channel settings" checkbox (see section 6.2 "DIGIFORCE® 9311 device information (Properties)" on page 41).

IMPORTANT: If you close the menu when "globally" is set, all the previous program-specific channel settings are lost. The settings from the currently set measurement program are then copied to all the other programs.

Note: If you have enabled the "Global channel settings", a new tab "Channel settings (global)" appears in the menu "Parameterizing DIGIFORCE® 9311 – Basic setup". Make all the settings you require in this tab. The "Channel settings" under "Measurement programs" is then disabled (please also refer to section 6.3.3 "Channel settings (global)" on page 104).

In the "Channel settings" tab, you can assign the physical connectors (connectors A and B) to the active measurement channels X and Y. You can customize this assignment, i.e. you can assign the active measurement channels (X-axis and Y-axis) to whichever connector you require. Instead of the connectors, you can also define a pure time axis.

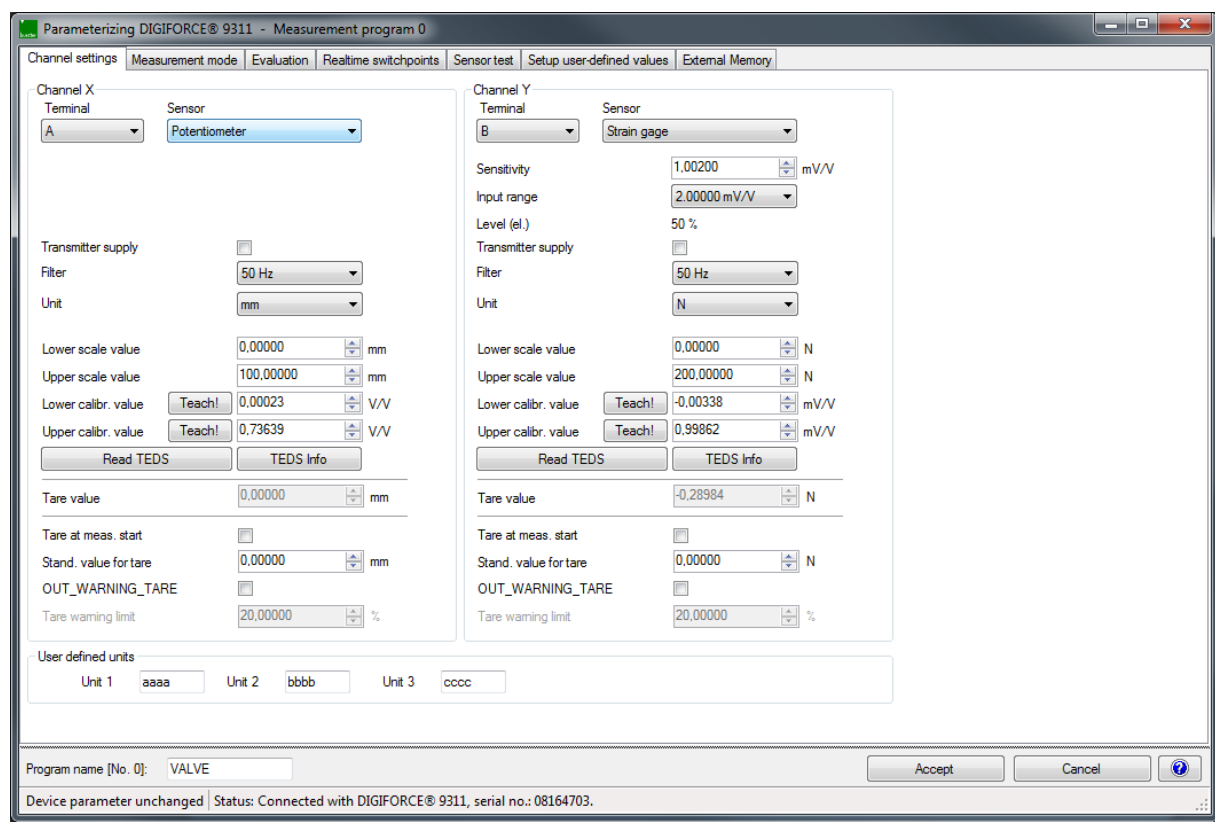

Diagram 31: DigiControl – Channel settings

Parameters in "Channel settings"

Terminal	A, B, t (time)	Assigning a physical connector to the measurement channel X or Y. (You can also define a time axis here.)
Sensor	Potentiometer, Standard signal, Strain gage, Piezo (optional)	Assigning the relevant sensor type: Connector A: Potentiometer or standard signal Connector B: Strain gage or standard signal (Piezo optional)

6.3.2.2 Scaling analog sensors (strain gage, potentiometer, standard signal sensors)

2-point scaling is used to associate the measured electrical signals with the measured physical quantities. In this process, you assign a lower and upper calibration value (electrical quantity) to a lower and upper scale value for the measured physical quantity. You can enter the "lower calibration" and "upper calibration" values (electrical quantities) as numerical values or you can measure them using the functions **[Teach!]**.

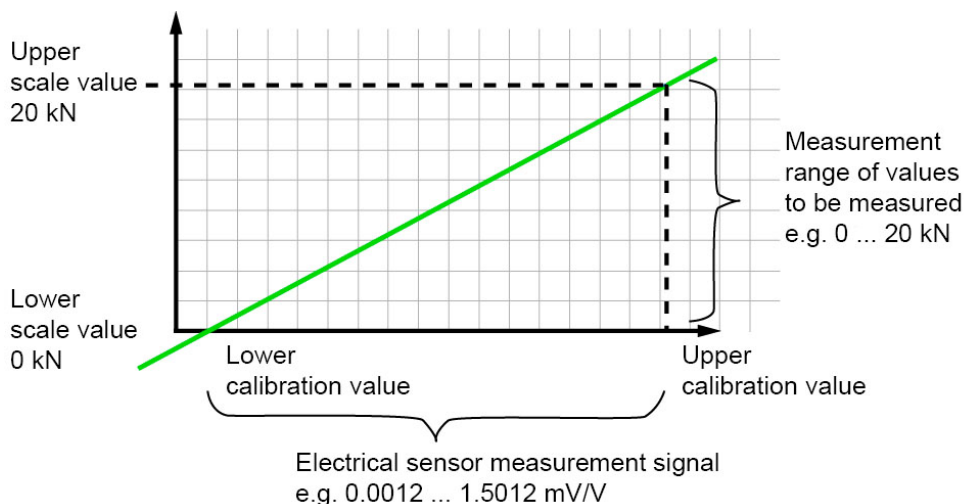

Diagram 32: Scaling analog sensors

6.3.2.3 Inverting measurement signals

You can easily invert a measurement signal using the sign definition for the scaling values given under "Lower scale value" and "Upper scale value".

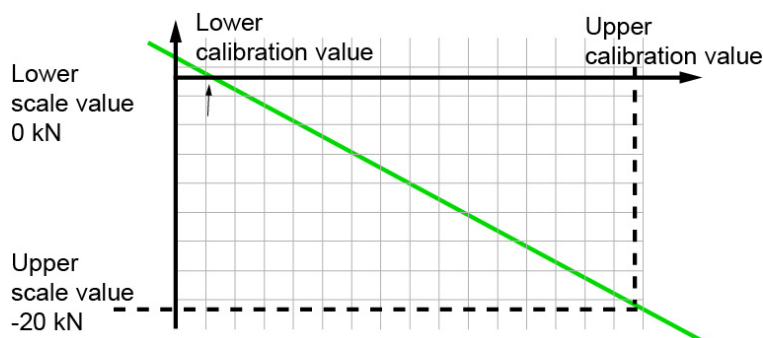

Diagram 33: Inverting measurement signals

6.3.2.4 Configuring sensors fitted with burster TEDS

If a connected sensor is equipped with burster TEDS, you can use the **[Read TEDS]** function in the Channel settings to get the DIGIFORCE® 9311 to upload the sensor specification. The DIGIFORCE® 9311 can then use this specification to make the necessary channel settings automatically. Further information on this feature appears below in the subsections dealing with the particular sensors. The DIGIFORCE® 9311 does not support the TEDS function for the optional piezoelectric input.

Note: If when using burster TEDS sensors you wish to invert a signal, you can do this by changing the sign in the scaling values. You must make the change after importing the TEDS data ("Read TEDS").

6.3.2.5 Potentiometric sensors

You can connect potentiometric sensors to connector A.

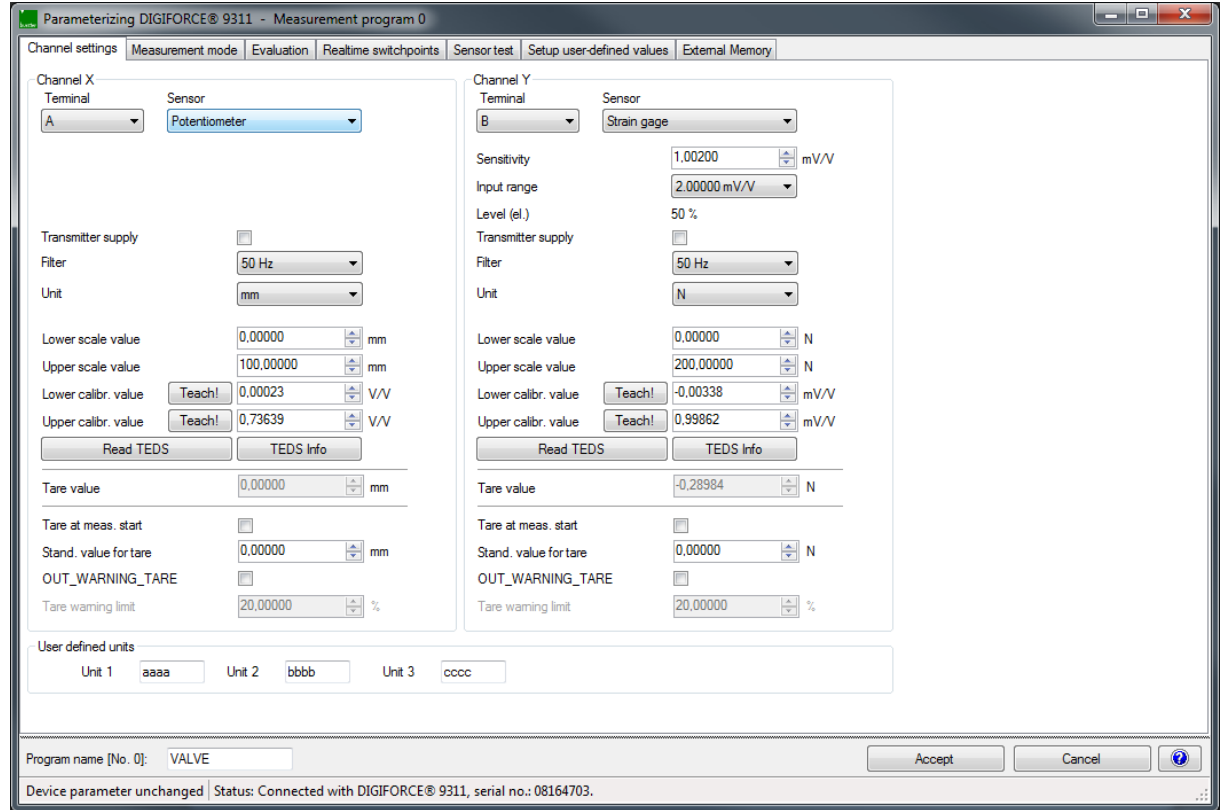

Diagram 34: Channel settings – Potentiometric sensors

Parameters in "Channel settings – Connector A - Potentiometer"

Transmitter supply	On / Off	Enable / Disable DC supply to sensor Note: The transmitter supply for connectors A and B is a common supply, i.e. it can only be enabled or disabled for both connectors together. Whatever is set for Transmitter supply (enabled or disabled), this always applies to both connectors.
Filter	Off, 5, 10, 25, 50, 100, 200, 400, 800 Hz	Filter setting for the measurement channel (Default value = 50 Hz)
Unit	mm, N, kN, Nm, Ncm, deg, bar, V, s, ms, aaaa, bbbb, cccc	Units for the measurement channel You can select the units from a list. Alternatively, you can also specify user-defined units.
Lower scale value	<value input>	Enter the lower scale value for 2-point scaling (typically = 0).
Upper scale value	<value input>	Enter the upper scale value for 2-point scaling (typically 100 % of the sensor measurement range).
Lower calibration value	<value input> <measurement>	Enter the lower calibration value for 2-point scaling or teach the value using the teach-in function. The [Teach!] button runs this function. The teach-in function only works if the sensor is connected and the correct channel parameters have been set. Units [V/V] The calibration values are normalized to an excitation voltage of 1 V. This eliminates errors caused by variations in excitation voltages, for instance if the DIGIFORCE® 9311 is replaced. In addition, sensors with a specific sensitivity can be configured without a teaching process.
Upper calibration value	<value input> <measurement>	Enter the upper calibration value for 2-point scaling or teach the value using the teach-in function. The [Teach!] button runs this function. The teach-in function only works if the sensor is connected and the correct channel parameters have been set. Units [V/V]
Read TEDS	Button	If a connected sensor is programmed with TEDS, you can use the [Read TEDS] function to get the DIGIFORCE® 9311 to upload the sensor specification. The DIGIFORCE® 9311 can then use this specification to make the necessary channel settings automatically.
TEDS Info	Button	Displays the data from the potentiometric sensor programmed with TEDS.
Tare at meas. start	On / Off	Enable / Disable

		Enabled: At the start of a measurement, the channel is automatically tared to the default tare value ("Standard value for tare").
Stand. value for tare	<value input>	A typical tare value is 0.0.
OUT_WARNING_TARE	On / Off	Enable / Disable Enabled: If the signal to be tared exceeds the "Tare warning limit", the "OUT_WARNING_TARE" control output is set. Note: This may also indicate that the sensor is faulty.
Tare warning limit	--- / 1 to 20 %	The "Tare warning limit" can be set between 1 % and 20 % with respect to the actual measurement range of the input channel (regardless of the current scaling). Note: Please note when using sensors with a high zero point offset, the function "Tare warning limit" can only be used in a limited extent or not at all.
User defined units	<value input>	The "User defined units" parameter offers you a choice of physical units. If you want to use different units, however, you can define your own.

Note: The mechanical travel of potentiometric displacement sensors is greater than the specified measurement travel. Therefore an electrical dead zone usually exists at each end. Within this zone, you cannot measure any change in the electrical output signal despite a movement being made.

The **[Teach!]** button can be used to measure the upper and lower calibration values. For the calibration, use a calibrated gage block that matches the full measurement range of the sensor as closely as possible.

Make sure that both measurement points lie outside the specified dead zone. There must be a certain distance between the measurement points and the mechanical limits of travel of the sensor. We recommend positioning the measurement range with respect to the mechanical center ($\pm 50\%$ about the mechanical center).

6.3.2.5.1 Sensors that output a standard signal

You can connect standard-signal sensors to connectors A and B.

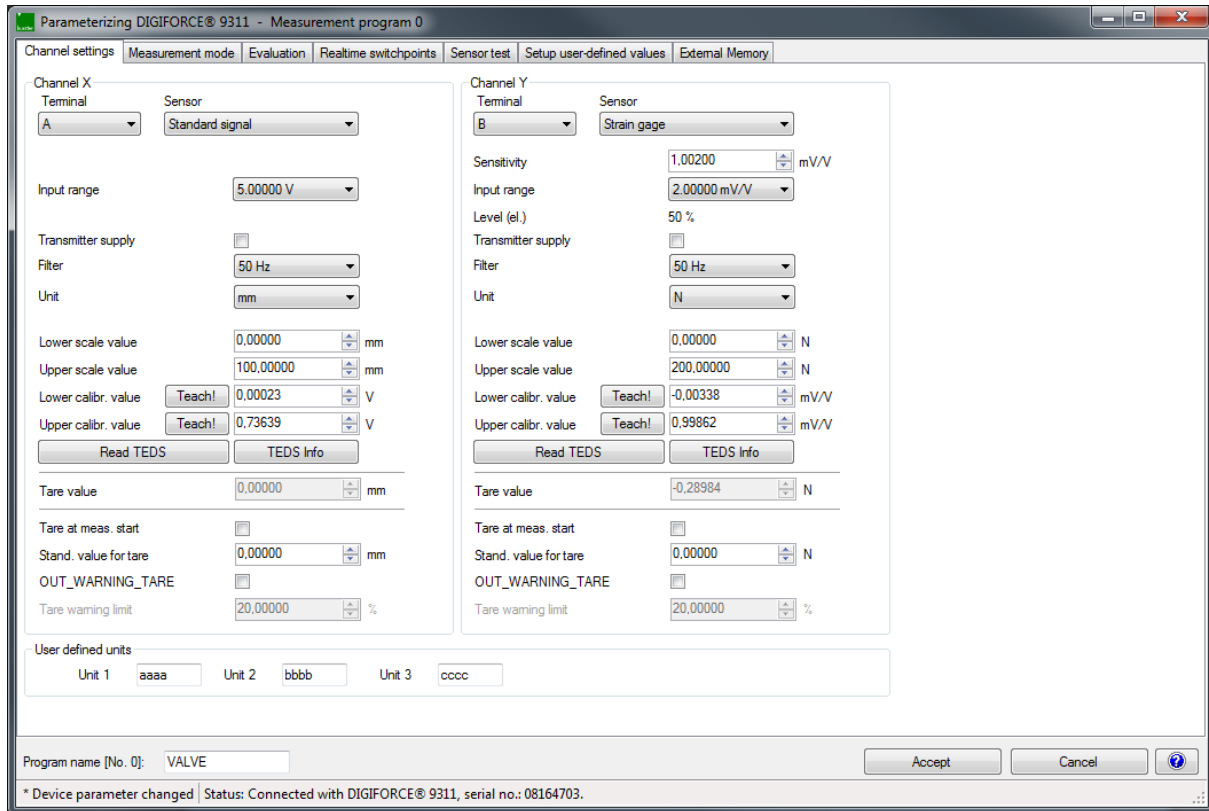

Diagram 35: Channel settings – Standard signal

Parameters in "Channel settings – Connector A/B – Standard signal"

Input range	5.00000, 10.0000 V	Input range selection: 5 V or 10 V
Transmitter supply	On / Off	Enable / Disable DC supply to sensor Note: The transmitter supply for connectors A and B is a common supply, i.e. it can only be enabled or disabled for both connectors together. Whatever is set for Transmitter supply (enabled or disabled), this always applies to both connectors.
Filter	Off, 5, 10, 25, 50, 100, 200, 400, 800 Hz	Filter setting for the measurement channel (Default value = 50 Hz)
Unit	aaaa, bbbb, cccc, mm, N, kN, Nm, Ncm, deg, bar, V, s, ms	Units for the measurement channel You can select the units from a list. Alternatively, you can also specify user defined units.
Lower scale value	<value input>	Enter the lower scale value for 2-point scaling (typically = 0).
Upper scale value	<value input>	Enter the upper scale value for 2-point scaling (typically 100 % of the sensor measurement range).
Lower calibration	<value input>	Enter the lower calibration value for 2-point scaling or

	<measurement>	<p>teach the value using the teach-in function.</p> <p>The [Teach!] button runs this function.</p> <p>The teach-in function only works if the sensor is connected and the correct channel parameters have been set.</p> <p>Units [V]</p>
Upper calibration	<value input> <measurement>	<p>Enter the upper calibration value for 2-point scaling or teach the value using the teach-in function.</p> <p>The [Teach!] button runs this function.</p> <p>The teach-in function only works if the sensor is connected and the correct channel parameters have been set.</p> <p>Units [V]</p>
Read TEDS	Button	<p>If a connected sensor is programmed with TEDS, you can use the [Read TEDS] function to get the DIGIFORCE[®] 9311 to upload the sensor specification. The DIGIFORCE[®] 9311 can then use this specification to make the necessary channel settings automatically.</p>
TEDS Info	Button	<p>Displays the data from the potentiometric sensor programmed with TEDS.</p>
Tare at meas. start	On / Off	<p>Enable / Disable</p> <p>Enabled:</p> <p>At the start of a measurement, the channel is automatically tared to the default tare value ("Standard value for tare").</p>
Stand. value for tare	<value input>	<p>A typical tare value is 0.0.</p>
OUT_WARNING_TARE	On / Off	<p>Enable / Disable</p> <p>Enabled:</p> <p>If the signal to be tared exceeds the "Tare warning limit", the "OUT_WARNING_TARE" control output is set.</p> <p>Note: This may also indicate that the sensor is faulty.</p>
Tare warning limit	--- / 1 to 20 %	<p>The "Tare warning limit" can be set between 1 % and 20 % with respect to the actual measurement range of the input channel (regardless of the current scaling).</p> <p>Note: Please note when using sensors with a high zero point offset, the function "Tare warning limit" can only be used in a limited extent or not at all.</p>
User defined units	<value input>	<p>The "User defined units" parameter offers you a choice of physical units. If you want to use different units, however, you can define your own.</p>

6.3.2.5.2 Strain gage sensors

You can connect strain gage sensors to connector B.

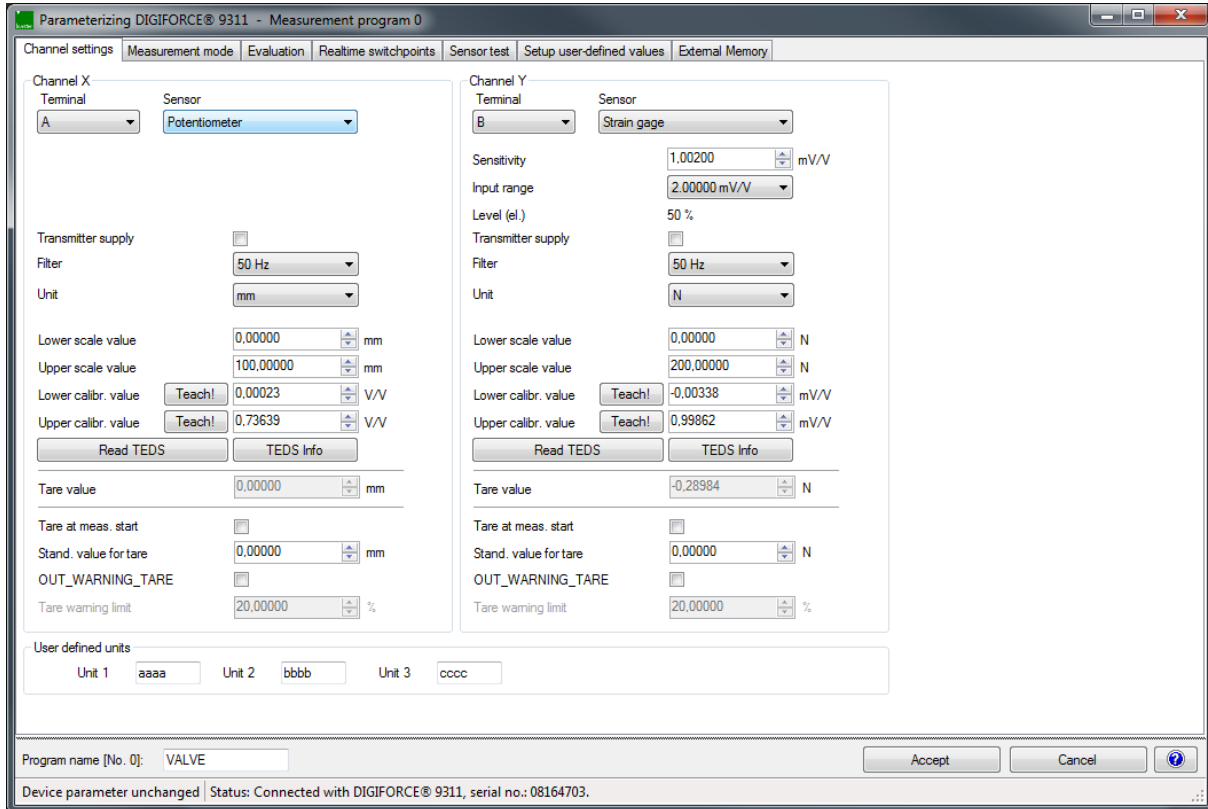

Diagram 36: Channel settings – Strain gage

Parameters in "Channel settings – Connector B – Strain gage"

Sensitivity	<value input> 0.02 ... 100 mV/V	Enter the strain gage sensitivity This value is used solely for calculating and displaying the electrical output level. This parameter has no relevance to the internal channel settings.
Input range	2.00000, 4.00000, 10.0000, 20.0000, 40.0000 mV/V	Input range selection for the strain gage In order to be able to use 100 % of the measurement range of the connected sensor, the selected input range must be ≥ the sensor sensitivity.
Level (el.)	Value in %	Shows the electrical output level from the measurement channel $\frac{\text{Sensitivity} * 100 \%}{\text{Input range}}$
Transmitter supply	On / Off	Enable / Disable DC supply to sensor Note: The transmitter supply for connectors A and B is a common supply, i.e. it can only be enabled or disabled for both connectors together. Whatever is set for Transmitter supply (enabled or disabled), this always applies to both connectors.

DIGIFORCE® model 9311

Filter	Off, 5, 10, 25, 50, 100, 200, 400, 800 Hz	Filter setting for the measurement channel (Default value = 50 Hz)
Unit	mm, N, kN, Nm, Ncm, deg, bar, V, s, ms, aaaa, bbbb, cccc	Units for the measurement channel You can select the units from a list. Alternatively, you can also specify user-defined units.
Lower scale value	<value input>	Enter the lower scale value for 2-point scaling (typically = 0).
Upper scale value	<value input>	Enter the upper scale value for 2-point scaling (typically 100 % of the sensor measurement range).
Lower calibration value	<value input> <Teach!>	Enter the lower calibration value for 2 point scaling or teach the value using the teach-in function. The [Teach!] button runs this function. The teach-in function only works if the sensor is connected and the correct channel parameters have been set. Unit [mV/V] The calibration values are normalized to 1 V excitation voltage. This eliminates errors caused by variations in excitation voltages, for instance if the DIGIFORCE® 9311 is replaced. In addition, sensors with a specific sensitivity can be configured without a teach-in process.
Upper calibration value	<value input> <Teach!>	Enter the upper calibration value for 2 point scaling or teach the value using the teach-in function. The [Teach!] button runs this function. The teach-in function only works if the sensor is connected and the correct channel parameters have been set. Unit [mV/V]
Read TEDS	Button	If a connected sensor is programmed with TEDS, you can use the [Read TEDS] function to get the DIGIFORCE® 9311 to upload the sensor specification. The DIGIFORCE® 9311 can then use this specification to make the necessary channel settings automatically.
TEDS Info	Button	Displays the data from the sensor programmed with TEDS.
Tare at meas. start	On / Off	Enable / Disable Enabled: At the start of a measurement, the channel is automatically tared to the default tare value ("Standard value for tare").
Standard value for tare	<value input>	A typical tare value is 0.0.
OUT_WARNING_TARE	On / Off	Enable / Disable

		<p>Enabled:</p> <p>If the signal to be tared exceeds the "Tare warning limit", the "OUT_WARNING_TARE" control output is set.</p> <p>Note: This may also indicate that the sensor is faulty.</p>
Tare warning limit	--- / 1 to 20 %	<p>The "Tare warning limit" can be set between 1 % and 20 % with respect to the actual measurement range of the input channel (regardless of the current scaling).</p> <p>Note: Please note when using semiconductor strain gage sensors with a high zero point offset, the function "Tare warning limit" can only be used in a limited extent or not at all.</p>
User defined units	<value input>	<p>The "User defined units" parameter offers you a choice of physical units. If you want to use different units, however, you can define your own.</p>

DIGIFORCE® model 9311

6.3.2.5.3 Piezoelectric sensors (option)

You can connect piezoelectric sensors (with a charge output) only to the optional piezoelectric input (connector B).

Note: For this function your DIGIFORCE® 9311 must be fitted with the optional piezoelectric input. With this option, connector B for a strain-gage or standard-signal input is no longer provided. The DIGIFORCE® 9311 does not support the TEDS function for the optional piezoelectric input.

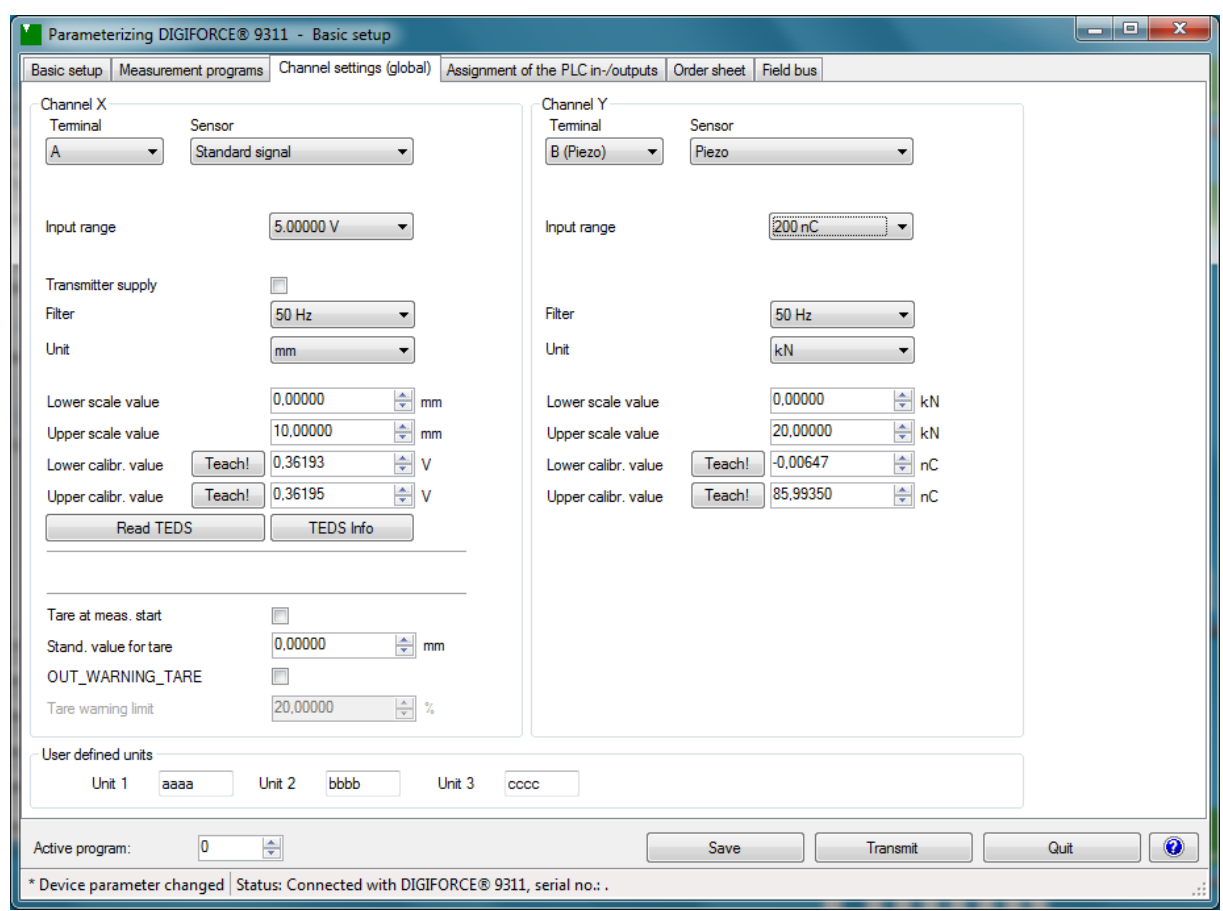

Diagram 37: Channel settings Piezo

Parameters in "Channel settings – Connector B - Piezo"

Input range	1, 2, 5, 10, 20, 40, 80, 200, 400 nC, 1 µC	Input range selection for the piezoelectric sensor You can calculate the required input range by multiplying the sensor sensitivity (e.g. 4.3 pC/N) by the measurement range. Then choose the appropriate input range; if the exact level is not available, select the next higher level.
Filter	Off, 5, 10, 25, 50, 100, 200, 400, 800 Hz	Filter setting for the measurement channel (Default value = 50 Hz)
Unit	mm, N, kN, Nm, Ncm, deg, bar, V, s, ms, aaaa, bbbb, cccc	Units for the measurement channel You can select the units from a list. Alternatively, you can also specify user-defined units.

Lower scale value	<value input>	Enter the lower scale value for 2-point scaling (typically = 0).
Upper scale value	<value input>	Enter the upper scale value for 2-point scaling (typically this is 100% of the sensor measurement range, or can be set as a multiple of 1, because the sensitivity of piezoelectric sensors is always specified as charge/mechanical units e.g. pC/N).
Lower calibration value	<Teach!>	Measurement of the lower calibration value for 2-point scaling. The [Teach!] button runs this function. The teach-in function only works if the sensor is connected and the correct channel parameters have been set. It is not possible to input a numerical value for piezoelectric sensors.
Upper calibration value	<value input> <Teach!>	Enter the upper calibration value for 2 point scaling or teach the value using the teach-in function. The [Teach!] button runs this function. The teach-in function only works if the sensor is connected and the correct channel parameters have been set.

Note: Please note that if you are basing the upper calibration value on the specified sensor sensitivity (value from the sensor test certificate) then you need to add on the trained lower calibration value when you enter the value. The difference between the upper and lower calibration values must equal the sensitivity of the sensor or the selected multiple of the current scaling.

DIGIFORCE® model 9311

Teach-in the piezoelectric rated output

As an alternative to entering a sensor rated output from the manufacturer's sensitivity figure (e.g. from the sensor test certificate), you can use **[Teach!]** to teach the electrical calibration values while measuring against a reference or known load values.



This is how it works

- 1 Click on "File" > "Parameterize from device".

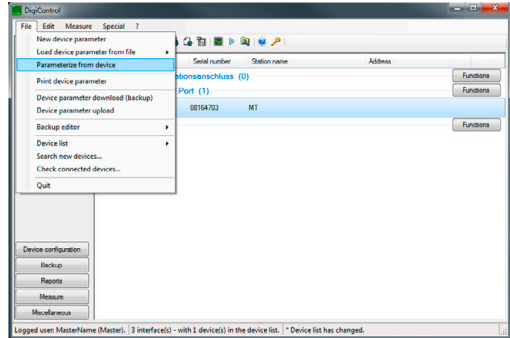

- 2 You are now in the menu "Parameterizing DIGIFORCE® 9311 - Basic setup". Click on the "Channel settings (global)" tab and select connector "B (Piezo)" for the relevant channel (Channel Y).

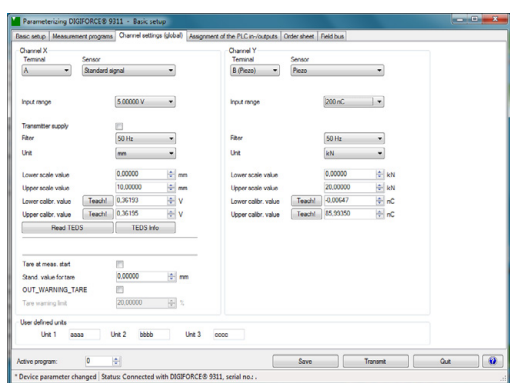

- 3 Select the correct charging range (Input range).

Note: You can calculate the correct charging range (Input range) from the sensor sensitivity per unit (e.g. nC/N) multiplied by the measurement range required. Example: Piezoelectric sensor with sensitivity 4.3 pC/N @ 20 kN = 86 nC. Then select the corresponding or next higher measurement range; in this example 200 nC.

- 4 Enter the "Lower scale value" (usually = 0 N).

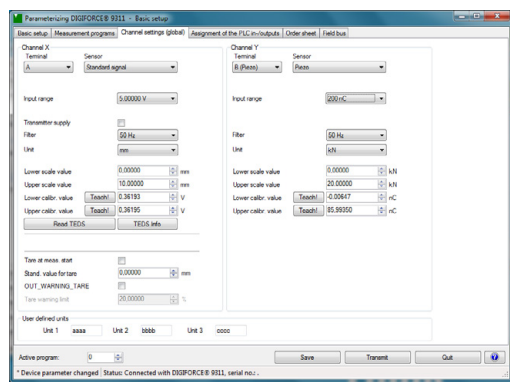

- 5 Click **[Teach!]** beside "Lower calibr value".
The "Teach in calibration value..." window opens. Click **[OK]**.

IMPORTANT: Make sure that the loads do not change during the teach-in training process. The system must be under zero load or in the rest state throughout the process.

- 6 Click **[Teach!]** beside "Upper calibr value".
IMPORTANT: Only now is the piezo-channel active, allowing a change in charge level to be measured. Now make a change to the load and wait until you can read a stable value from the reference display.
The "Teach in calibration value..." window opens. Click **[OK]**.

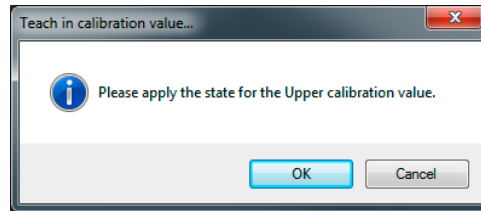
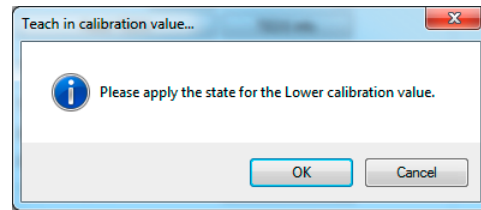

- 7 Then enter the reading from the reference measurement for "Upper scale value".
- 8 Click on "Transmit".

6.3.2.6 Measurement mode

Under "Measurement mode" you can specify the signal acquisition parameters for the measurement phase. Essentially the parameters you need to set are the signal sampling, the X-reference for the measurement curve, the curve segment (just to Return point or the Complete curve) and the start/stop condition for the measurement phase.

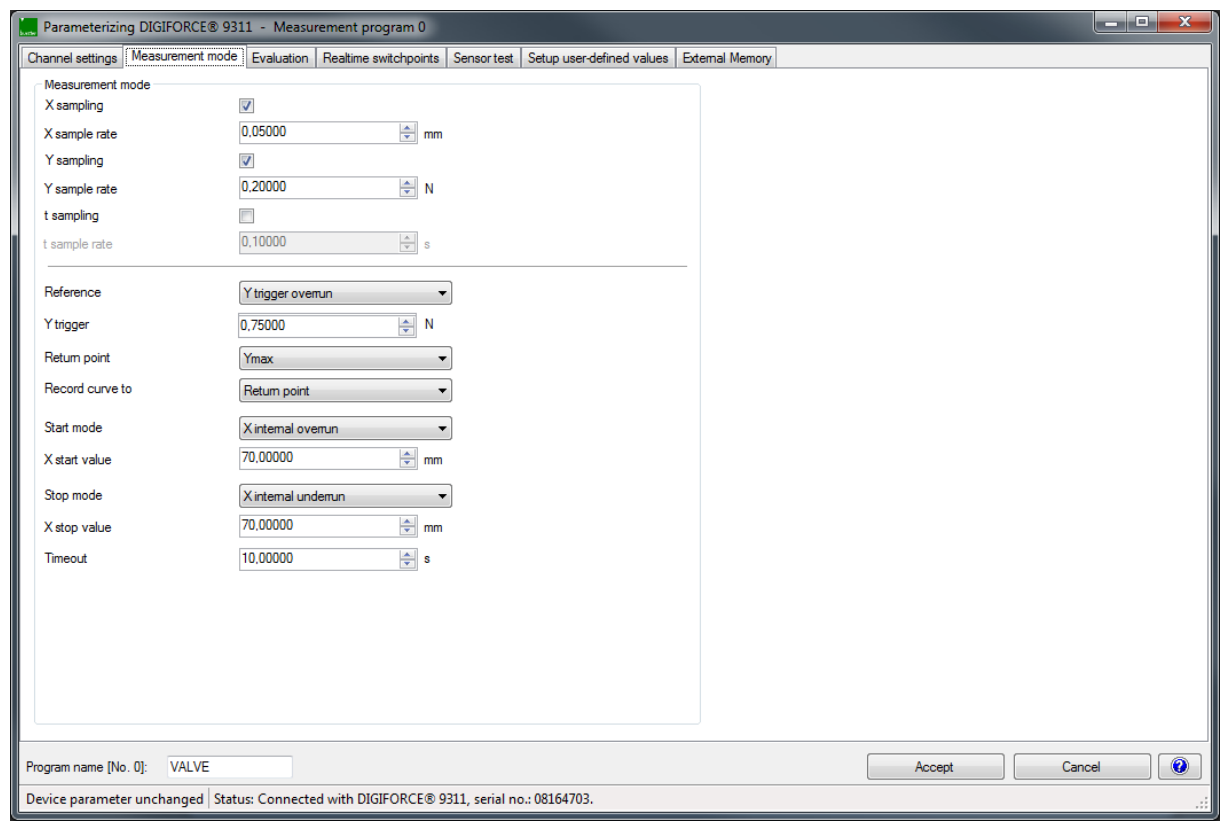

Diagram 38: DigiControl – Measurement mode

Note: The "Timeout" function for stopping a measurement is always enabled, so choose a value of suitable period. If an internal Stop condition for terminating the measurement is not reached, for instance, the Timeout will still stop the measurement.

6.3.2.6.1 Sampling the measurement channels

The DIGIFORCE® 9311 lets you sample signals using a combination of time interval (Δt), X-interval and Y-interval (ΔX , ΔY). This provides flexibility while also letting you compress the measurement recording. It means that you can use just a few measurement points to record curve regions containing a constant or steadily changing signal, whereas you can use more points when you need to record and reproduce steep signal slopes or alternating waveforms.

Note: When setting the signal sampling, don't forget that there is a maximum memory capacity for the measurement curve data. The DIGIFORCE® 9311 can store a maximum of 5000 value pairs per measurement. Thus with the fastest possible sampling time of 0.1 ms per sample, the curve memory is full after 0.5 s.

X sampling	On / Off	Enable / Disable
X sample rate	<value input>	Enter the sample interval for the X-channel For values that are less than the channel resolution, the smallest available sample interval is used automatically. Range 0.00001 to 999999
Y sampling	On / Off	Enable / Disable
Y sample rate	<value input>	Enter the sample interval for the Y-channel For values that are less than the channel resolution, the smallest available sample interval is used automatically. Range 0.00001 to 999999
t sampling	On / Off	Enable / Disable time-based sampling
t sample rate	<value input>	Enter the sampling time interval here Range 0.0001 to 99999.0 seconds

6.3.2.6.2 Measurement curve reference

The DIGIFORCE® 9311 provides the following X-references for the measurement curve:

Reference	Absolute	The DIGIFORCE® 9311 references the measurement curve to the absolute zero point of the measurement system on the X-channel (e.g. displacement sensor).
	Final force	The last measurement point of the forward measurement curve is the reference point (X = 0). For a forward and return curve, the return point is the reference.
	Y reference line overrun, Y reference line underrun <value input>	The reference point is where the curve crosses above or below the set Y-level (Y reference line). Enter the value for the Y-level.
	Y trigger overrun, Y trigger underrun <value input>	The reference point is where the curve crosses above or below the set Y-level (Y trigger). Note: For the "Crossing trigger threshold" reference, the DIGIFORCE® 9311 does not start saving curve data until the trigger event has occurred. The measurement, however, must be started before the trigger event. Enter the value.

Absolute reference

By selecting the "Absolute" setting you are setting the X-axis reference of the measurement curve to the zero point of the currently connected sensor.

You can choose the "Absolute" reference option when you are able to position both parts involved in a joining process with repeat precision, i.e. the workpiece support always positions the workpiece at the same height, and the two parts to be joined (A+B) themselves have negligible tolerances in the insertion direction. In addition, part A must always start in the same position with respect to part B.

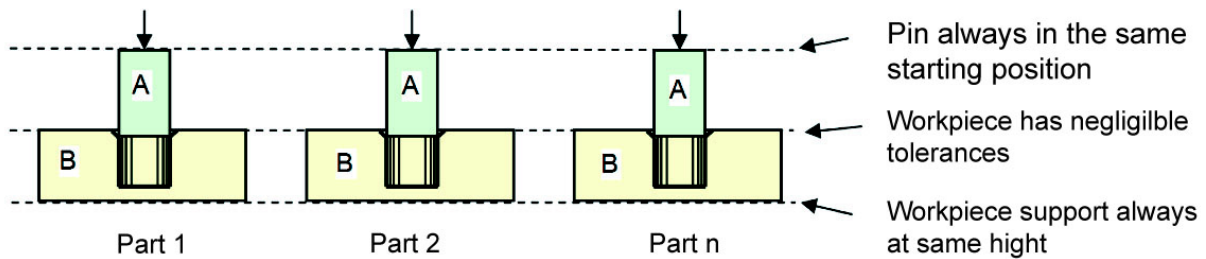

Diagram 39: "Absolute" reference with parts A and B to be joined

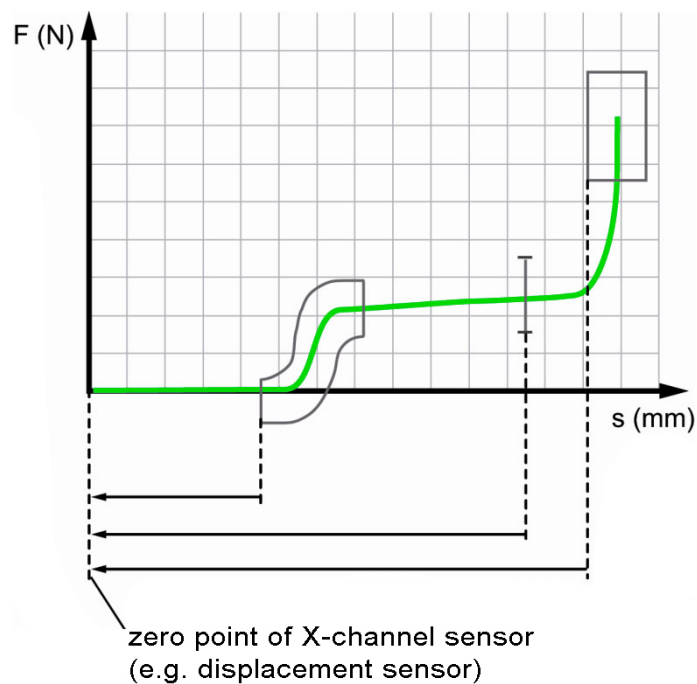

Diagram 40: Example of a measurement curve using the "Absolute" reference

DIGIFORCE® model 9311

Final force reference

With the "Final force" reference (final force used as the reference), the DIGIFORCE® 9311 shifts the curve to after the measurement phase and references it to the X-value of the last measurement point (final force). If a measurement curve contains a forward and return section, the DIGIFORCE® 9311 sets the return point as zero when the reference is set to "Final force".

In joining processes, the end position is known accurately and validated in advance, for instance the depth of the hole in a bearing seat. The press reaches its maximum force at this point. The DIGIFORCE® 9311 then uses this position as the reference value (zero) in the evaluation.

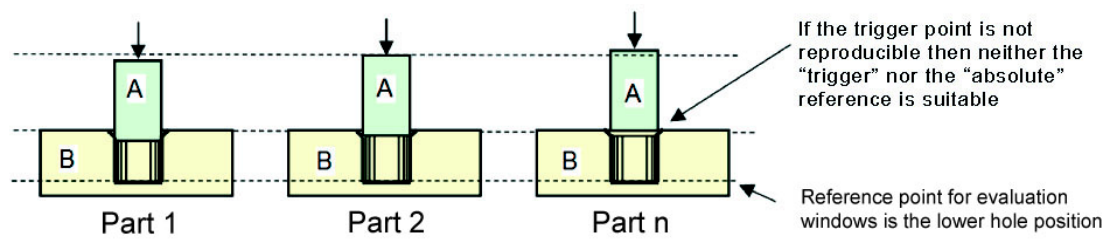

Diagram 41: "Final force" reference with parts A and B to be joined

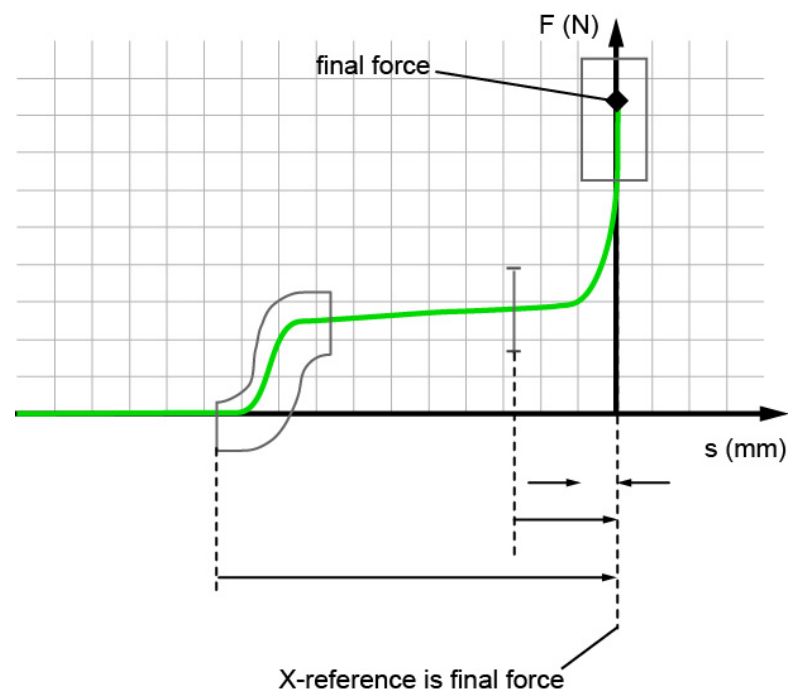

Diagram 42: Example of a measurement curve using the "Final force" reference

Note: In pneumatic or hydraulic presses, for instance, variations in the final force and the associated bending of the mounting system (press frame) may also cause variations in the X-position.

Note: Online evaluation of the "Window" graphical evaluation element is only relevant for the "Absolute" and "Crossing trigger threshold" references. When the "Final force" or "Crossing reference line" reference is used, the measurement curve is recalculated and repositioned after the measurement. In these cases, the online evaluation uses the absolute X-reference for its live response.

Reference: crossing Y reference line

With the "Reference line" reference, the DIGIFORCE® 9311 shifts the curve to after the measurement phase. In this case, the DIGIFORCE® 9311 references the curve to the point at which it crosses a configurable Y reference level.

If the final force in a pneumatic or hydraulic press varies, then using the "Final force" reference would produce a spread in otherwise identical measurement curves. You can eliminate this variation, however, by selecting a reference line that is below the final force of the press.

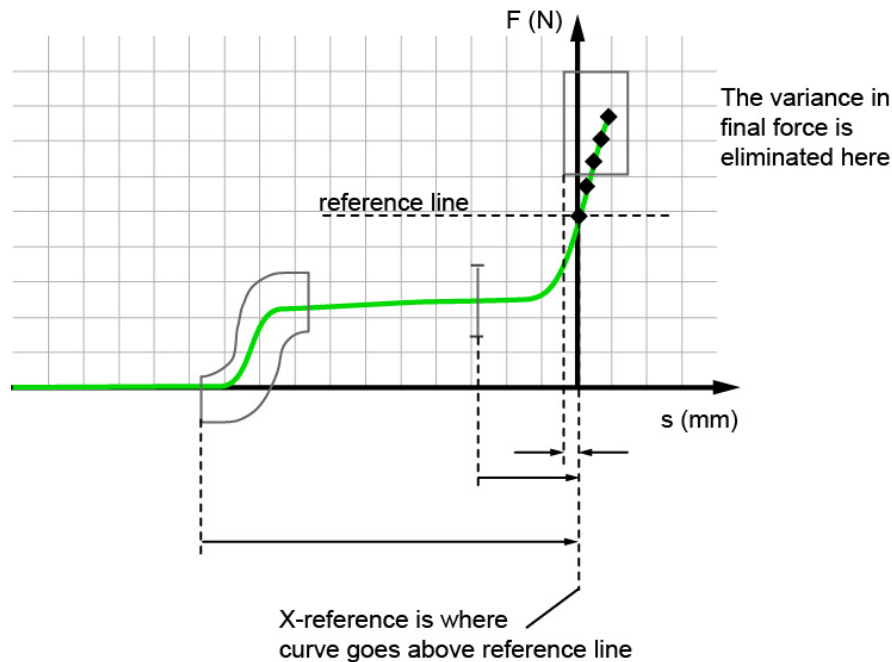

Diagram 43: Example of a measurement curve using the "Reference line" reference

Note: Online evaluation of the "Window" graphical evaluation element is only relevant for the "Absolute" and "Crossing trigger threshold" references. When the "Final force" or "Crossing reference line" reference is used, the measurement curve is recalculated and repositioned after the measurement. In these cases, the online evaluation uses the absolute X-reference for its live response.

DIGIFORCE® model 9311

Reference: crossing Y trigger threshold

Unlike the "Absolute", "Final force" and "Reference line" references, when the "Trigger" reference is used, recording of the measurement does not start until the measurement crosses the configured threshold (e.g. force threshold). The DIGIFORCE® 9311 writes the value pairs of the measurement curve from this point onwards into the curve memory. Thus the DIGIFORCE® 9311 does not record any curve data in the time period between the start of the measurement phase and the trigger event. The point at which the trigger threshold is crossed acts as the reference point ($X = 0$) in this case.

The "Trigger" reference helps to eliminate permitted component tolerances from the X/Y curve. For instance when press-fitting a straight pin into a coupling, the force/displacement recording is started when the press head makes contact with the component. The DIGIFORCE® 9311 simultaneously references the force/displacement recording to the configurable contact force.

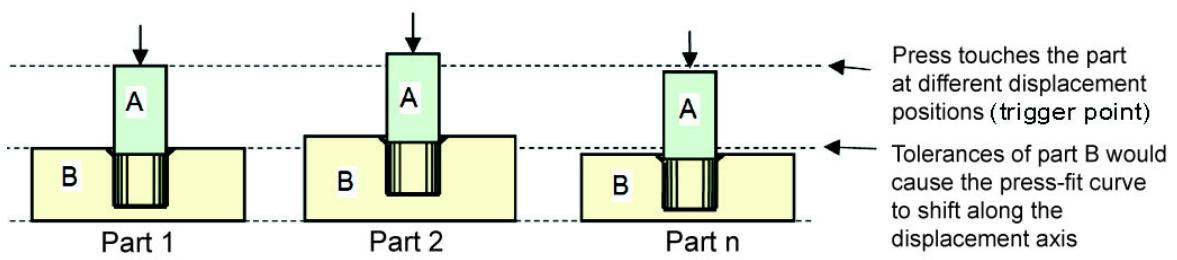

Diagram 44: "Trigger" reference with parts A and B to be joined

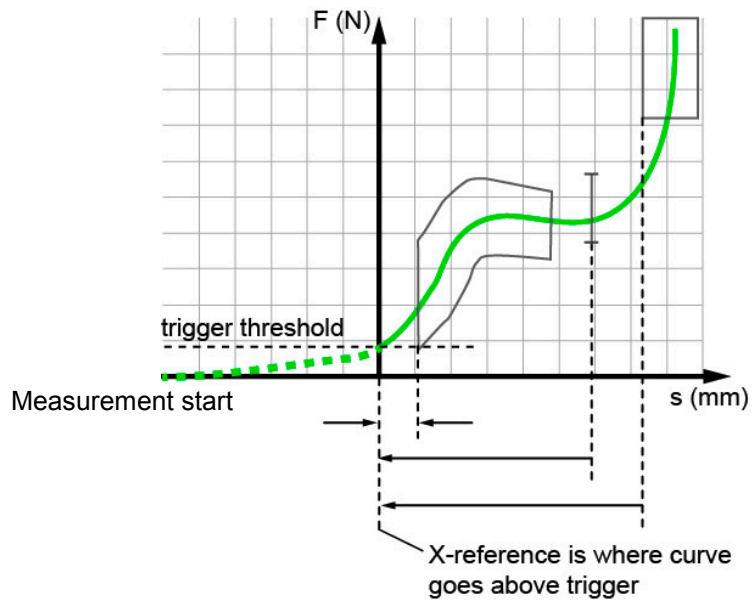

Diagram 45: Example of a measurement curve using the "Trigger" reference

Note: The measurement must start before the trigger event happens!

6.3.2.6.3 Curve recording, return point

The DIGIFORCE® 9311 divides a recorded measurement curve into two curve segments: a forward segment and a return segment.

You can use the "Record curve to" parameter to select between "Complete curve" and "Return point". Select "Complete curve" to display and evaluate the forward and return segments of the measurement curve. "Return point" means that the DIGIFORCE® 9311 displays and evaluates only the forward segment up to the defined return point.

You use the "Return point" parameter to specify which point in the curve is the last value pair of the forward curve, i.e. is the return point. You can choose from "Xmin", "Xmax", "Ymin" and "Ymax". When opting to record the "Complete curve", this return point is marked as a green diamond.

Return point	Xmin, Xmax, Ymin, Ymax	The DIGIFORCE® 9311 uses the specified value to determine the last measurement point of the forward curve, i.e. the return point.
Record curve to	Return point / Complete curve	<p>Return point: The DIGIFORCE® 9311 displays and evaluates just the forward curve.</p> <p>Complete curve: The DIGIFORCE® 9311 displays and evaluates the entire curve (forward and return segments).</p>

Example 1

Setting the return point; recording up to the return point

Record curve to: Return point

Return point: Ymax

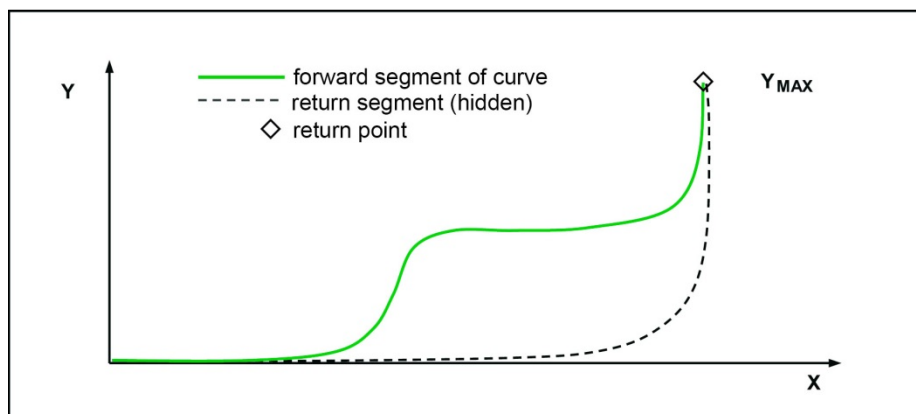

Diagram 46: Example 1: record the curve up to the return point Ymax

Example 2

Record curve to: Return point

Return point: Xmax

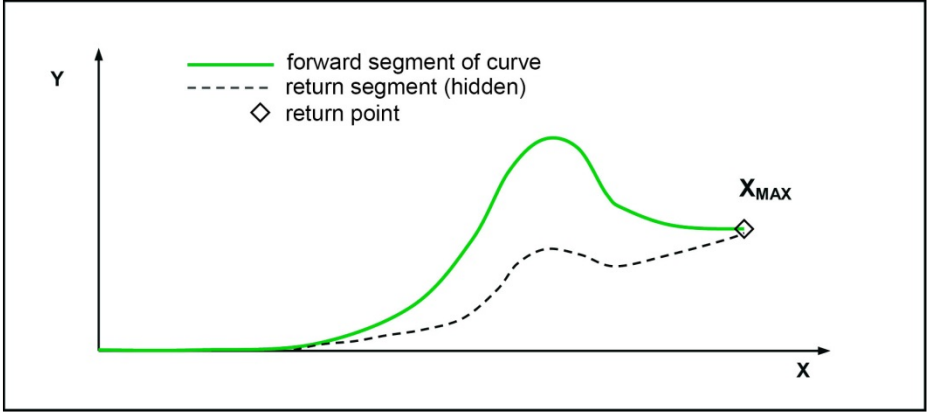

Diagram 47: Example 2: record the curve up to the return point Xmax

6.3.2.6.4 Start/Stop mode

The DIGIFORCE® 9311 lets you set separate start/stop conditions for recording a measurement curve. Apart from the routine practice of using an external control signal, you can also start or stop a measurement when a sensor signal crosses a defined threshold.

Start mode	External, X internal overrun, X internal underrun, Y internal overrun*, Y internal underrun* *not with Piezo option	External (PLC I/O or Fieldbus): The measurement starts on the rising edge of the "IN_START" control signal X internal over-/underrun: You also need to define the X-channel start threshold (X start value) Y internal over-/underrun: You also need to define the Y-channel start threshold (Y start value)
X / Y start value	---- / <value input>	Set here the start-condition threshold if an internal start mode is selected. Use the keypad to enter the value.
Stop mode	External, X internal overrun, X internal underrun, Y internal overrun, Y internal underrun, Timeout, Number of readings	External (PLC I/O or Fieldbus): The measurement is stopped on the falling edge of the "IN_START" control signal X internal over-/underrun: You also need to define the X-channel stop threshold (X stop value) Y internal over-/underrun: You also need to define the Y channel stop threshold (Y stop value) Timeout: The measurement only is stopped after the specified time has elapsed Number of readings: The measurement is stopped once the specified number of measurement-value pairs has been recorded
X / Y stop value; Number of readings	---- / <value input>	Set here the stop-condition threshold if an internal stop mode is selected. Alternatively, if "No.of readings" is selected as the stop event, specify here the number of readings. Use the keypad to enter the value.
Timeout	<value input>	Range: 0.0001 < timeout ≤ 99999 seconds The timeout function for stopping the measurement is always active. You therefore need to enter a suitable time value.

IMPORTANT: The timeout function for stopping the measurement is always active, i.e. even in the "External" stop mode. You therefore always need to enter a suitable time value.

DIGIFORCE® model 9311

6.3.2.7 Configuring the evaluation

You can enable and configure graphical evaluation elements on the DIGIFORCE® 9311.

On the "Evaluation" tab you can select and enable the graphical evaluation elements and also set their numerical values.

The DIGIFORCE® 9311 provides the following graphical evaluation elements:

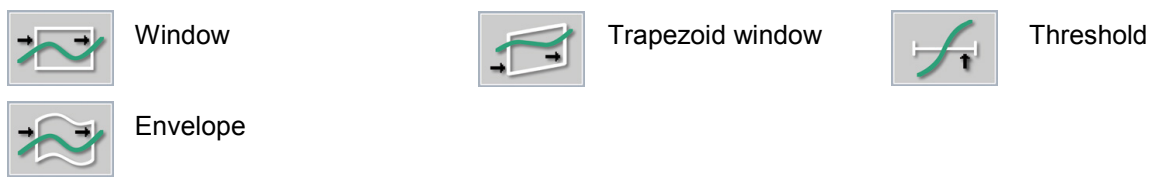

6.3.2.7.1 Window

One of the most commonly used graphical evaluation elements is the "Window". You can set up to three "Windows" in one measurement program. You define a "Window" (as a rectangle) by its corner points Xmin, Xmax, Ymin and Ymax. You are free to specify how the measurement curve enters and exits the "Window". For instance you can set the "Entry bottom" and "No exit" conditions to monitor the end-position situation in a press-fit process. You can assign an online signal ("OUT_NOK_ONL") to a "Window". The DIGIFORCE® 9311 actuates this online signal immediately the curve fails to pass correctly through the window. This lets you intervene directly and quickly in the process as soon as the DIGIFORCE® 9311 registers a deviation from the required path of the curve.

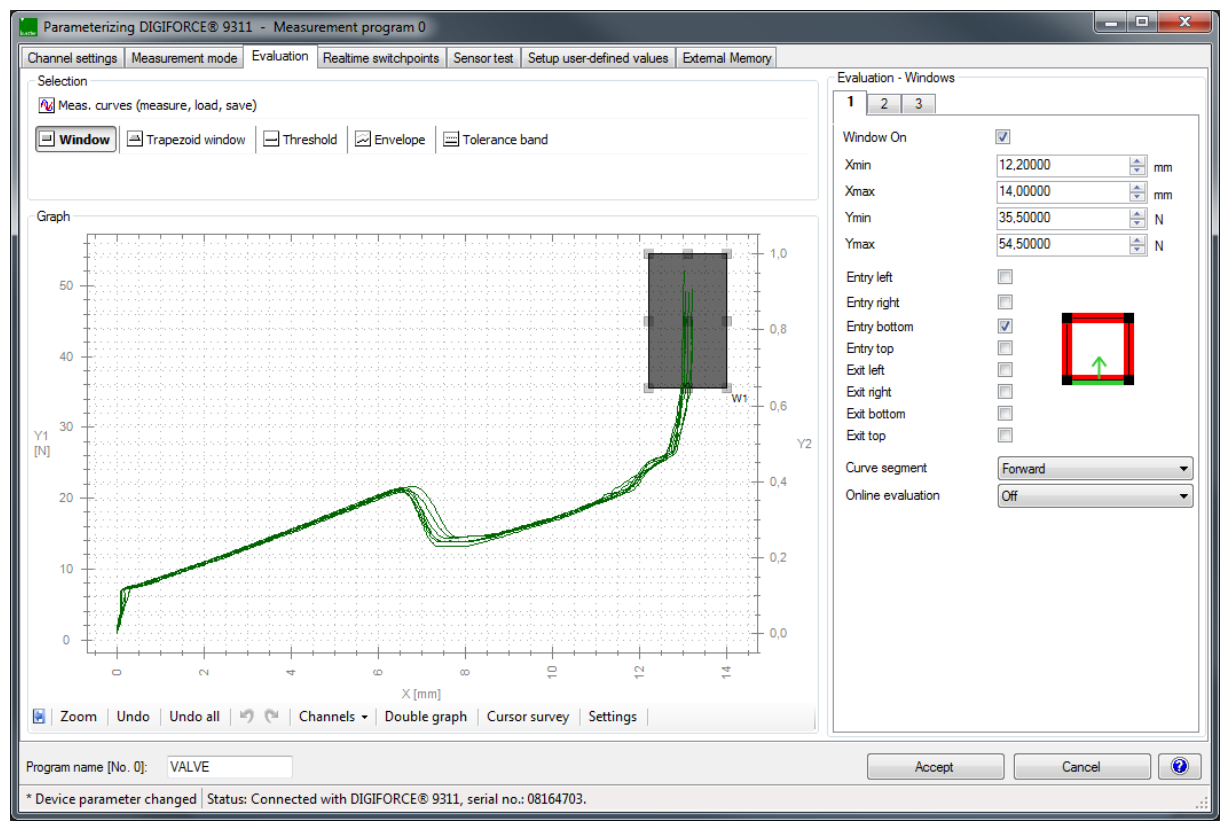
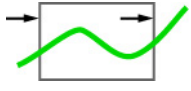
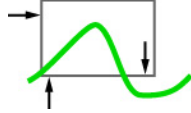
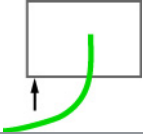
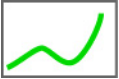
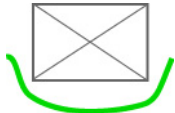

Diagram 48: Window evaluation element



The "Window" graphical evaluation element outputs an OK/NOK result at the end of the measurement phase. In addition, the DIGIFORCE® 9311 calculates the entry and exit coordinates and the absolute minimum and maximum in the window area.

Examples of windows

Symbol	Description
	Window with "Left" entry side and "Right" exit side (pass-through window).
	Window with two entry sides, "Left" or "Bottom", and one exit side, "Bottom" (pass-through window).
	Window with one entry side, "Bottom" (block window).
	Window without entry or exit; measurement curve lies entirely inside the window.
	Window without entry or exit; measurement curve lies entirely outside the window (NOT window).

The "Window" graphical evaluation element outputs the following results data:

Individual evaluation

 or 	The DIGIFORCE® 9311 can also output the evaluation result from a single window at the I/O port and/or the Fieldbus interface.
--	---

Entry

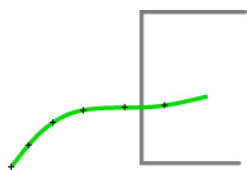
Symbol	Window evaluation element
	<p>The DIGIFORCE® 9311 linearly interpolates the window entry coordinates from the last measurement point outside the window and the first measurement point inside the window.</p> <p>If the measurement curve starts inside the window area, the DIGIFORCE® 9311 outputs the first measurement point (start value).</p> <p>If the entire measurement curve lies outside the window area, the DIGIFORCE® 9311 indicates/outputs the value pair 909090/909090 and displays "<<<>>>" on the screen.</p>

DIGIFORCE[®] model 9311

Exit

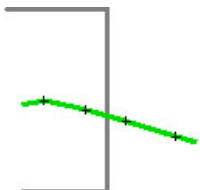
Symbol	Window evaluation element
	<p>The DIGIFORCE[®] 9311 linearly interpolates the window exit coordinates from the last measurement point inside the window and the first measurement point outside the window.</p> <p>If the measurement curve ends inside the window area, the DIGIFORCE[®] 9311 outputs the last measurement point.</p> <p>If the entire measurement curve lies outside the window area, the DIGIFORCE[®] 9311 indicates/outputs the value pair 909090/909090 and displays "<<<>>>" on the screen.</p>

Note: If you have defined an entry side and/or an exit side, at least one value pair must lie inside the window. If this is not the case, the DIGIFORCE[®] 9311 assesses the window with an NOK result.

Absolute maximum

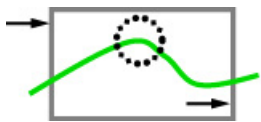
Symbol	Window evaluation element
	<p>The DIGIFORCE[®] 9311 determines the absolute maximum of the Y-value between entry and exit points as an X/Y value pair.</p> <p>The DIGIFORCE[®] 9311 only considers curve points inside the window when finding this value.</p>

Absolute minimum

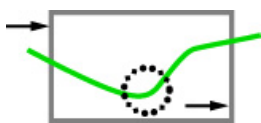
Symbol	Window evaluation element
	<p>The DIGIFORCE[®] 9311 determines the absolute minimum of the Y-value between entry and exit points as an X/Y value pair.</p> <p>The DIGIFORCE[®] 9311 only considers curve points inside the window when finding this value.</p>

Configuring an evaluation window / Window configuration



This is how it works

- 1 Click on the "Evaluation" tab.
- 2 Click on "Meas curves (measure, load, save)" and either use **[Load]** to load existing measurement curves or **[Start]** to begin recording measurement curves. Perform one or more measurements. At the end of the measurement click **[Stop]**.
- 3 Click on **[Window]** and enable the "Window On" checkbox.

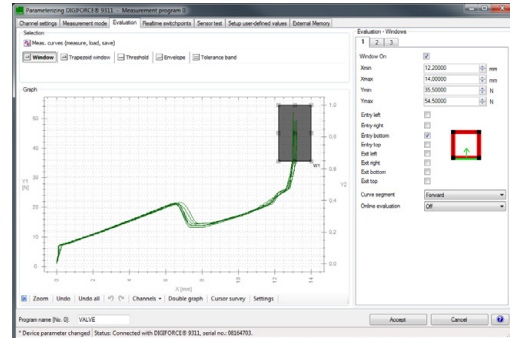

- 4 You have the option to use the mouse cursor or coordinates ("Xmin", "Xmax", "Ymin", "Ymax") to position your window.
- 5 Select the entry and exit sides of the window with the relevant directions by enabling the corresponding checkboxes. More than one entry side is also allowed.

Note: If no side is defined at all, the curve can lie entirely inside the window or entirely outside the window ("NOT window")
- 6 Select the "Curve segment" from the drop-down menu ("Forward", "Return" or "Complete curve").

Note: Take care that you set the correct curve segment for which the window is active. For instance, if the return point of a forward and return curve lies in the window area, the "Complete curve" option must be selected for the curve segment.
- 7 If required, select "Online evaluation". You can only enable this option for one window. You are then offered the choice of "Off", "Left > Right", "Right > Left", "Bottom > Top" and "Top > Bottom".

With Online evaluation enabled, the DIGIFORCE® 9311 switches the online signal ("OUT_NOK_ONL") to active level immediately on detecting that the curve has exited the window incorrectly.

Note: Enabling Online evaluation will change the entry/exit sides previously defined. Enabling Online evaluation is not relevant for the "Final force" or "Crossing reference line" reference. When these references are used, the measurement curve is recalculated and repositioned after the measurement. The live behavior of the Online evaluation is based on the absolute X-reference in these cases.
- 8 If you have selected Online evaluation, you can use "Online Signal" to define the signal activity of the PLC I/O signal. You can choose either active low ("Low active") or active high ("High active").
- 9 Select tabs **[2]** or **[3]** to configure additional windows.
- 10 Click **[Accept]**.

Parameters in "Evaluation - Windows"

Window number	1 to 3	Choice of window 1, 2 or 3
Window	On / Off	Enable / Disable
Xmin	<value input>	Window position coordinate Xmin
Xmax	<value input>	Window position coordinate Xmax
Ymin	<value input>	Window position coordinate Ymin
Ymax	<value input>	Window position coordinate Ymax
Entry	Left, Right Bottom, Top	Side at which the curve enters the window Possible options: <ul style="list-style-type: none"> • one entry side • more than one entry side • no entry
Exit	Left, Right Bottom, Top	Side at which the curve exits the window Possible options: <ul style="list-style-type: none"> • one exit side • more than one exit side • no exit Note: If no side is defined at all, the curve is allowed to lie entirely inside the window or entirely outside the window ("NOT window")
Curve segment	Forward, Return, Complete curve	Specify the curve segment for which the window is active.
Online evaluation	Off Left > Right Right > Left Bottom > Top Top > Bottom	With Online evaluation enabled, the associated online signal goes to active level immediately it is detected that the curve has exited the window incorrectly. Note: Enabling Online evaluation will change the entry/exit sides previously defined. Online evaluation of the "Window" graphical evaluation element is only relevant for the "Absolute" and "Crossing trigger threshold" references. When the "Final force" or "Crossing reference line" reference is used, the measurement curve is recalculated and repositioned after the measurement. In these cases, the online evaluation uses the absolute X-reference for its live response.
Online signal	High active Low active	Active signal level of the PLC I/O signal ("OUT_NOK_ONL")

6.3.2.7.2 Trapezoid window

You can set the "Trapezoid window" graphical evaluation element to be of type "Trapezoid X" or "Trapezoid Y". The "Trapezoid X" type is specified by fixed vertical X limits (Xmin, Xmax) and the "Trapezoid Y" type by fixed horizontal Y limits (Ymin, Ymax). You can configure up to two trapezoid windows in one measurement program. At the end of the measurement phase, the DIGIFORCE® 9311 outputs an OK/NOK result and calculates the entry and exit coordinates for each trapezoid.

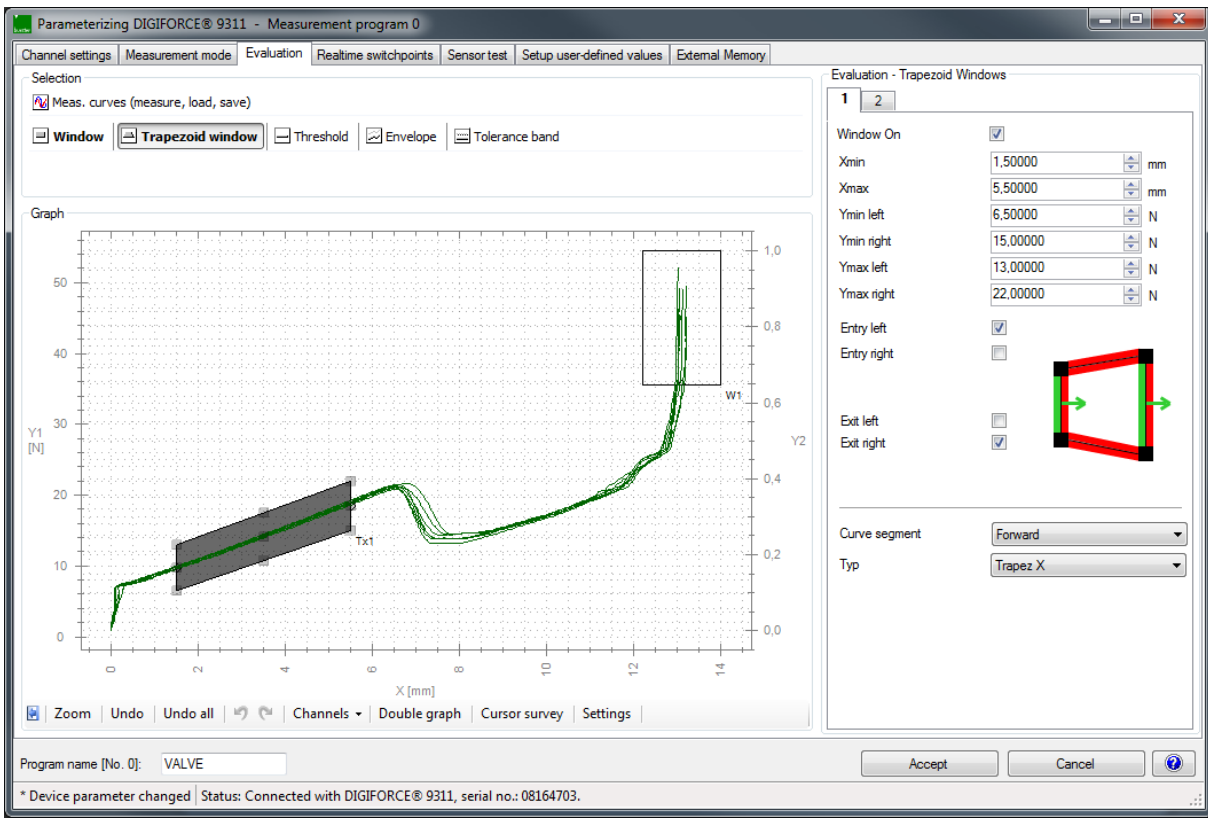

Diagram 49: Trapezoid window evaluation element

Unlike a "Window", the measurement curve is allowed to cross a "Trapezoid window" only at the vertical sides (Trapezoid X) or only at the horizontal sides (Trapezoid Y).

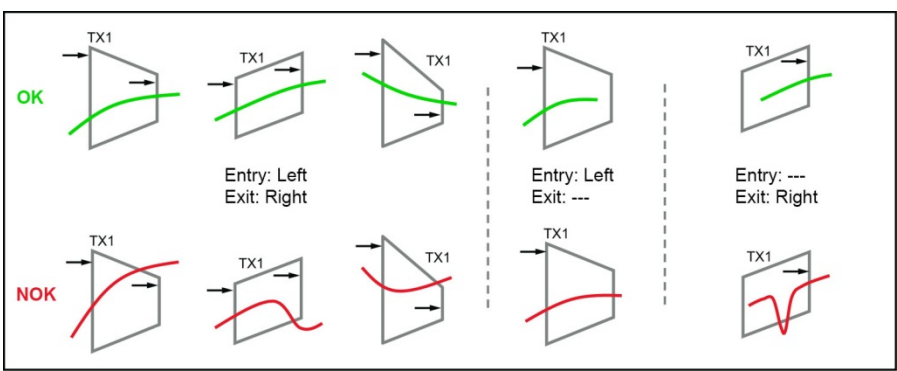

Diagram 50: Trapezoid window type Trapezoid X

DIGIFORCE[®] model 9311

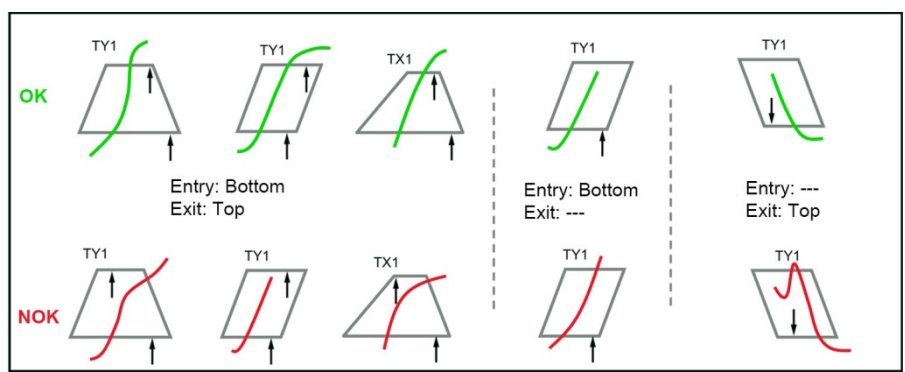



Diagram 51: Trapezoid window type Trapezoid Y

Whatever its orientation, the "Trapezoid window" graphical evaluation element outputs the following results data:

Individual evaluation

	or		<p>The DIGIFORCE[®] 9311 can also output the evaluation result from a single trapezoid at the Fieldbus interface.</p>
---	----	---	--

Entry

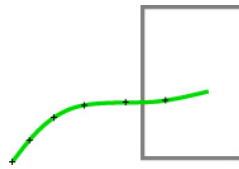
Symbol	Trapezoid evaluation element
	<p>The DIGIFORCE[®] 9311 linearly interpolates the trapezoid entry coordinates from the last measurement point outside the trapezoid and the first measurement point inside the trapezoid.</p> <p>If the measurement curve starts inside the trapezoid area, the DIGIFORCE[®] 9311 outputs the first measurement point (start value).</p> <p>If the entire measurement curve lies outside the trapezoid area, the DIGIFORCE[®] 9311 indicates/outputs the value pair 909090/909090 and displays "<<<>>>" on the screen.</p>

Exit

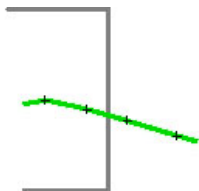
Symbol	Trapezoid evaluation element
	<p>The DIGIFORCE[®] 9311 linearly interpolates the trapezoid exit coordinates from the last measurement point inside the trapezoid and the first measurement point outside the trapezoid.</p> <p>If the measurement curve ends inside the trapezoid area, the DIGIFORCE[®] 9311 outputs the last measurement point.</p> <p>If the entire measurement curve lies outside the trapezoid area, the DIGIFORCE[®] 9311 indicates/outputs the value pair 909090/909090 and displays "<<<>>>" on the screen.</p>

Note: If you have defined an entry side and/or an exit side, at least one value pair must lie inside the trapezoid. If this is not the case, the DIGIFORCE[®] 9311 assesses the trapezoid with an NOK result.

Configuring a trapezoid window



This is how it works

- 1 Click on **[Trapezoid window]** and enable the "Window On" checkbox.
If you have not measured any measurement curves yet, click on "Meas curves (measure, load, save)" and either use **[Load]** to load existing measurement curves or **[Start]** to begin recording measurement curves. Perform one or more measurements. At the end of the recording click **[Stop]**.

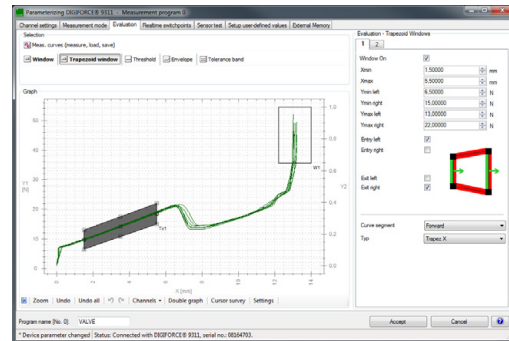

- 2 Select the type of trapezoid window from the drop-down menu ("Trapezoid X" or "Trapezoid Y").
Note: For trapezoid windows in the Y-direction, you can only choose between top and bottom as the entry or exit side.
- 3 You have the option to use the mouse cursor or coordinates ("Xmin", "Xmax", "Ymin left", "Ymin right", "Ymax left" and "Ymax right") to position your trapezoid window.
- 4 Select the entry and exit sides of the trapezoid window with the relevant directions by enabling the corresponding checkboxes.
- 5 Select the "Curve segment" from the drop-down menu ("Forward", "Return" or "Complete curve").
Note: Take care that you set the correct curve segment for which the trapezoid window is active. For instance, if the return point of a forward and return curve lies in the trapezoid window area, the "Complete curve" option must be selected for the curve segment.
- 6 Select tab **[2]** to configure another trapezoid window.
- 7 Click **[Accept]**.

Parameters in "Evaluation – Trapezoid Windows"

Number	1 or 2	Choice of trapezoid window 1 or 2
Window	On / Off	Enable / Disable
Type	Trapezoid X, Trapezoid Y	Select the trapezoid type
Curve segment	Forward, Return, Complete curve	Specify the curve segment for which the trapezoid window is active.
Trapezoid of type X		
Xmin	<value input>	Trapezoid position coordinate Xmin
Xmax	<value input>	Trapezoid position coordinate Xmax
YminLe	<value input>	Trapezoid position coordinate Ymin Left
YminRi	<value input>	Trapezoid position coordinate Ymin Right
YmaxLe	<value input>	Trapezoid position coordinate Ymax Left

YmaxRi	<value input>	Trapezoid position coordinate Ymax Right
Entry	Left, Right	Side at which the curve enters the X trapezoid Possible options: <ul style="list-style-type: none"> • one entry side • more than one entry side • no entry
Exit	Left, Right	Side at which the curve exits the X trapezoid Possible options: <ul style="list-style-type: none"> • one exit side • more than one exit side • no exit
Trapezoid of type Y		
Ymin	<value input>	Trapezoid position coordinate Ymin
Ymax	<value input>	Trapezoid position coordinate Ymax
XminBo	<value input>	Trapezoid position coordinate Xmin Bottom
XminTo	<value input>	Trapezoid position coordinate Xmin Top
XmaxBo	<value input>	Trapezoid position coordinate Xmax Bottom
XmaxTo	<value input>	Trapezoid position coordinate Xmax Top
Entry	Bottom, Top	Side at which the curve enters the Y trapezoid Possible options: <ul style="list-style-type: none"> • one entry side • more than one entry side • no entry
Exit	Bottom, Top	Side at which the curve exits the Y trapezoid Possible options: <ul style="list-style-type: none"> • one exit side • more than one exit side • no exit

6.3.2.7.3 Threshold

The "Threshold" graphical evaluation element can be used to calculate and monitor the point at which the measurement curve passes through a defined X-value or Y-value. The DIGIFORCE® 9311 classifies "Thresholds" as two different types. The "X threshold" type is positioned at a set X-value as a vertical line for which you can define the range of Y-values (Ymin to Ymax)

For the "Y threshold" type the situation is exactly the opposite; the threshold is fixed at a set Y-value as a horizontal line for which you can define the range of X-values (Xmin to Xmax). You can use up to two thresholds in one measurement program.

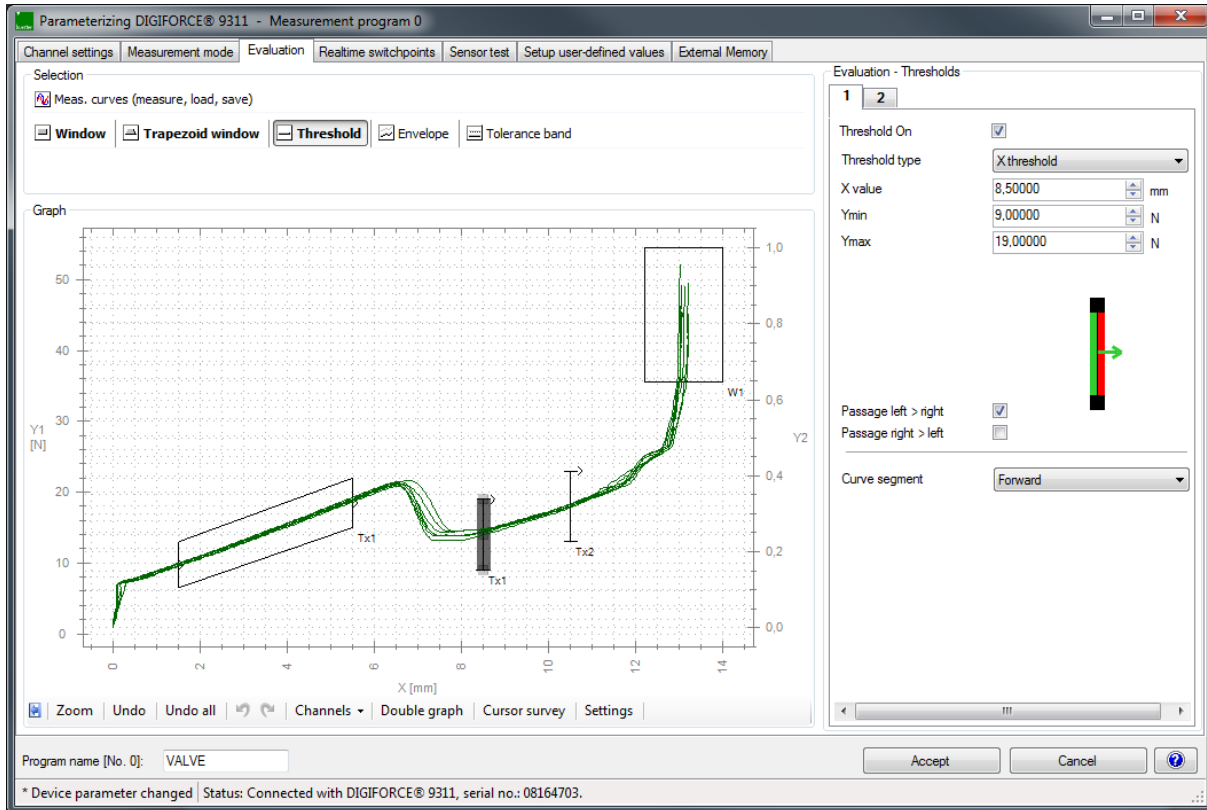

Diagram 52: Evaluation element Threshold

Thresholds provide an OK/NOK result at the end of the measurement phase. If the curve crosses the threshold, the DIGIFORCE® 9311 additionally calculates the coordinates of the crossover point.

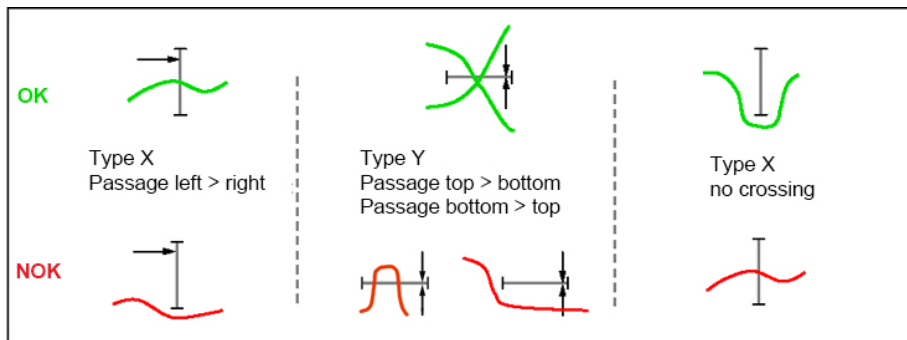



Diagram 53: Thresholds (examples)

Note: The curve must pass through the "Threshold" evaluation element only once.

DIGIFORCE® model 9311

The "Threshold" graphical evaluation element outputs the following results data:

Individual evaluation

 or 	The DIGIFORCE® 9311 can also output the evaluation result from a single threshold at the Fieldbus interface.
--	--

Crossing (intersection of measurement curve and threshold)

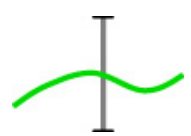
Symbol	Threshold evaluation element
	<p>The DIGIFORCE® 9311 linearly interpolates the crossing point from the last measurement point before the threshold and the first measurement point after the threshold.</p> <p>If the DIGIFORCE® 9311 cannot ascertain that the threshold has been crossed, it indicates/outputs the value pair 909090/909090 and displays "<<<>>>" on the screen.</p>

Configuring a threshold



This is how it works

- 1 Click on **[Threshold]** and enable the "Threshold On" checkbox.
If you have not measured any measurement curves yet, click on "Meas curves (measure, load, save)" and either use **[Load]** to load existing measurement curves or **[Start]** to begin recording measurement curves. Perform one or more measurements. At the end of the measurement click **[Stop]**.

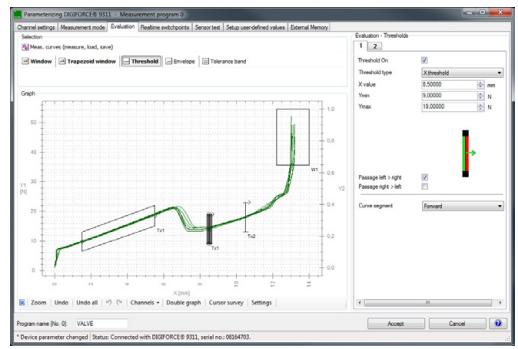

- 2 Select the "Threshold type" from the drop-down menu ("X threshold" or "Y threshold").
- 3 You have the option to use the mouse cursor or coordinates ("X value" or "Y value", "Ymin" or "Xmin" and "Ymax" or "Xmax" respectively, depending on the threshold type).
- 4 Select the crossing direction you require by enabling the checkbox beside the corresponding passage direction.
Note: The curve must pass through the "Threshold" evaluation element only once. You can also define that the measurement curve shall not cross the threshold. If this condition is breached, the DIGIFORCE® 9311 gives the measurement an NOK evaluation.
- 5 Select the "Curve segment" from the drop-down menu ("Forward", "Return" or "Complete curve").
- 6 Select tab **[2]** to configure another threshold.
- 7 Click **[Accept]**.

Parameters in "Evaluation - Thresholds"

Threshold number	1 to 2	Choice of threshold 1 or 2
Threshold	On / Off	Enable / Disable
Threshold type	X threshold Y threshold	Select whether the threshold is type X or type Y
X-value, Y-value	<value input>	For a type X threshold: X-position of the X threshold. For a type Y threshold: Y-position of the Y threshold.
Xmin / Ymin	<value input>	For a type X threshold: Lower Y limit Ymin. For a type Y threshold: Left-hand X limit Xmin.
Xmax / Ymax	<value input>	For a type X threshold: Upper Y limit Ymax. For a type Y threshold: Right-hand X limit Xmax.
Crossing	Left > Right Right > Left Bottom > Top Top > Bottom	Select the direction in which the curve crosses the threshold Possible options: <ul style="list-style-type: none"> • does not cross • crosses from one side • crosses from either side Note: Crossing from either side means either from left to right (bottom to top) or from right to left (top to bottom).
Curve segment	Forward, Return, Complete curve	Specify the curve segment for which the threshold is active.

6.3.2.7.4 Envelope

The DIGIFORCE® 9311 can generate from one or more measurement curves an "envelope" for each measurement program.

You can generate an "Envelope" only if you use at least one existing measurement curve as the basis for the envelope. Once you have generated the envelope, you can then adjust its position along the X-axis or Y-axis as required and also set the respective expanded Y/X tolerance band (Delta Ymin/max and Delta Xmin/max respectively).

Note: For a measurement curve comprising a forward and return curve section, the envelope cannot lie over the turning point.

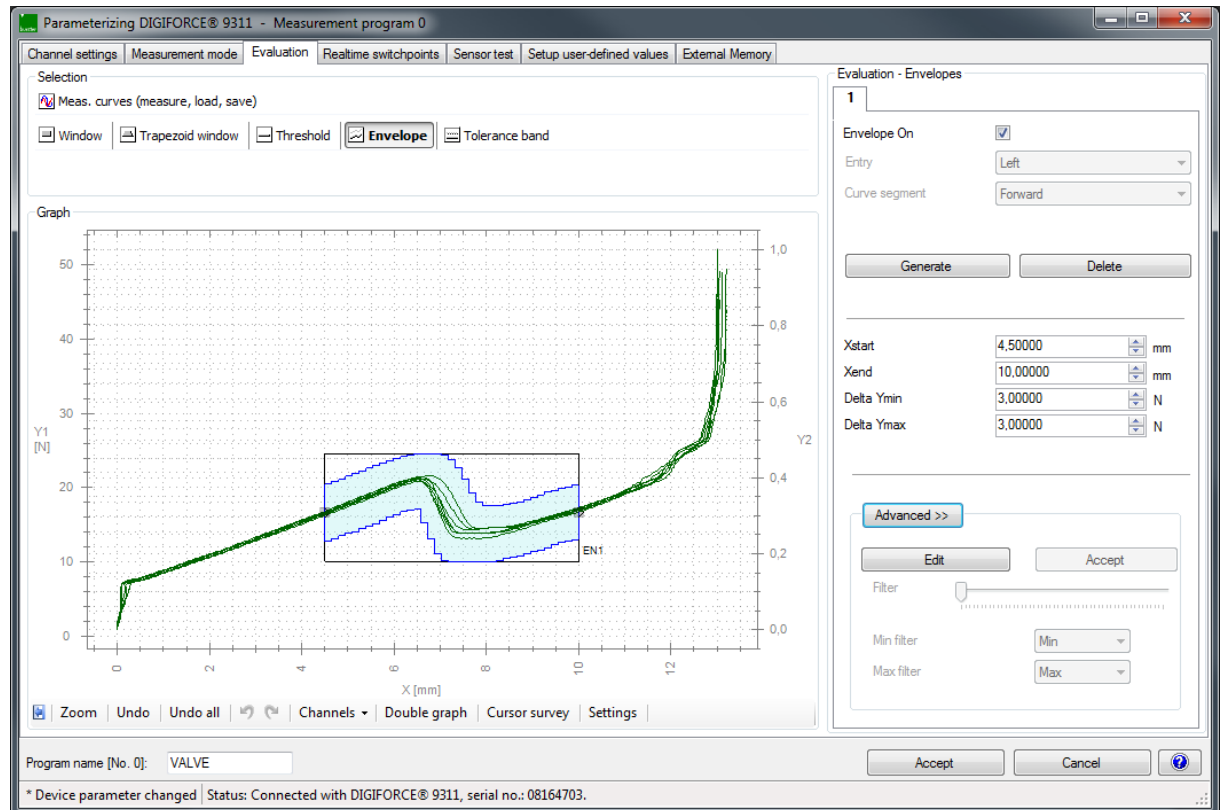

Diagram 54: Envelope evaluation element

Note: The envelope can be generated only if the entire curve segment (forward or return) is continuous, i.e. for Left or Right entry, only one Y-value must be associated with each X-coordinate, or for Bottom or Top entry, only one X-value must be associated with each Y-coordinate; otherwise an error message is displayed.

Note: The measurement curves needed for generating an envelope can also be loaded from previously saved measurement log files.

In measurement mode, the DIGIFORCE® 9311 checks whether the measurement curve lies within the defined band of the envelope. If so, the measurement curve is evaluated as OK. If, however, the measurement curve should cross at least once outside the area of the "envelope", the DIGIFORCE® 9311 evaluates the measurement curve as NOK.

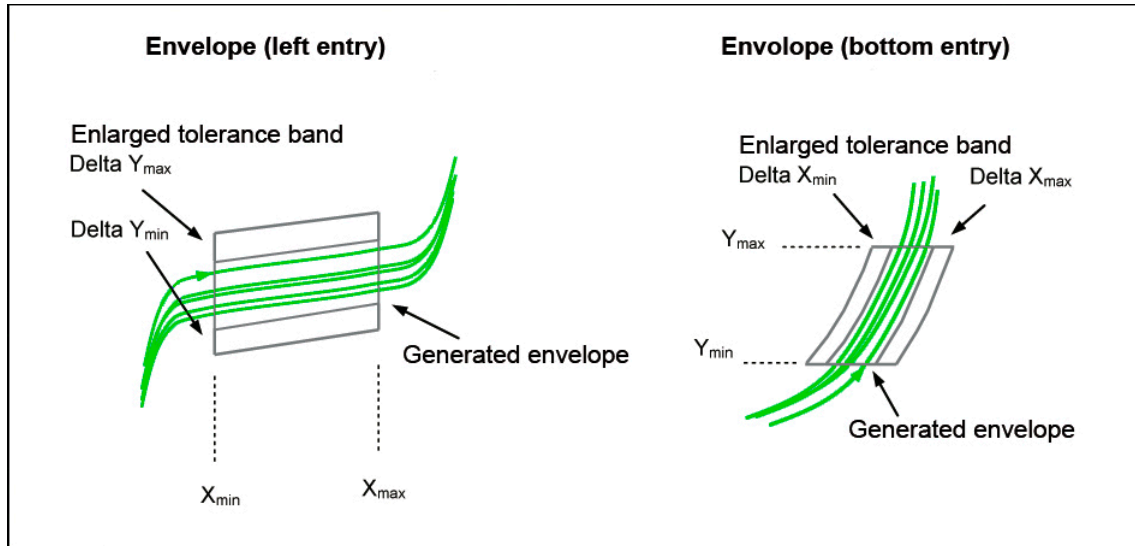
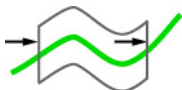
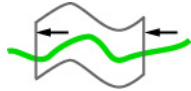



Diagram 55: Envelopes

Examples of envelopes

Symbol	Description
	Envelope with curve crossing from "Left" to "Right".
	Envelope with curve crossing from "Right" to "Left".
	Envelope with curve crossing from "Bottom" to "Top".

DIGIFORGE® model 9311

Configuring a threshold



This is how it works

- 1 Click on the "Evaluation" tab.
- 2 Click on "Meas curves (measure, load, save)" and either use **[Load]** to load existing measurement curves or **[Start]** to begin recording measurement curves. Perform one or more measurements. At the end of the measurement click **[Stop]**.
- 3 Click on **[Envelope]** and enable the "Envelope On" checkbox. Then click on **[Generate]**.

Note: You need at least one measurement curve to generate an "Envelope".

Note: The envelope can be generated only if the entire curve segment (forward or return) is continuous, i.e. for Left or Right entry, only one Y-value must be associated with each X-coordinate, or for Bottom or Top entry, only one X-value must be associated with each Y-coordinate; otherwise an error message is displayed.

- 4 The following pop-up window appears. Click **[OK]**.

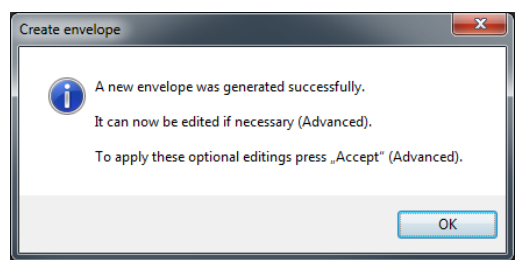
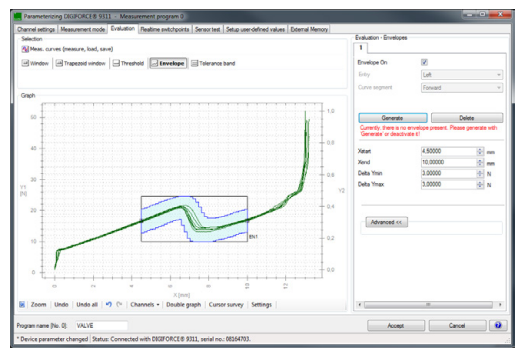

- 5 Use the coordinates ("Xstart" and "Xend") to position your envelope.

Note: There is often a large amount of scatter in the edge regions Xmin and Xmax of the measurement curve (e.g. in block entry). We therefore recommend that you do not let the Xstart and Xend parameters of the envelope extend into these edge regions. Instead, reduce the range covered by the envelope.

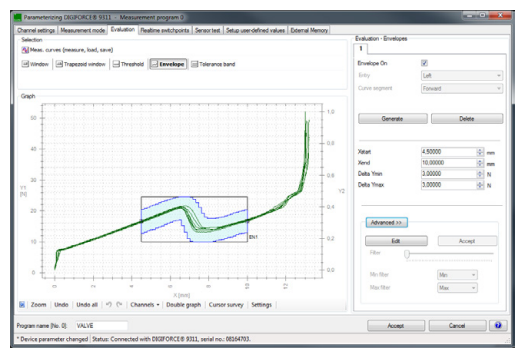

- To increase the envelope tolerance use the parameters "Delta Ymin" and "Delta Ymax" (or respectively "Delta Xmin" and "Delta Xmax" for bottom and top entry).

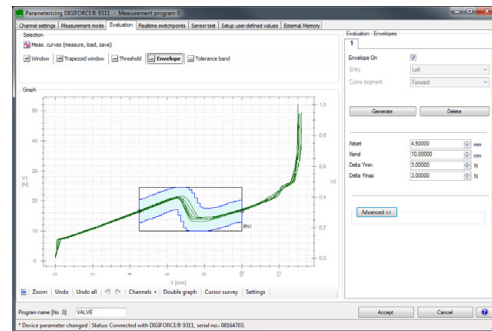

- Click [**Accept**].

Note: You can use the "Advanced" button to set curve points in order to make further adjustments to the envelope shape. This lets you enlarge individual critical regions within tightly defined ranges, whereas the standard adjustment applies as a whole to the entire curve.

Parameters in "Evaluation - Envelopes"

Envelope	On / Off	Enable / Disable
Entry	Left, Right, Top, Bottom	Specify the direction in which the curve passes through the envelope
Curve segment	Forward, Return	Specify the curve segment for which the envelope is active.
Xstart / Ystart	<value input>	Specify the start position of the envelope.
Xend / Yend	<value input>	Specify the end position of the envelope.
Delta Ymin / Xmin	<value input>	Specify the minimum value of the expanded tolerance band, Delta X/Ymin.
Delta Ymax / Xmax	<value input>	Specify the maximum value of the expanded tolerance band, Delta X/Ymax.
Advanced	Edit / Cancel / Accept	Selection
Filter	Slide bar	
Min filter	Min, Max, Mean, Median	
Max filter	Min, Max, Mean, Median	

IMPORTANT: The DIGIFORCE[®] 9311 can only generate an "Envelope" if the entire curve segment (forward or return) runs in a continuous direction i.e. for a Left or Right entry, only one Y-value must be associated with each X-coordinate, or for a Bottom or Top entry, only one X-value must be associated with each Y-coordinate.

If an error is displayed ("Measurement curve(s) not continuous") when generating the envelope, you can usually obtain a smoother curve by making suitable filter settings or reducing the sampling. Delete the measurement curves that you previously recorded.

6.3.2.7.5 Tolerance band for evaluation elements

You can use the tolerance band for graphical evaluation elements to configure an additional hysteresis region at the boundaries of the element, so for instance at the entry and exit side of a window. In this hysteresis band, the measurement curve can cross back and forth across the boundary line of the graphical evaluation element any number of times without resulting in an NOK evaluation. For example, if a machine exhibits unwanted mechanical behavior such as vibrations, or slip-stick phenomena arise in a hydraulic system, then this will intermittently result in fluctuations or outliers in the recorded measurement curve. If these fluctuations occur at the boundaries of an evaluation window, the DIGIFORCE® 9311 will evaluate the measurement as NOK if it detects that the curve repeatedly enters and exits the window. By setting a tolerance band, however, the DIGIFORCE® 9311 will give an OK evaluation provided the curve fluctuation lies within this hysteresis band.

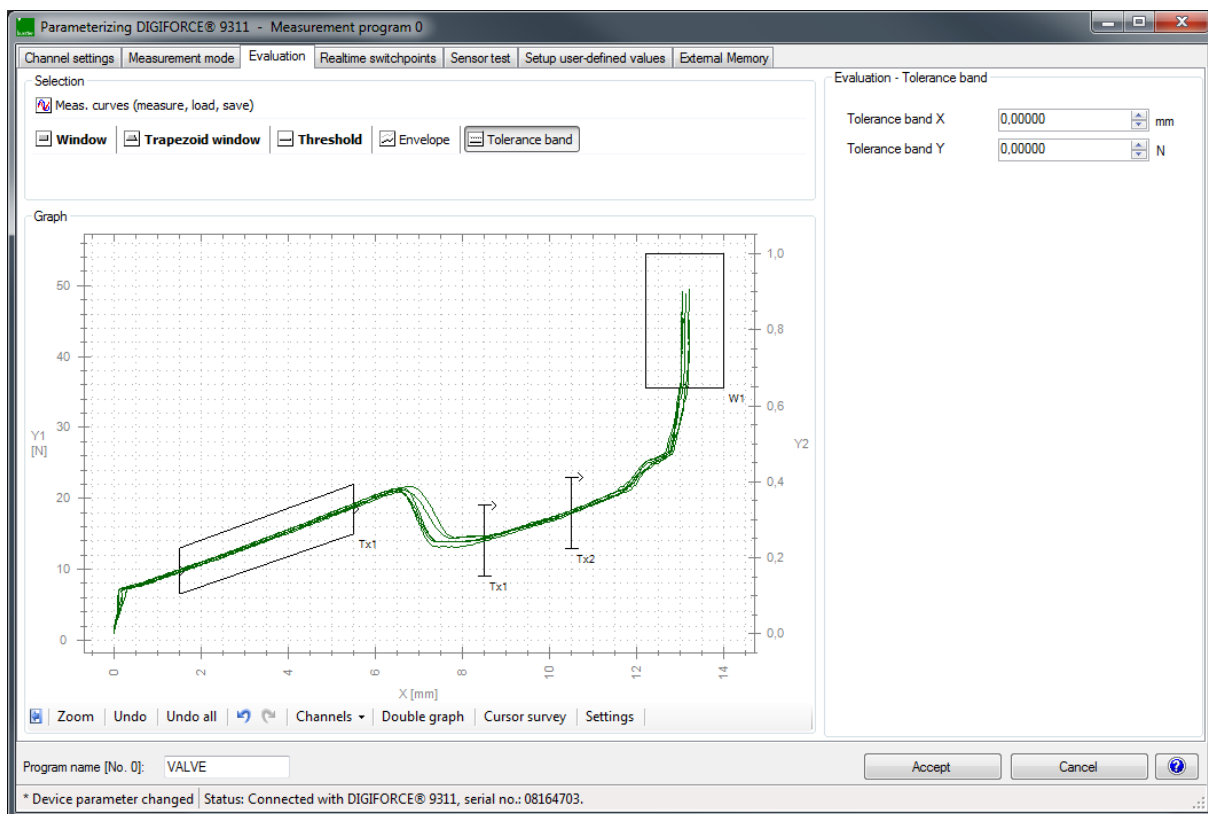

Diagram 56: Tolerance band for evaluation elements

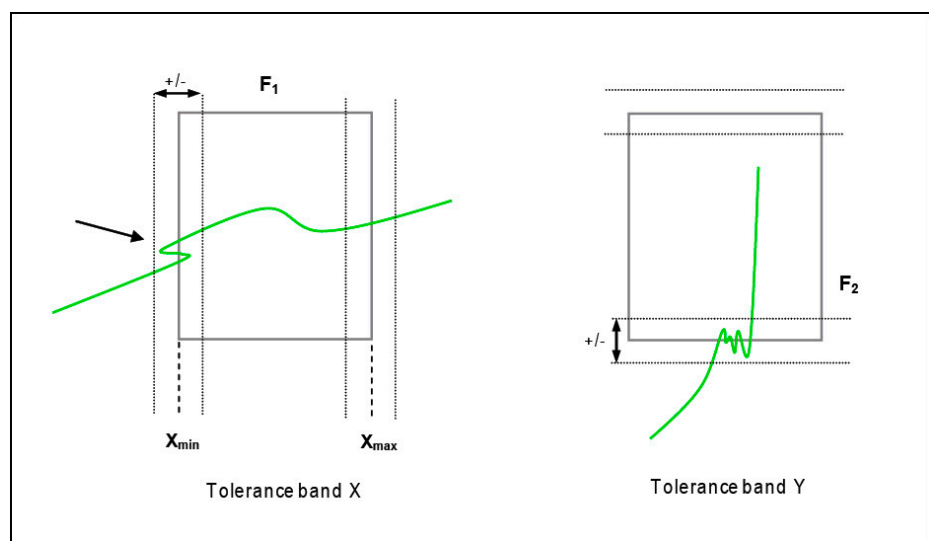
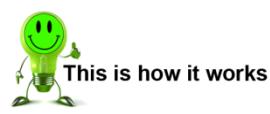

Diagram 57: Tolerance band

Note: The Tolerance band X and Y parameters apply to all the graphical evaluation elements together. They cannot be defined for just one specific graphical evaluation element. Note that when a tolerance band is enabled (Tolerance band X or Y > 0), the measurement curve must pass through the area of the graphical evaluation element plus the tolerance value.

Configuring a tolerance band



- 1 Click **[Tolerance band]**.
Note: The Tolerance band X and Y parameters apply to all the graphical evaluation elements. They cannot be defined for just one specific graphical evaluation element. Note that when a tolerance band is enabled (Tolerance band X or Y > 0), the measurement curve must pass through the area of the graphical evaluation element plus the tolerance value.

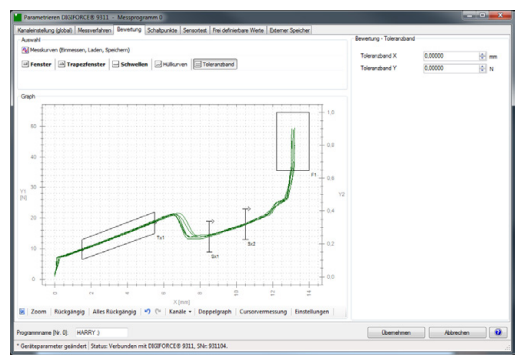

- 2 Define the hysteresis region using Tolerance band X and Tolerance band Y.
- 3 Click **[Accept]**.

Parameters in "Evaluation – Tolerance band"

Tolerance band X	<value input>	Define the hysteresis band in the X-axis direction
Tolerance band Y	<value input>	Define the hysteresis band in the Y-axis direction

6.3.2.8 Online switching points

WARNING

NOT a substitute for safety devices and protective equipment

The online switching signals S1 to S6 are NOT a substitute for safety devices and protective equipment.

Use safety devices and protective equipment.

Note: The switching signals S1 to S6 do not meet the requirements for a safety switch. It is the responsibility of the owner of the complete system, such as a press, to equip the system with the required safety devices and protective equipment.

Note: Outputs S1 and S2 are permanently assigned to specific PLC outputs. The assignment for outputs S3 to S6 can be custom-set (see section 6.3.4.1 “PLC outputs” on page 105).

The six switching signals S1 to S6 at the PLC I/O interface and/or Fieldbus interface can be used for signaling in real time if a limit has been exceeded. Under "Realtime switchpoints" you can assign the six signals to the active measurement channels X or Y and set the limit threshold. You can also select for each I/O signal whether it is active high or active low.

The limit thresholds for the X measurement channel can refer to the absolute measurement signal or to the relative zero point (Measurement mode reference: Y trigger).

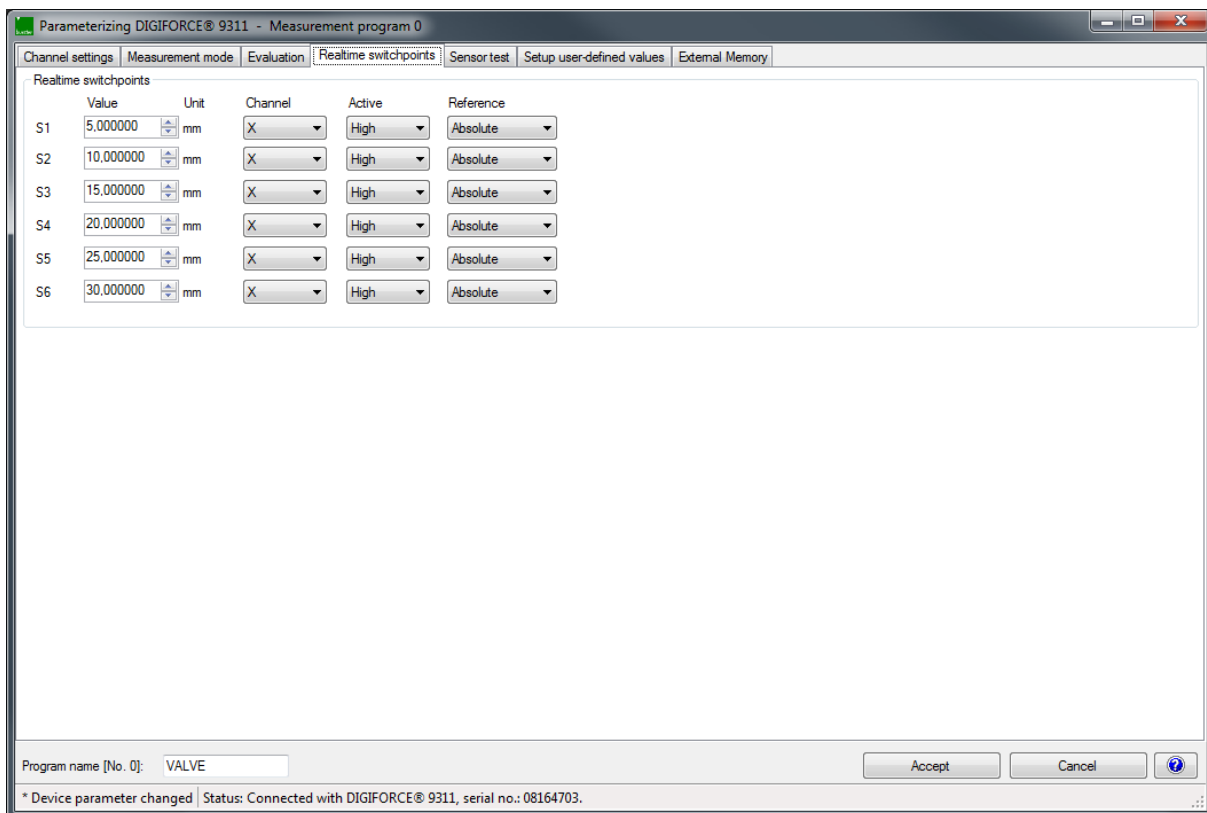

Diagram 58: Realtime switchpoints

Parameters in "Realtime switchpoints S1 ... S6"

Value	Limit threshold	Enter the limit threshold
Unit	Unit display	Displays the units for the measurement channel
Channel	X, Y	Select the active measurement channel for the respective switching signals S1 to S6
Active	High / Low	Select whether signal is active high or active low
Reference	Absolute / Y-trigger	<p>Reference for measurement channel X</p> <p>Absolute: The limit threshold is referred to the absolute value of measurement channel X.</p> <p>Y-trigger: The limit threshold is referred to the trigger event (for further details, please see section 6.3.2.6 "Measurement mode" on page 69).</p> <p>Note: You can only select the Y trigger reference if crossing the Y trigger threshold is set as the "Reference" parameter in the "Measurement mode" menu.</p>

Note: Outputs S1 and S2 are permanently assigned to specific PLC outputs. The assignment for outputs S3 to S6 can be custom-set (see section 6.3.4.1 "PLC outputs" on page 105).

6.3.2.9 Sensor test

The "Sensor test" function can be used for cyclical testing of the active measurement channels. In the test, the DIGIFORCE® 9311 compares the live measurements with stored reference values. The DIGIFORCE® 9311 evaluates the result as "sensor test OK/NOK" depending on whether or not the measured value lies within the defined tolerance; for details please see section 3.8 "Sensor test" on page 19. The "Sensor test" can be launched using the "IN_STEST" control signal or a configurable function key.

Parameters for channel X and Y in "Sensor test"

Sensor test	On / Off	Enable / Disable
Measured value	<value> or <value input>	Reference value measured for the sensor test. This value is used as the comparison value when running the sensor test. If the value measured during the sensor test lies within the permitted tolerance, the control signal "OUT_OK_STEST" is set to 1 (sensor test OK). If the value lies outside the permitted tolerance, then "OUT_OK_STEST" = 0 (sensor test NOK).
Max allowed deviation [±]	<value input>	Set here the permitted +/- tolerance for the OK/NOK decision of the sensor test.

Running the sensor test

You can initiate the sensor test via the PLC I/O control interface or the Fieldbus interface using the "IN_STEST" signal (please see section 10.7 "External actuation of a sensor test" on page 157).

Note: Do not run the cyclical "tare" function and "sensor test" at the same reference value e.g. at the reference position on a machine. If you were to do this, the tare action would prevent reliable identification of any potential sensor fault or sensor drift.

6.3.2.10 User-defined values

The "Setup user-defined values" menu lets you transfer up to 20 measurement results of your choice via an optional Fieldbus interface in the real-time process channel. The results are available immediately after the measurement with the "READY" status. These results are also read and logged in the DigiControl Measurement data logging facility (laboratory mode or automatic measurement mode function). These measurement results include, for instance, entry and exit values for the graphical evaluation elements. Before the DIGIFORCE® 9311 can display any of these values, they need to be enabled in the "Setup user-defined values" tab. You can enable up to 20 values.

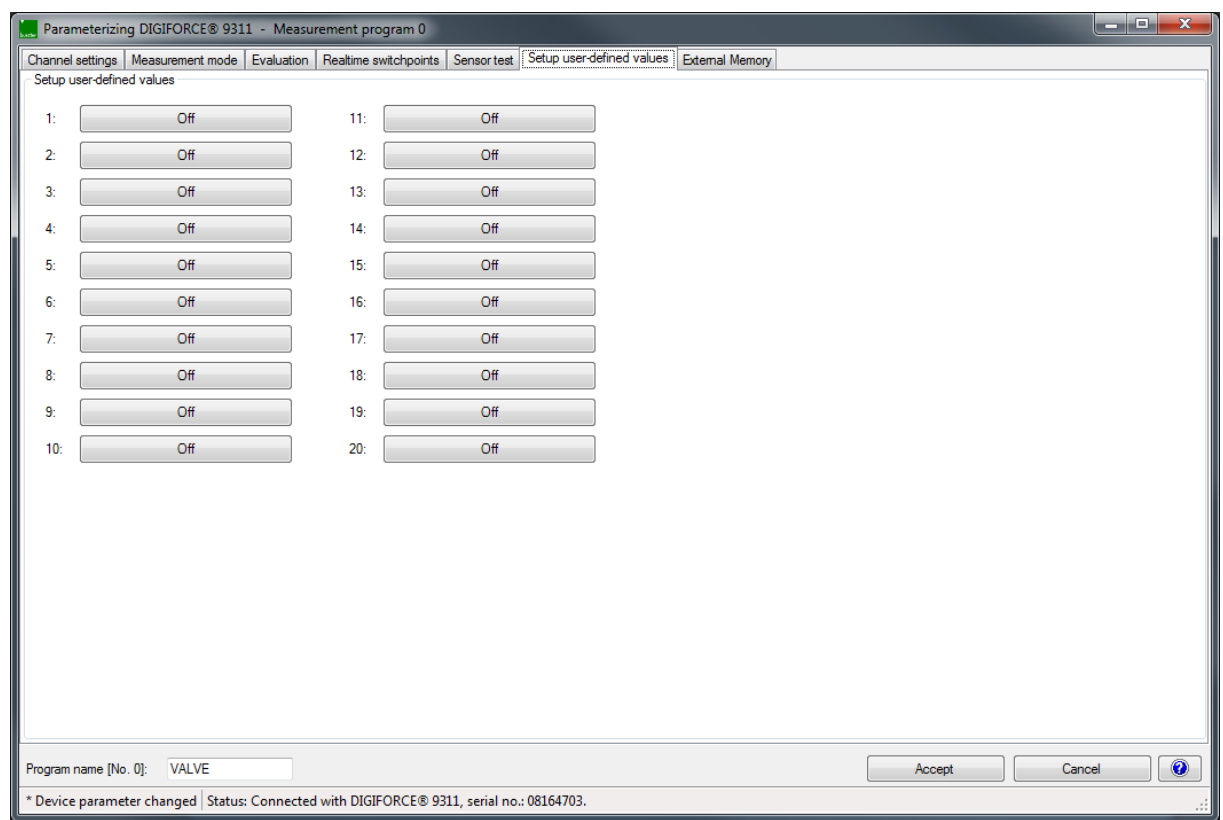

Diagram 59: User-defined values

Note: The "User-defined values" list can be used not only to transfer measurement results but also the tolerance limits for the evaluation elements (e.g. "Window" evaluation element). This allows the currently allowed tolerance to be logged alongside a measured value (e.g. window entry value). This improves a later statistical analysis of the process reliability and means that any change in tolerance limits can be saved and monitored.

The following values are available for selection:

General curve data

Start X	First measured value of the measurement curve – X-coordinate
Start Y	First measured value of the measurement curve – Y-coordinate
End X	Last measured value of the measurement curve – X-coordinate
End Y	Last measured value of the measurement curve – Y-coordinate
AbsMaxX (X)	Absolute maximum of entire measurement curve for X-channel – X-coordinate
AbsMaxX (Y)	Absolute maximum of entire measurement curve for X-channel – Y-coordinate

AbsMinX (X)	Absolute minimum of measurement curve for X-channel – X-coordinate
AbsMinX (Y)	Absolute minimum of measurement curve for X-channel – Y-coordinate
AbsMaxY (X)	Absolute maximum of measurement curve for Y-channel – X-coordinate
AbsMaxY (Y)	Absolute maximum of measurement curve for Y-channel – Y-coordinate
AbsMinY (X)	Absolute minimum of measurement curve for Y-channel – X-coordinate
AbsMinY (Y)	Absolute minimum of measurement curve for Y-channel – Y-coordinate
Return point X	Return point of measurement curve – X-coordinate
Return point Y	Return point of measurement curve – Y-coordinate

Window (1 ... 3)

$W_{1/2/3}$ Entry X	Window entry value – X-coordinate
$W_{1/2/3}$ Entry Y	Window entry value – Y-coordinate
$W_{1/2/3}$ Exit X	Window exit value – X-coordinate
$W_{1/2/3}$ Exit Y	Window exit value – Y-coordinate
$W_{1/2/3}$ AbsMin X	Absolute minimum for Y-channel inside window – X-coordinate
$W_{1/2/3}$ AbsMin Y	Absolute minimum for Y-channel inside window – Y-coordinate
$W_{1/2/3}$ AbsMax X	Absolute maximum for Y-channel inside window – X-coordinate
$W_{1/2/3}$ AbsMax Y	Absolute maximum for Y-channel inside window – Y-coordinate
$W_{1/2/3}$ Pos Xmin	Window boundary, Xmin
$W_{1/2/3}$ Pos Xmax	Window boundary, Xmax
$W_{1/2/3}$ Pos Ymin	Window boundary, Ymin
$W_{1/2/3}$ Pos Ymax	Window boundary, Ymax

Trapezoid window (1 ... 2)

$TW_{1/2}$ Entry X	Trapezoid entry value – X-coordinate
$TW_{1/2}$ Entry Y	Trapezoid entry value – Y-coordinate
$TW_{1/2}$ Exit X	Trapezoid exit value – X-coordinate
$TW_{1/2}$ Exit Y	Trapezoid exit value – Y-coordinate
Trapezoid of type X	
$TW_{1/2}$ Pos Xmin	Trapezoid boundary (type X), Xmin
$TW_{1/2}$ Pos Xmax	Trapezoid boundary (type X), Xmax
$TW_{1/2}$ Pos YminLe	Trapezoid boundary (type X), YminLeft
$TW_{1/2}$ Pos YmaxLe	Trapezoid boundary (type X), YmaxLeft
$TW_{1/2}$ Pos YminRi	Trapezoid boundary (type X), YminRight

TW _{1/2} Pos YmaxRi	Trapezoid boundary (type X), YmaxRight
Trapezoid of type Y	
TW _{1/2} Pos Ymin	Trapezoid boundary (type Y), Ymin
TW _{1/2} Pos Ymax	Trapezoid boundary (type Y), Ymax
TW _{1/2} Pos XminBo	Trapezoid boundary (type Y), XminBottom
TW _{1/2} Pos XmaxBo	Trapezoid boundary (type Y), XmaxBottom
TW _{1/2} Pos XminTo	Trapezoid boundary (type Y), XminTop
TW _{1/2} Pos XmaxTo	Trapezoid boundary (type Y), XmaxTop

Threshold (1 ... 2)

TH _{1/2} Pass X	Threshold crossing point (intersection) – X-coordinate
TH _{1/2} Pass Y	Threshold crossing point (intersection) – Y-coordinate
Type X threshold	
TH _{1/2} Pos Threshold	X-position of threshold
TH _{1/2} Pos Ymin	Limit of threshold, Ymin
TH _{1/2} Pos Ymax	Limit of threshold, Ymax
Type Y threshold	
TH _{1/2} Pos Threshold	Y-position of threshold
TH _{1/2} Pos Xmin	Limit of threshold, Xmin
TH _{1/2} Pos Xmax	Limit of threshold, Xmax

Envelope

EN Entry X	Envelope entry value – X-coordinate
EN Entry Y	Envelope entry value – Y-coordinate
EN Exit X	Envelope exit value – X-coordinate
EN Exit Y	Envelope exit value – Y-coordinate
EN Start X(Y)	Limits of envelope (X-value or Y-value depending on definition)
EN End X(Y)	Limits of envelope (X-value or Y-value depending on definition)

6.3.2.11 External memory

Under "External memory", you can enable/disable data logging on an external USB stick for the current measurement program.

Note: If you wish to log the measurement data on the USB stick, you need to individually enable data logging for each measurement program under "External memory".



This is how it works

- 1 Plug a USB stick into the USB port.
- 2 Enable the "Data logging" checkbox in the "External Memory" tab.

Note: Make sure you use a suitable USB stick. Please refer to the data sheet for further details. The latest version of the data sheet is available at <http://goo.gl/muUe7D>.

When data logging on a USB stick is enabled, a data entry containing results data (but not the measurement curve) is made for each measurement. If you have connected a USB stick to the USB port of the DIGIFORCE[®] 9311, the associated information is displayed in the "Station properties" menu. In this menu, you can set the component name and configure the behavior of the "OUT_READY" control signal.

6.3.3 Channel settings (global)

Note: If you have enabled the "Global channel settings" checkbox in the "Station properties" menu (default setting), a new tab "Channel settings (global)" appears in the menu "Parameterizing DIGIFORCE[®] 9311 – Basic setup". Make all the settings you require in this tab. The "Channel settings" tab under "Measurement programs" is then deactivated.

In the "Station properties" menu, you can define whether you want the channel settings to apply globally to all the measurement programs, or specifically to each measurement program, i.e. set separately for each measurement program. Please note that if the global setting is enabled, then any change will overwrite the settings for all the measurement programs. If you want the settings to be adopted for all the measurement channels, enable the "Global channel settings" checkbox (see section 6.2 "DIGIFORCE[®] 9311 device information (Properties)" on page 41).

IMPORTANT: If you close the menu when "globally" is set, all the previous program-specific channel settings are lost. The settings from the currently set measurement program are then copied to all the other programs.

For further information on channel settings, please see section 6.3.2.1 "Channel settings" on page 55.

6.3.4 Assignment of the PLC in-/outputs

Under "Assignment of the PLC in-/outputs", you can customize which signals appear at certain PLC inputs or outputs. Section 4.3.2 "PLC I/O signals" on page 23 contains a summary of all the signals at the PLC I/O interface.

Note: The assignments made for the configurable PLC inputs/outputs are also relevant when you are handling the corresponding control signals in the real-time process channel via the optional Fieldbus interface.

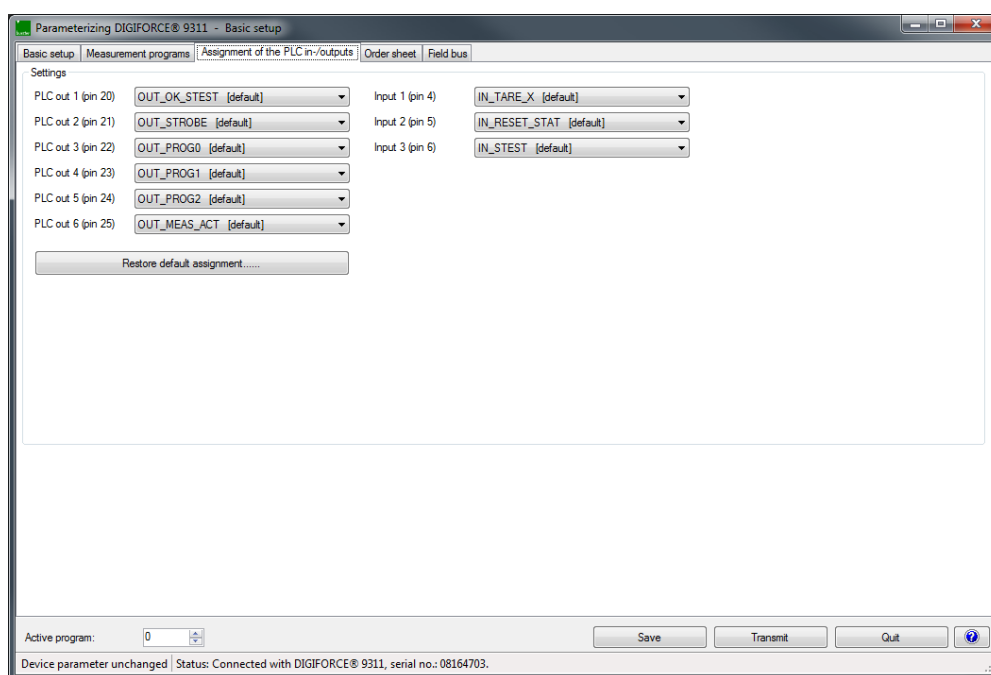

Diagram 60: Assignment of the PLC in-/outputs

6.3.4.1 PLC outputs

Some PLC outputs at the I/O interface or on the optional Fieldbuses can be configured with various functions. Section 4.3.2 "PLC I/O signals" on page 23 contains a full list of the I/O interface assignments including a summary of which pins can be assigned a configurable function.

The following outputs can be configured by the user:

Output	Default assignment	Meaning
Output 1 (Pin 20)	OUT_OK_STEST	Result of sensor test
Output 2 (Pin 21)	OUT_STROBE	Acknowledge signal for measurement program selection
Output 3 (Pin 22)	OUT_PROG0	Bit 0 of echoed measurement program
Output 4 (Pin 23)	OUT_PROG1	Bit 1 of echoed measurement program
Output 5 (Pin 24)	OUT_PROG2	Bit 2 of echoed measurement program
Output 6 (Pin 25)	OUT_MEAS_ACT	Measurement in progress

You can assign the following signals to the outputs:

Signal	Description
OUT_OK_STEST	Sensor test OK
OUT_STROBE	Validity signal for echoed measurement program number
OUT_PROG0	Bit 0 of echoed measurement program number
OUT_PROG1	Bit 1 of echoed measurement program number
OUT_PROG2	Bit 2 of echoed measurement program number
OUT_PROG3	Bit 3 of echoed measurement program number
OUT_MEAS_ACT	Measurement in progress (measurement active)
OUT_S3	Switching signal S3
OUT_S4	Switching signal S4
OUT_S5	Switching signal S5
OUT_S6	Switching signal S6
OUT_TEST_OP	The 9311 is in test mode
OUT_ERROR	Fault / error Possible causes: <ul style="list-style-type: none"> • Measurement started when READY = 0 • Measurement-channel overdrive • Device error during boot-up
OUT_WARN_TARE	Warning that tare limit is reached
OUT_CONFIG	The 9311 is in configuration mode
OUT_ACK_ALARM	Alarm output from Acknowledgement function
OUT_ACK_LOCK	Lock output from Acknowledgement function
OUT_ACK_OK	OK output from Acknowledgement function
OUT_ACK_NOK	NOK output from Acknowledgement function
OUT_PC_LOG	Data logging on PC (DigiControl measurement mode enabled)

Note: You can use the button **[Restore default assignment]** to reset any assignment changes to the factory setting.

6.3.4.2 PLC inputs

Some PLC inputs at the I/O interface or on the optional Fieldbuses can be configured with various functions. Section 4.3.2 “PLC I/O signals” on page 23 contains a full list of the I/O interface assignments including a summary of which pins can be assigned a configurable function.

The following inputs can be configured by the user:

Input	Default assignment	Meaning
Input 1 (Pin 4)	IN_TARE_X	Tare the X-channel
Input 2 (Pin 5)	IN_RES_STAT	Reset the statistics
Input 3 (Pin 6)	IN_STEST	Run the sensor test

You can assign the following signals to the inputs:

Signal	Description
IN_TARE_X	Tare the X-channel
IN_TARE_Y	Tare the Y-channel
IN_TARE_X+Y	Tare the X-channel and Y-channel
IN_RES_STAT	Reset the statistics
IN_STEST	Run the sensor test
IN_TEST_OP	Switch to Graphical test operation (measurement / evaluation without counter)
IN_ACK	Acknowledgement function – acknowledgement of OK and NOK evaluations
IN_ACK_OK	Acknowledgement function – acknowledgement of OK evaluations
IN_ACK_NOK	Acknowledgement function – acknowledgement of NOK evaluations
IN_ACK_ERROR	Acknowledgement of errors/faults (when "OUT_ERROR" = 1)*

*If the DIGIFORCE[®] 9311 has a permanent error, the "OUT_ERROR" output cannot be reset by acknowledging the error.

6.3.5 Order sheet

Under "Order sheet" you can save and retrieve a huge range of background information on the measurement. All entries can be read/written via the available Fieldbus interfaces. The DigiControl PC software can optionally retrieve these entries during automatic logging of measurement data, and use them to create a reference to admin, operator or component in the measurement report file.

- Name of operator
- Order number
- Batch
- Component
- Serial number 1
- Serial number 2

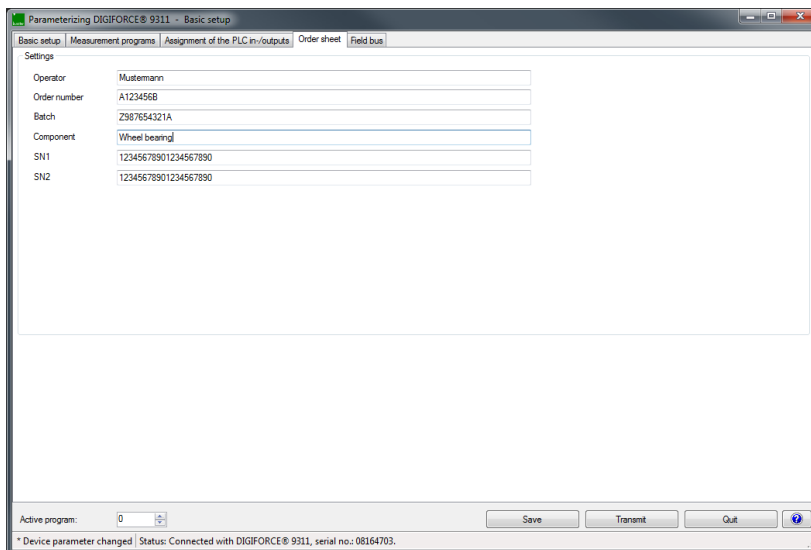

Diagram 61: Order sheet

Note: The order sheet is created globally and not for a specific program, i.e. the same set of data is used whatever the measurement program.

DIGIFORCE® model 9311

Parameters in "Order sheet"

Operator	Name of operator (String [64 characters])
Order number	A123456B (String [64 characters])
Batch	Z987654321A (String [64 characters])
Component	Name of component (String [64 characters])
SN1	Serial number SN1 (String [64 characters])
SN2	Serial number SN2 (String [64 characters])

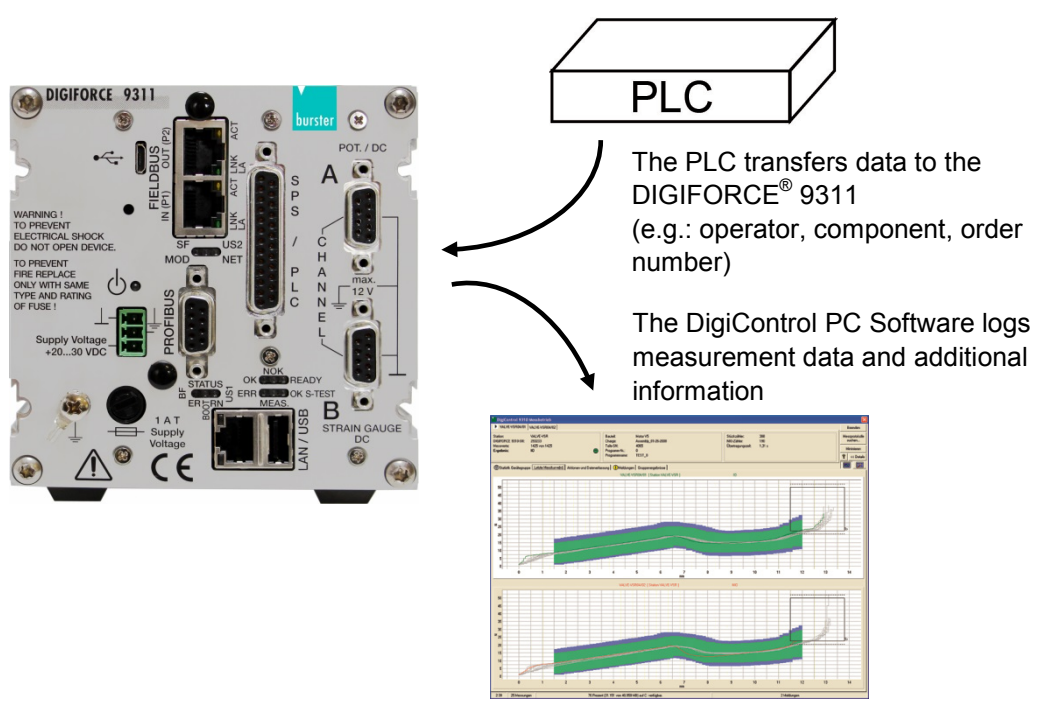

Diagram 62: Order sheet

6.3.6 Fieldbus

The PROFIBUS, PROFINET or EtherNet/IP Fieldbus interfaces are optionally available on the DIGIFORCE® 9311 (see order code in the data sheet).

Note: In the settings for the relevant Fieldbus interface, you can specify in general whether the DIGIFORCE® 9311 responds to control inputs on the PLC I/O interface, which is always available in every DIGIFORCE® 9311 version, or via the control signals on the installed Fieldbus. The output signals, status information and results data are always output irrespective of this setting.

In the "General" tab of the "Station properties" menu, you can find information on the installed Fieldbus hardware (software version, serial number, MAC addresses). If there is an active connection to a PLC master, this tab displays additional information such as the IP parameters.

Diagram 63: Device information for PROFINET Fieldbus variant (no active PLC connection)

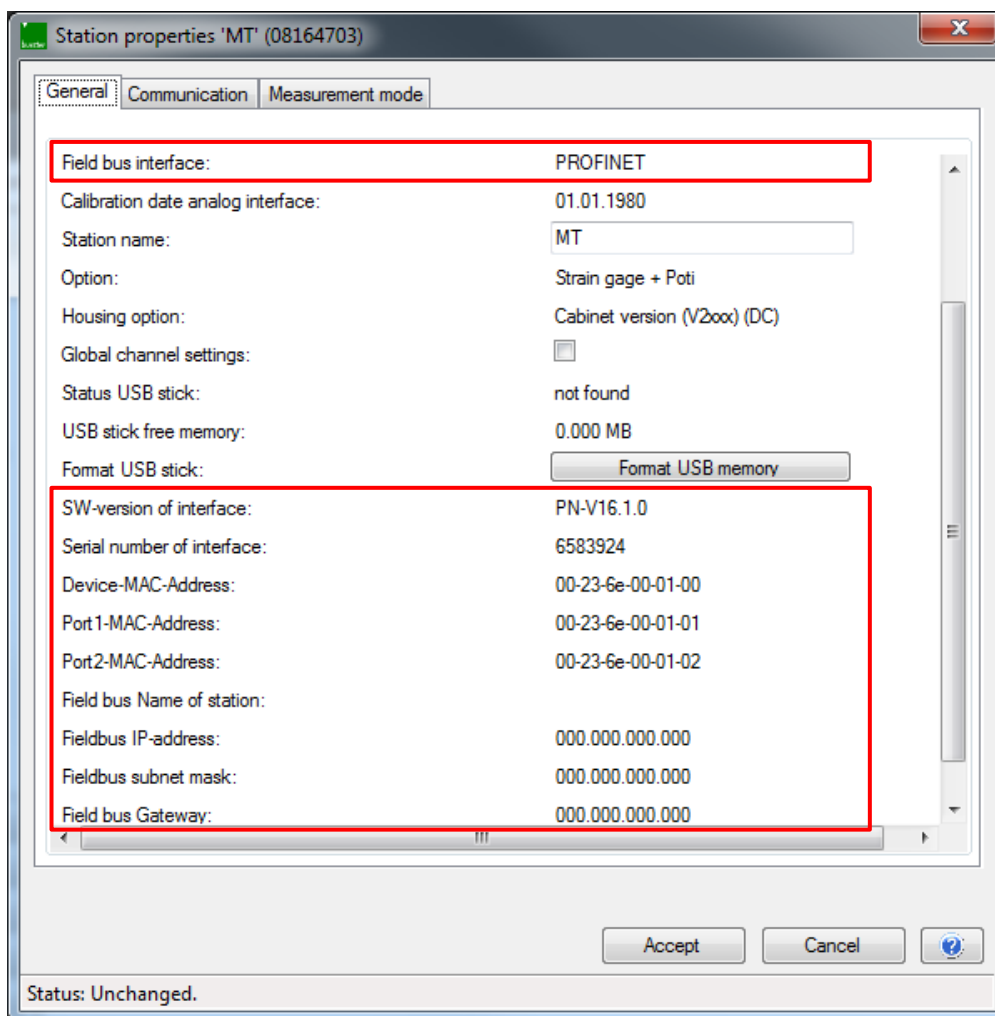

6.3.6.1 PROFIBUS settings (option)

Note: The "PROFIBUS" menu only exists if your DIGIFORCE® 9311 is installed with option Vxxx2.

Configuring the PROFIBUS interface in the "Field bus" tab of the "Parameterizing DIGIFORCE® 9311" menu merely involves specifying the PROFIBUS address and selecting whether the control inputs also respond via the Fieldbus (PROFIBUS) or via the +24 VDC PLC inputs. The output signals, status information and results data are always output irrespective of this setting.

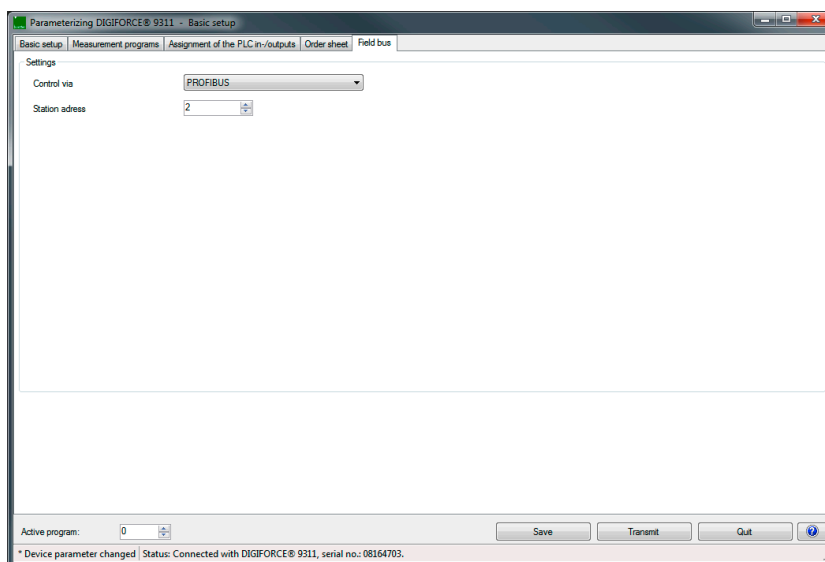

Diagram 64: Field bus – PROFIBUS settings (option)

Parameters in "PROFIBUS"

Control via	<p>PROFIBUS: the DIGIFORCE® 9311 responds solely to control signals (inputs) from the PROFIBUS interface.</p> <p>PLC: the DIGIFORCE® 9311 responds solely to control signals (inputs) from the PLC I/O interface.</p> <p>When control via PLC I/O is selected, data is still transferred using the cyclical PROFIBUS DP-V0 protocol.</p>
Station address	<p>Enter here the PROFIBUS address for the DIGIFORCE® 9311.</p> <p>Valid address range: 1 to 126.</p>

Note: Details of the PROFIBUS interface are provided in a separate document: "The DIGIFORCE® 9311 PROFIBUS manual".

6.3.6.2 PROFINET settings (option)

Note: The "PROFINET" menu only exists if your DIGIFORCE® 9311 is installed with option Vxxx3.

Configuring the PROFINET interface, in the "Field bus" tab of the "Parameterizing DIGIFORCE® 9311" menu merely involves specifying whether the control inputs respond via the Fieldbus (PROFINET) or via the +24 VDC PLC inputs. The output signals, status information and results data are always output irrespective of this setting.

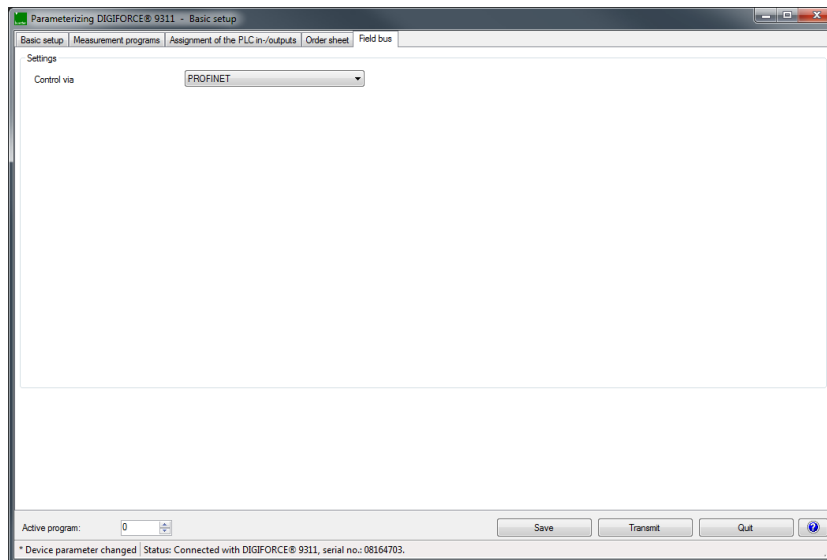

Diagram 65: Field bus – PROFINET settings (option)

Parameters in "PROFINET"

Control via	<p>PROFINET: the DIGIFORCE® 9311 responds solely to control signals (inputs) from the PROFINET interface.</p> <p>PLC: the DIGIFORCE® 9311 responds solely to control signals (inputs) from the PLC I/O interface.</p> <p>When control via PLC I/O is selected, data is still transferred on the PROFINET real-time channel.</p>
--------------------	---

Note: Details of the PROFINET interface are provided in a separate document: "The DIGIFORCE® 9311 PROFINET manual".

Note: If there is an active connection to a PROFINET master, the "Station properties" menu displays additional information such as the PIN IP address, for instance, or the device name assigned by the PLC.

6.3.6.3 EtherNet/IP settings (option)

Note: The "EtherNet/IP" menu only exists if your DIGIFORCE® 9311 is installed with option Vxxx4.

Configuring the EtherNet/IP interface in the "Field bus" tab of the "Parameterizing DIGIFORCE® 9311" menu merely involves specifying whether the control inputs respond via the Fieldbus (EtherNet/IP) or via the +24 VDC PLC inputs. The output signals, status information and results data are always output irrespective of this setting.

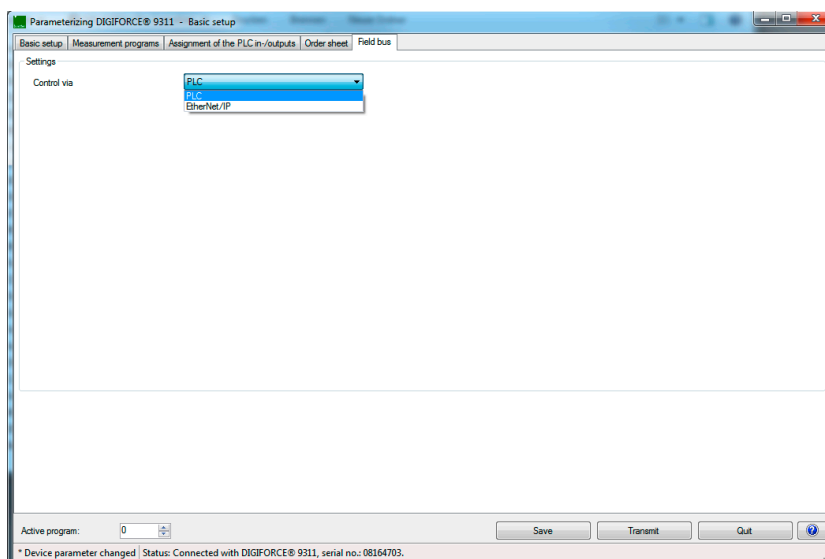

Diagram 66: Field bus – EtherNet/IP settings (option)

Parameters in "EtherNet/IP"

Control via	<p>EtherNet/IP: the DIGIFORCE® 9311 responds solely to control signals (inputs) from the EtherNet/IP interface.</p> <p>PLC: the DIGIFORCE® 9311 responds solely to control signals (inputs) from the PLC I/O interface.</p> <p>When control via PLC I/O is selected, data is still transferred on the EtherNet/IP real-time channel.</p>
--------------------	--

Note: Details of the EtherNet/IP interface are provided in a separate document: "The DIGIFORCE® 9311 EtherNet/IP manual".

Note: If there is an active connection to an EtherNet/IP master, the "Station properties" menu displays additional information such as the EtherNet/IP IP address.

With the DIGIFORCE® 9311 default setting, the EtherNet/IP parameters (IP address, subnet mask and gateway address) can only be assigned by a BOOTP server or DHCP server. Switching to manual assignment (IP configuration = Static) can only be performed by a tool from Rockwell (BOOTP/DHCP server). If you have any questions, please telephone our Service department on +49-7224-645-53, or email: service@burster.com (Germany only). If you are outside Germany, you should contact your burster agent (see also www.burster.com).

7 Numerical test operation and diagnostics

In the "Numerical Test Operation" menu you can retrieve the live sensor values from the active measurement channels X and Y and retrieve the status of the PLC control signals (inputs and outputs). You can also tare each measurement channel separately (the tare function is not available for the optional piezoelectric input).

Note: The tare function may not be possible depending on the channel setting.

You can stimulate the PLC outputs manually in order to test the cable to the connected PLC. The PLC signals can also be viewed/set under Fieldbus communication.

IMPORTANT: Please be aware that stimulating the PLC outputs may cause an unwanted response at the connected controller.

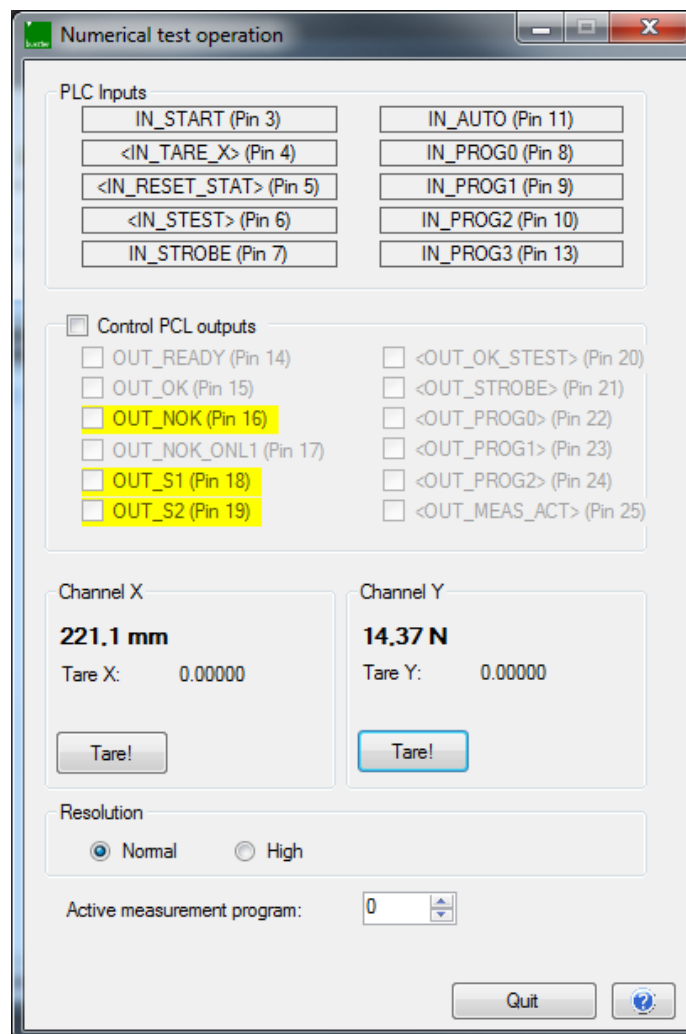

Diagram 67: Numerical test operation

DIGIFORCE® model 9311



This is how it works

- 1 Click on "Measure" > "Numerical test operation".

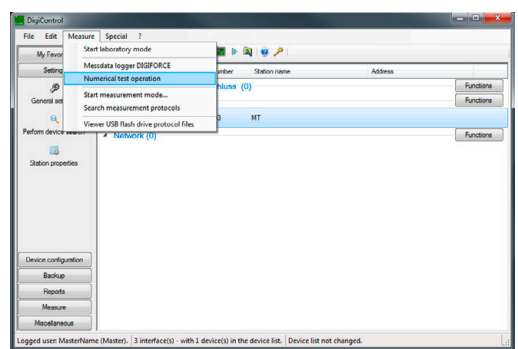

- 2 You are now in the "Numerical test operation" menu.

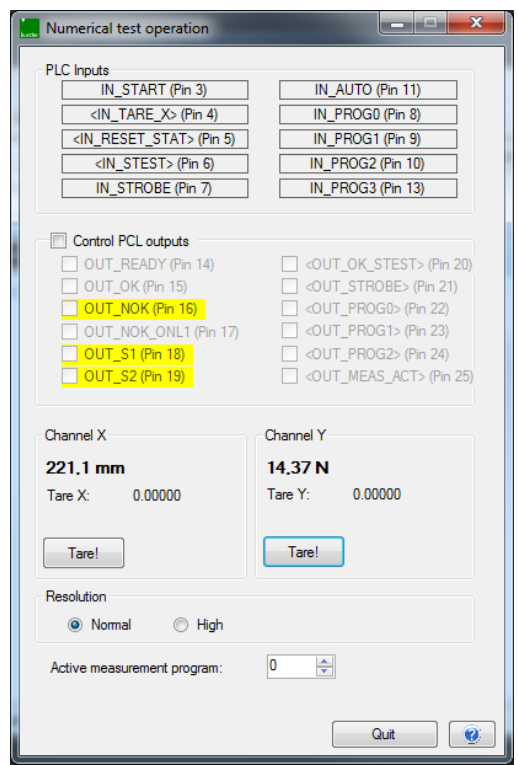

7.1 Numerical test operation – Live sensor values

In the "Numerical test operation", you can view the live sensor values. For analog sensor signals such as strain gage, potentiometer or standard signals, you can set the resolution for the reading to either a four-digit or five-digit display. The resolution can be changed by selecting "Normal resolution" (four-digit display with dynamic decimal point) or "High resolution" (five-digit display with dynamic decimal point).

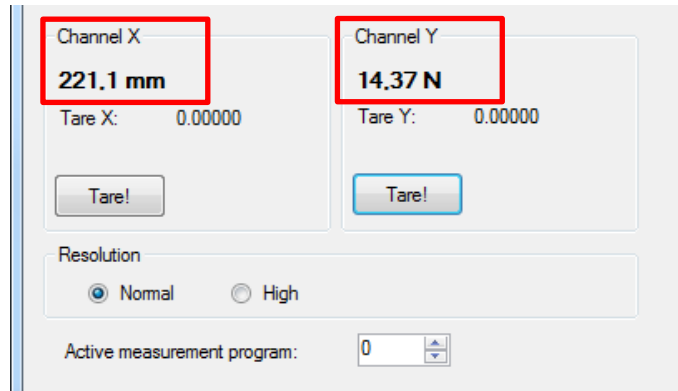

Diagram 68: Live sensor values

Note: The reading is displayed as a floating-point value. The display resolution does not depend on the measurement range. This can give a false impression of the signal quality.

7.2 Numerical test operation - Tare

You can use the **[Tare!]** buttons to tare the live sensor values. Running the tare function will zero the live sensor value or set it to a configurable default value ("Standard value for tare") (for details see the relevant subsection for the individual sensors in section 6.3.2.1 "Channel settings" on page 55). You can also use the PLC control signals "IN_TARE_X", "IN_TARE_Y" and "IN_TARE_X+Y" to run this function in measurement mode.

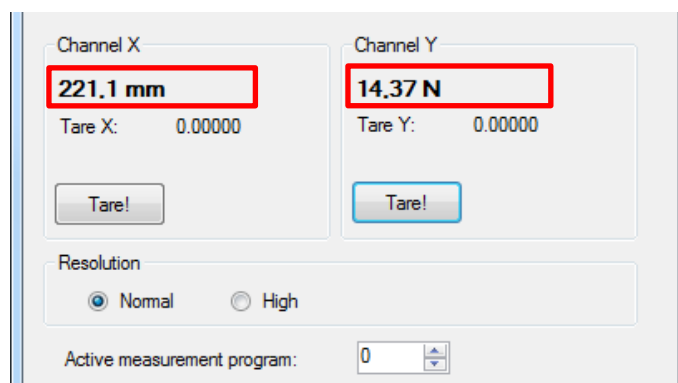

Diagram 69: Numerical test operation - Tare

Note: Clicking **[Tare!]** switches off the tare function again. The tare function will be performed, however, whenever requested by the PLC signals.

7.3 Numerical test operation – PLC signals

You can retrieve the live states of the PLC inputs and outputs in the "Numerical test operation" menu, and also set/reset the PLC outputs. You can also use this function when the DIGIFORCE® 9311 is controlled via the Fieldbus option (e.g. PROFIBUS or PROFINET). In this case, the corresponding signals are displayed and set/reset.

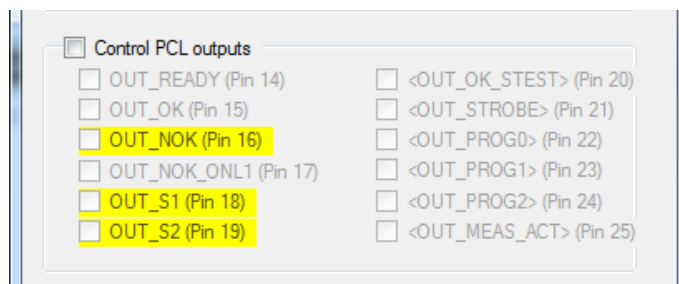

Diagram 70: Numerical test operation – PLC signals

Online switching points

If a measurement exceeds the set limit level then the associated online switching point (S1 to S6) responds in the "Numerical test operation" menu.

If you enable the "Control PLC outputs" checkbox, you can also set and clear the PLC outputs manually, for instance for a connection test. When the menu is closed, the outputs then assume the relevant state again.

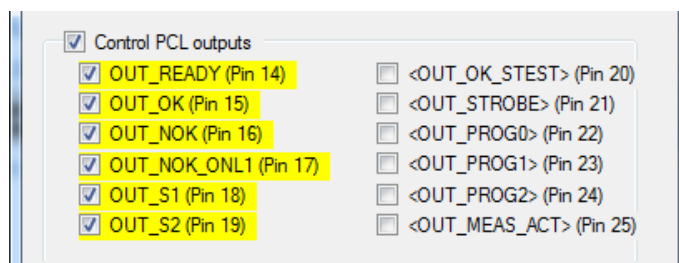

Diagram 71: Numerical test operation – Online switching points

Exception: an online switching point for measurement channel X with trigger reference is enabled solely during a measurement in measurement mode.

You can assign switching signals S3 to S6 to any PLC output eligible for custom signal assignments (please see section 6.3.4.1 "PLC outputs" on page 105).

7.4 Error messages when the unit is powered up

During boot-up, the DIGIFORCE® 9311 may display certain error messages. The DigiControl PC software tests whether a potential hardware fault exists by invoking the following functions:

- Device search
- Open the "Station properties" menu
- Online parameterization
- Laboratory / Measurement mode

The following window is displayed if a fault condition is identified:

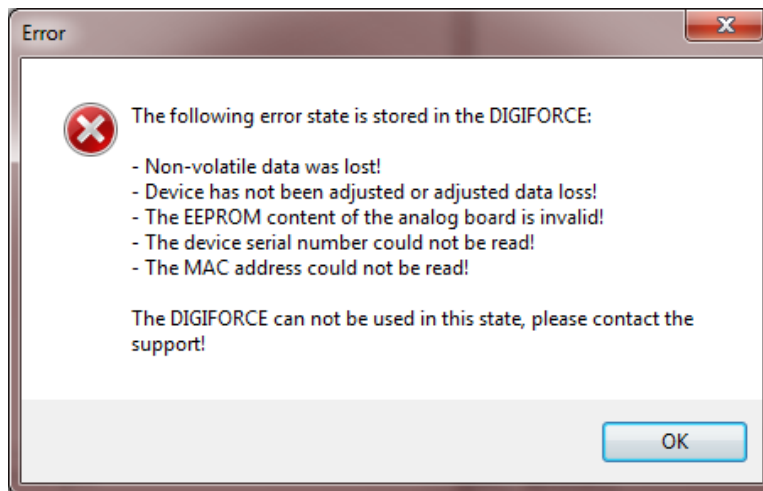

Diagram 72: Error message DIGIFORCE® 9311 (the text may vary)

At the same time, a red exclamation mark appears beside the DIGIFORCE® 9311 in the device list:

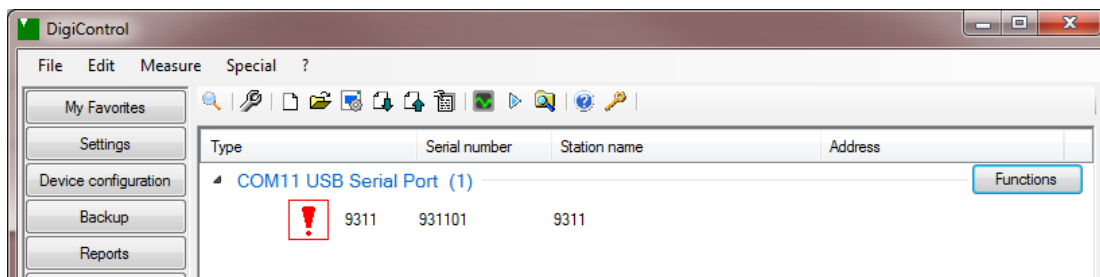

Diagram 73: Device list containing DIGIFORCE® 9311

In any of these cases, please call our Service department on +49-7224-645-53 or email: service@burster.com (Germany only). If you are outside Germany, you should contact your burster agent (see also www.burster.com).

DIGIFORCE® model 9311

7.5 LED status

Note: The LEDs for the Fieldbus interfaces are described in the relevant supplementary documentation (e.g. the DIGIFORCE® 9311 PROFINET manual).

LED	Description
Red "ERR" LED (Error) is On even during power-up	There is a device error (see section 7.4 "Error messages when the unit is powered up" on page 118)
"NOK" and "ERR" show a steady light (reduced intensity, remaining LEDs are off)	Ready for software update The concealed Reset button below the USB port was pressed during power-up. An update can be performed using the DigiControl PC software (10.8 Firmware update on page 158)
"OK", "NOK", "READY", "ERR", "MEAS.", "OK S-TEST" are illuminated after power-up for about 5 s	In this phase you can set the Ethernet interface configuration to default values by pressing the concealed button. The standard application in the DIGIFORCE® 9311 booted up successfully and has switched into normal operation

Note: In normal operation, the "ERR" LED (Error) indicates various error events (group signal) (see also section 4.1 "Status LED (normal operation)" on page 21).

7.6 LOG file from the DIGIFORCE® 9311

The DIGIFORCE® 9311 stores various events, faults and errors in a LOG memory. Up to 256 entries are held in a FIFO memory, in which repetitions are totted up. You can open this LOG memory in the DigiControl PC software using "?" > "Service" > "Logfile DIGIFORCE".

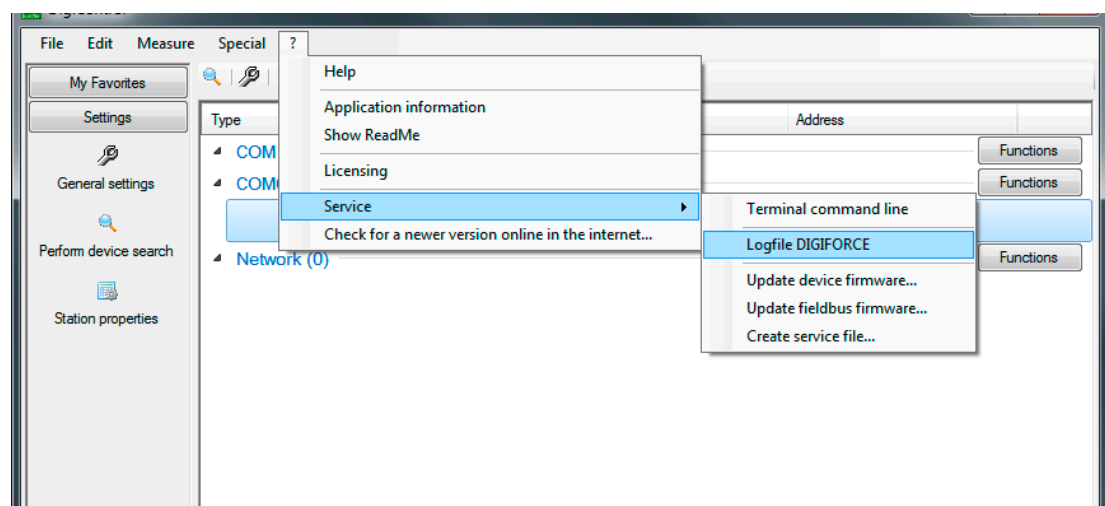

Diagram 74: DIGIFORCE® 9311 logfile

The log entries help you to analyze the cause of possible faults or errors more effectively. Examples of frequent causes are:

Measurement without READY

A measurement was started without the equipment being ready (READY = 0). This can interrupt the DigiControl PC software performing automatic measurement data acquisition for instance, and then the log is incomplete. Only start a measurement in the status READY = 1.

Measurement-channel overdrive

One of the two measurement channels is continuously overdriven, or was overdriven during the measurement. This may be caused by a defect in the sensor connecting lead or directly at the sensor. Check the sensor signal in "Numerical test operation" (see section 7.1 "Numerical test operation – Live sensor values" on page 116). Continuous overdrive will be indicated by <OVR> (over-range) in Numerical test operation (see section 7.3 "Numerical test operation – PLC signals" on page 117).

Reading the log file



This is how it works

- 1 Select the DIGIFORCE® 9311 in the device list.
- 2 Click on "?" > "Service" > "Logfile DIGIFORCE".

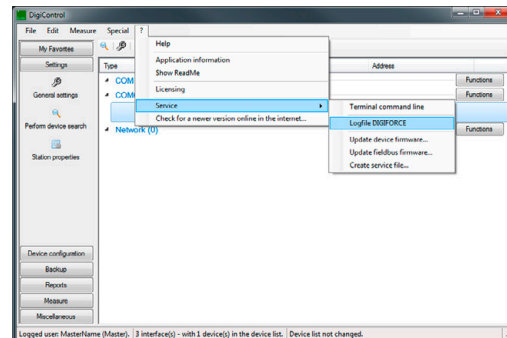

- 3 Click **[Read out]** to transfer any log entries present. You can sort the log entries by clicking on the column header. We recommend sorting by "Date/Time" to list the most recent log entries at the top.

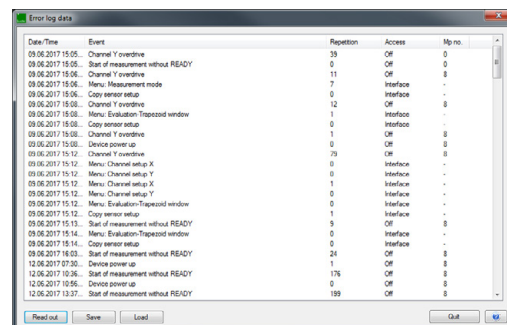

- 4 Click **[Quit]** to close the error log data.

8 Retrieving measurement curves and measurement results

8.1.1 Laboratory mode

The base version of the DigiControl analysis and configuration software supplied with the DIGIFORCE® 9311 cabinet module supports manual retrieval of measurement curves in "Laboratory mode". Automated retrieval of measurement data, for instance to log data obtained from all the parts in a production process, is only supported by the Plus version, DigiControl 9311-P100.

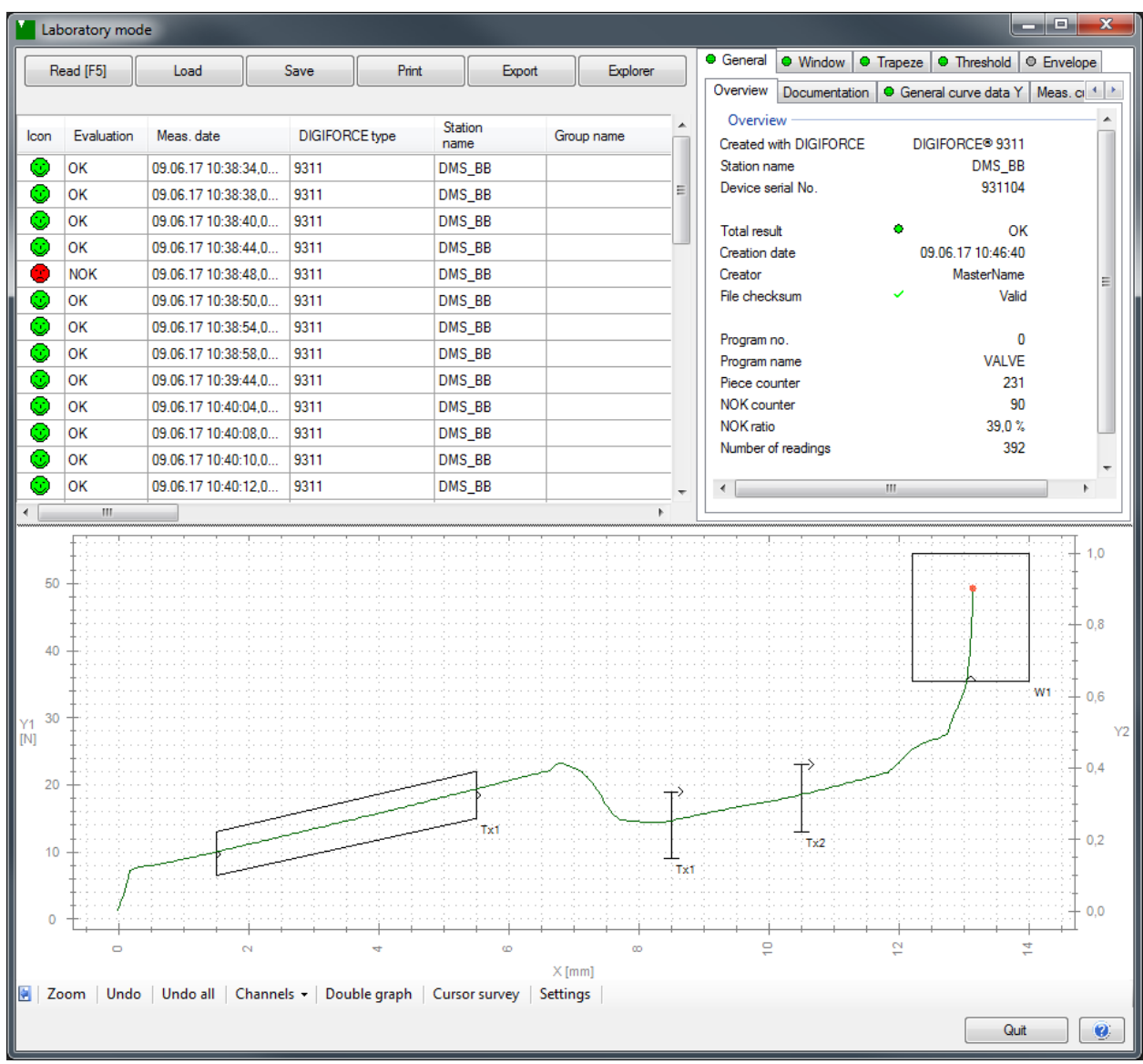

Diagram 75: Laboratory mode

In "Laboratory mode" you can retrieve the measurement currently held in the DIGIFORCE® 9311, and also display, analyze, save as a log file (format *.meas9311) and print this measurement as well as perform a data export as an Excel or ASCII plain-text file (*.csv). Saved log files can later be re-loaded or alternatively opened and viewed using the function "Find and edit measurement curves".



This is how it works

- 1 Select the DIGIFORCE® 9311 in the device list.
- 2 Click on "Measure" > "Start laboratory mode".

Note: You must first select the DIGIFORCE® 9311 in the device list before you can select "Start laboratory mode".

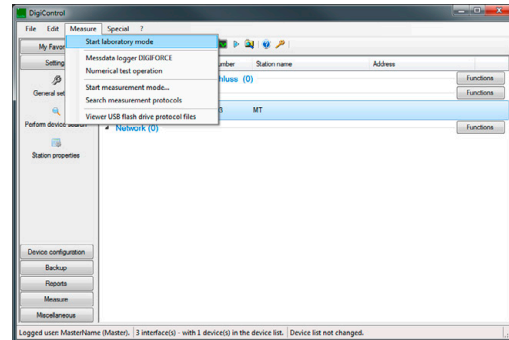

- 3 You are in the "Laboratory mode" menu.

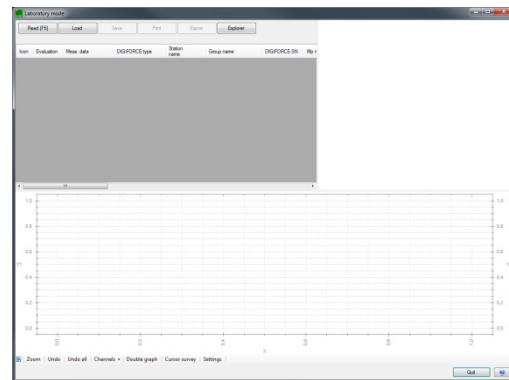

- 4 Alternatively, you can also open laboratory mode by clicking on "Start laboratory mode" in the side bar or clicking the Laboratory mode icon.

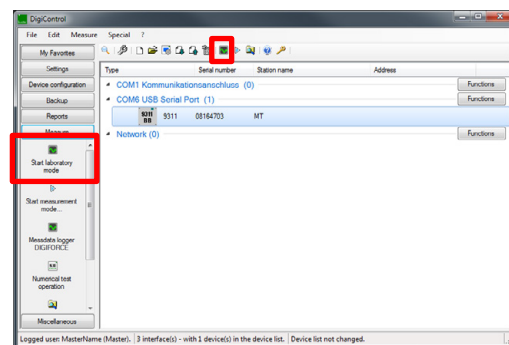

DIGIFORCE[®] model 9311

8.1.1.1 Configuring laboratory mode

Retrieving measurement data



This is how it works

- 1 Click on **[Read [F5]]**.

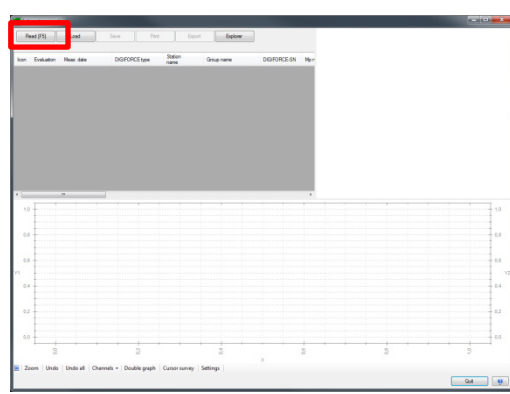

- 2 The measurement data from the last measurement is displayed. If the DIGIFORCE[®] 9311 does not contain any measurement data, a message to this effect is displayed.

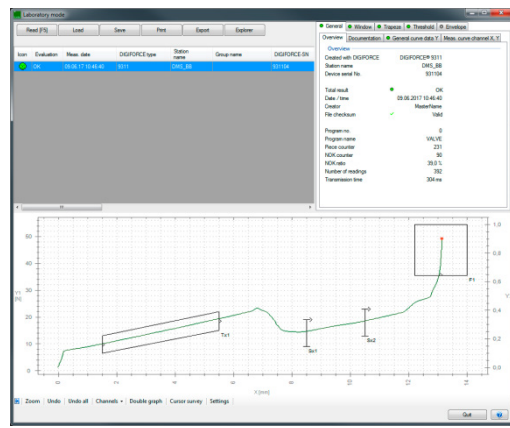

Save

The displayed measurement data can also be saved in a special format that can be read by the DigiControl PC software.



This is how it works

- 1 Click on **[Save]**.

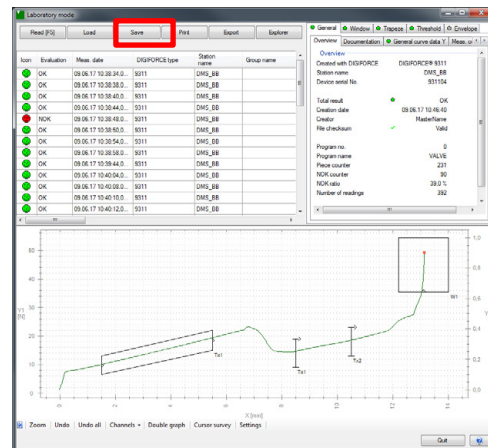

- 2 Enter the parameters you require and click **[OK]**.

Note: When saving measurement data, a digital signature is created that can be used to indicate if the file has been tampered with. You can specify the default destination directory for the measurement data in the General Settings (Data storage).

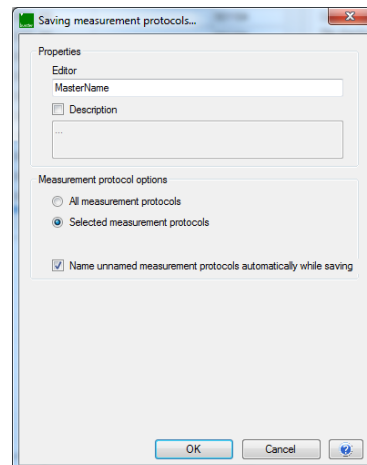

DIGIFORCE® model 9311

Load

Measurement data previously saved using **[Save]** can be re-displayed in the Laboratory mode window using **[Load]**. You can specify the default destination directory for the measurement data in the General Settings (Data storage).



This is how it works

- 1 Click on **[Load]**.

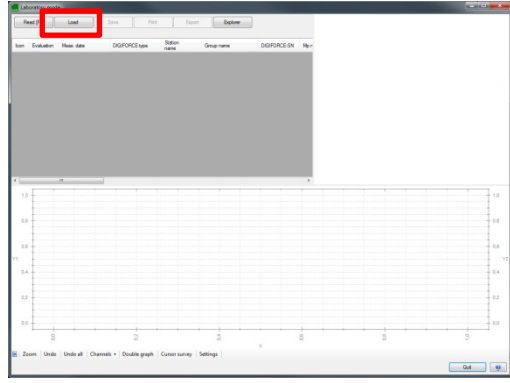

- 2 Select from the directory the previously saved measurement data that you require, then click **[Open]**.

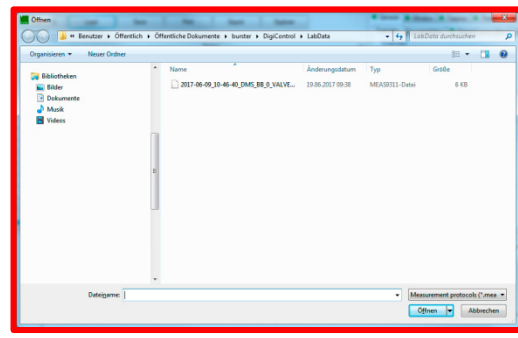

Print



This is how it works

- 1 Click on **[Print]**.

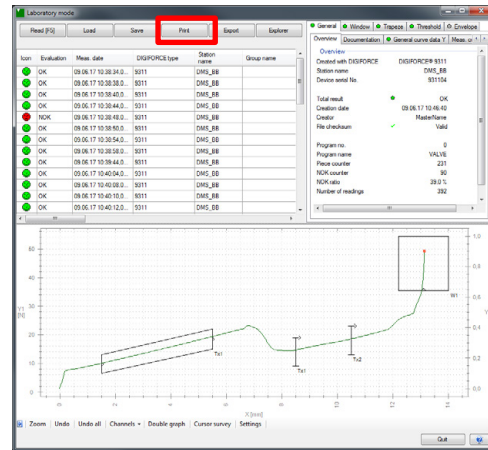

- 2 Enter the parameters you require and click **[OK]**.

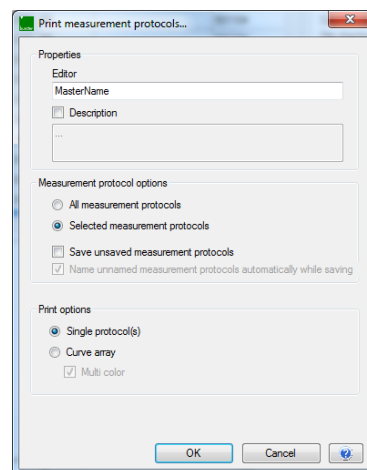

- 3 Select the print options you require and click **[Start]**.

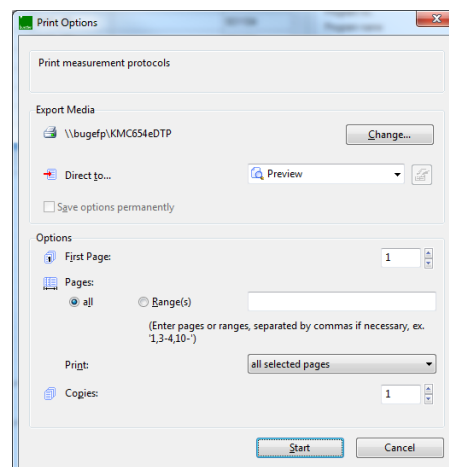

DIGIFORCE® model 9311

Export

You can export the measurement data transferred from the DIGIFORCE® 9311 into an Excel or ASCII plain-text file (csv), for instance.



This is how it works

- 1 Click on **[Export]**.

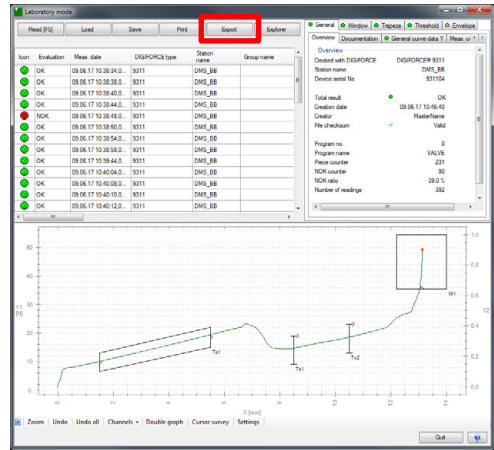

- 2 Enter the parameters you require and click **[OK]**.

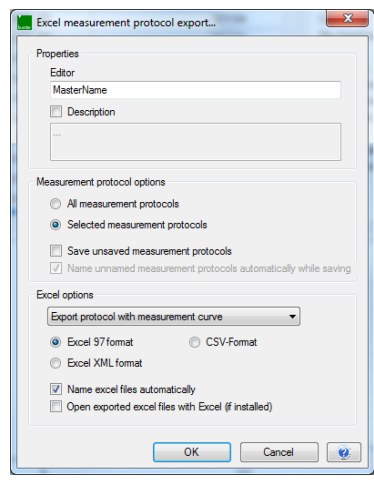

Evaluation

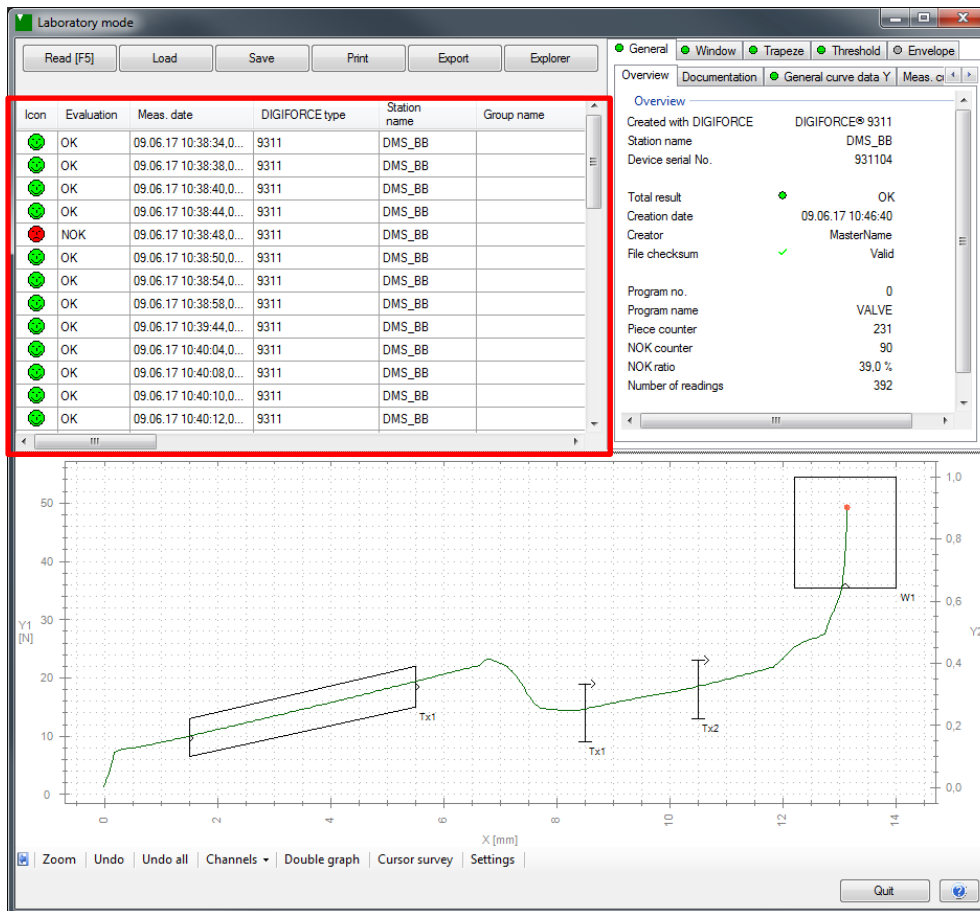

Diagram 76: Laboratory mode - Evaluation

Once the measurement data has been retrieved from the DIGIFORCE® 9311, you are given a huge range of information about the individual measurement curves and their evaluation.

The following information is available:

- Icon (evaluation as smiley)
- Evaluation (OK/NOK)
- Measurement date
- DIGIFORCE® type
- Station name
- Group name
- DIGIFORCE® serial number
- Measurement program name
- Measurement program number
- Values
- Component
- Batch
- Part number
- Remark
- Piece counter
- Measurement depth
- File path

Apart from the evaluation icon and the (OK/NOK) result, the corresponding measurement curve is also colored in green for OK and red for NOK.

8.1.1.2 Displaying the measurement data

General - Overview

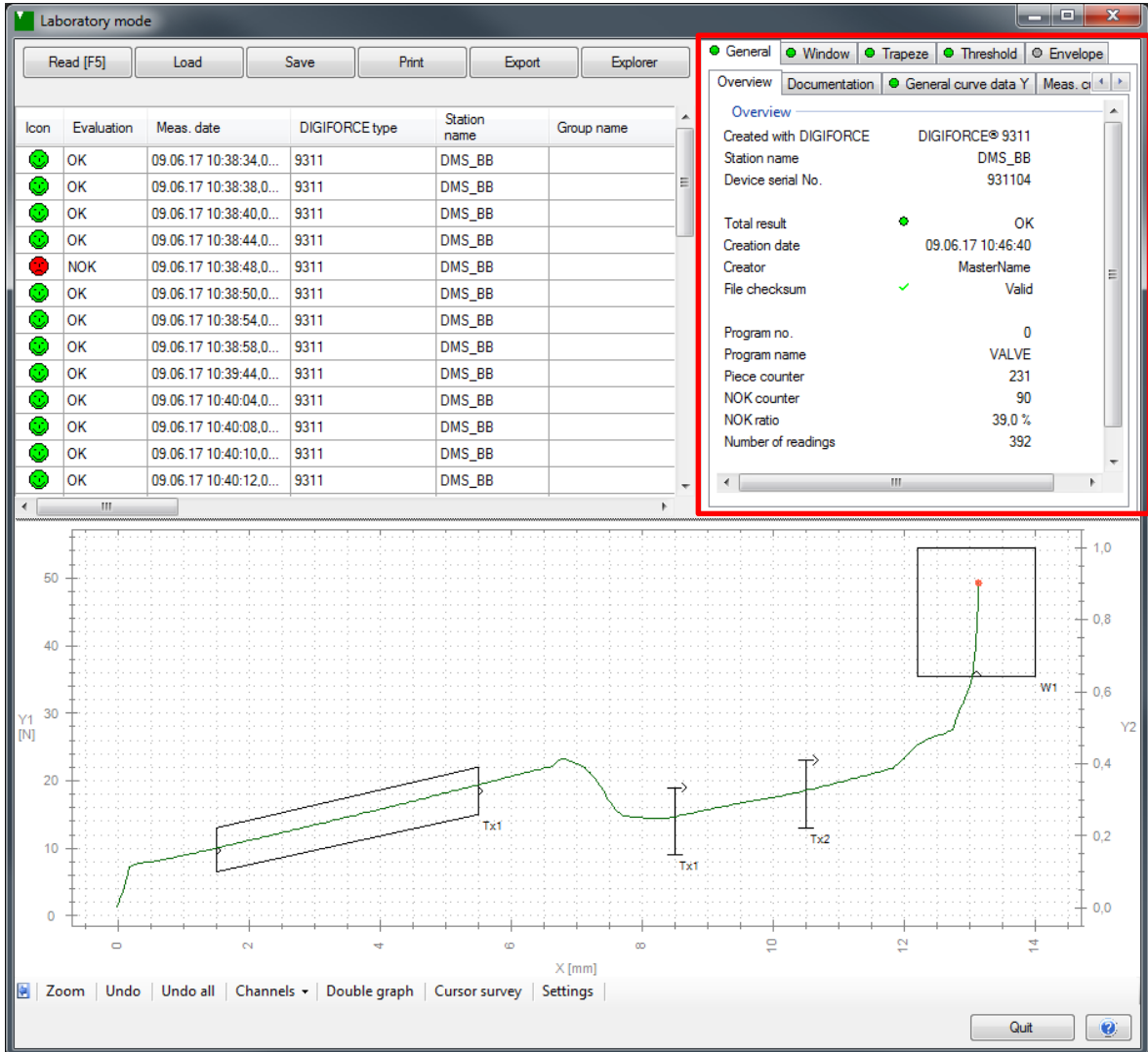

Diagram 77: Laboratory mode – Overview

In the "Overview" tab you can view the following information on the latest measurement data:

- DIGIFORCE® type
- Station name
- Device serial number
- Total result
- Creation date
- Creator
- File checksum
- Program number
- Program name
- Piece counter
- NOK counter
- NOK ratio
- Number of readings

General curve data Y

In the "General curve data" tab you can view the following curve data (X/Y coordinates) for the latest measurement data:

- Xmin
- Xmax
- Ymin
- Ymax
- Start
- Final
- Return

Measurement curve channel X, Y

In the "Measurement curve channel X, Y" tab, you can view the respective measured-value pairs according to the sampling rate of the selected measurement curve.

To display a measured-value pair in the graph, select this pair in the "Measurement curve channel X, Y" tab.

Note: A selected measured-value pair is indicated with a red marker in the graph. You can use the keyboard cursor to traverse the measurement curve. The red marker helps you to get a quick and accurate impression of the course of the measurement curve, and in the event of an NOK evaluation, to analyze the cause of the evaluation result (e.g. repeated entry/exit across a window boundary).

Window

If the "Window" evaluation element is enabled for the selected measurement (at least one window), you can see the results and parameter settings in the "Window" tab.

Trapezoid

If the "Trapezoid window" evaluation element is enabled for the selected measurement (at least one trapezoid window), you can see the results and parameter settings in the "Trapezoid" tab.

Threshold

If the "Threshold" evaluation element is enabled for the selected measurement (at least one threshold), you can see the results and parameter settings in the "Threshold" tab.

Envelope

If the "Envelope" evaluation element is enabled for the selected measurement, you can see the results and parameter settings in the "Envelope" tab.

DIGIFORCE® model 9311

8.1.1.3 Graph

Configuring the graph

Please refer to the Online Help of the DigiControl PC software for details on how to configure the graph. You can open the Online Help facility from any menu via this icon

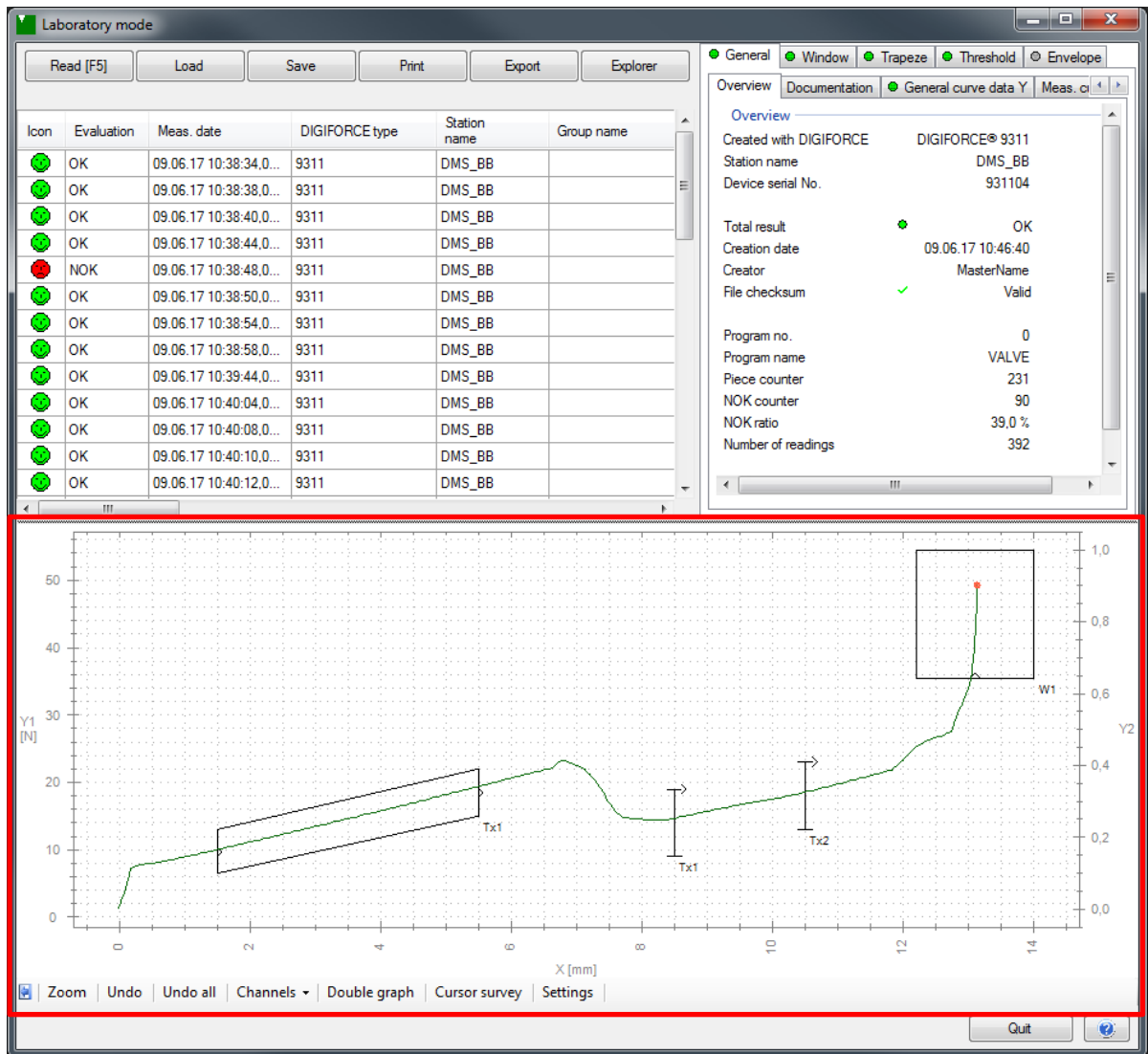

Diagram 78: Laboratory mode – Graph

8.1.2 Reading the data logger

The "Measurement data logger" function lets you retrieve up to 50 most recent measurements performed in the DIGIFORCE® 9311. You can display and analyze the measurement curves individually or as a curve array (set of curves). In addition, you can save the measurements as a log file (format *.meas9311), print the measurements and export them in a data export to an Excel or ASCII plain-text file (*.csv). Saved log files can later be re-loaded or alternatively opened and viewed using the function "Find and edit measurement curves".

Note: The last 50 measurements from the data logger do not contain all the parameters from the laboratory mode.

IMPORTANT: Please note that the measurement curves are stored in volatile memory in the DIGIFORCE® 9311, i.e. the data is lost when the unit is powered down.

The following information is available:

- Icon (evaluation as smiley)
- Evaluation (OK/NOK)
- Measurement date
- DIGIFORCE® type
- Station name
- DIGIFORCE® serial number
- Measurement program name
- Measurement program number
- Values
- Piece counter
- Measurement depth
- Channel limitation

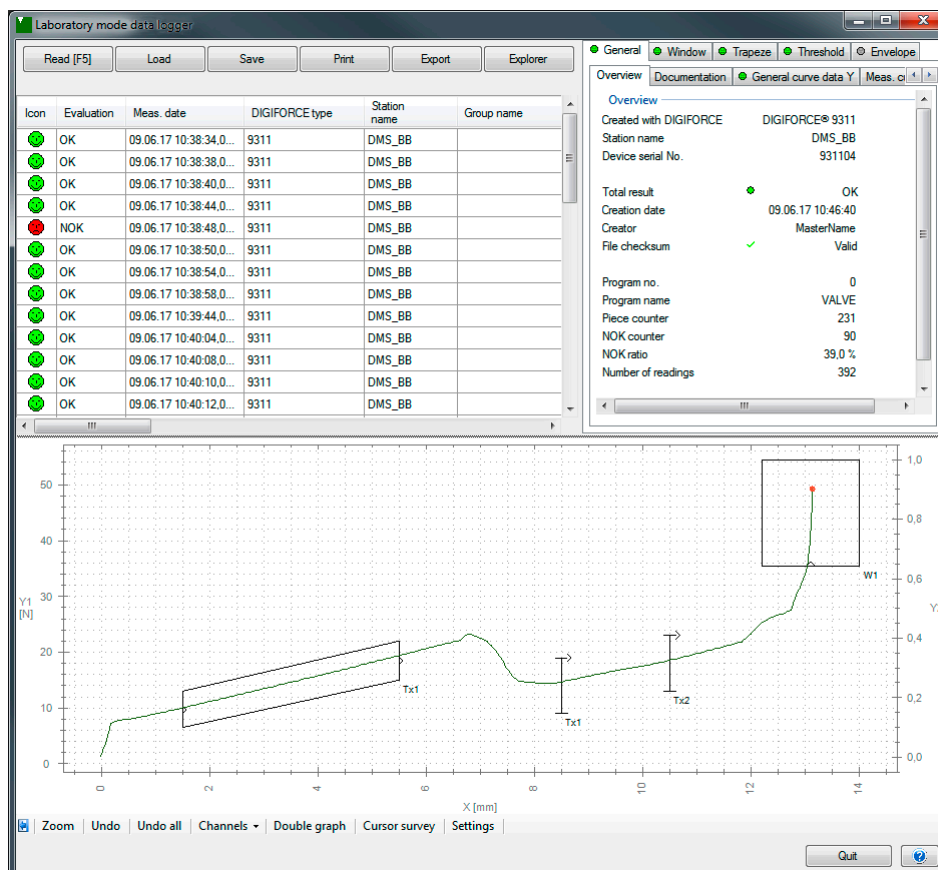

Diagram 79: Laboratory mode data logger

DIGIFORCE® model 9311

Retrieving measurement data



This is how it works

- 1 Click on **[Read [F5]]**.

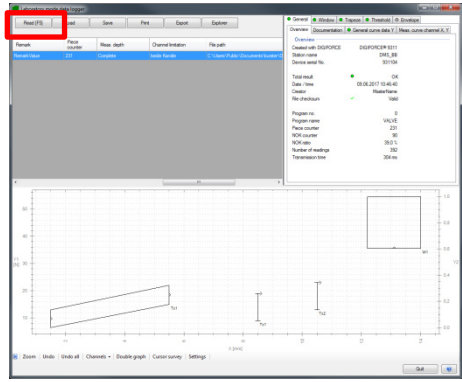

- 2 The measurement data from the most recent measurements is displayed (max. 50). If the DIGIFORCE® 9311 does not contain any measurement data, a message to this effect is displayed.

Note: Please note that the measurement curves are stored in volatile memory in the DIGIFORCE® 9311, i.e. the data is lost when the unit is powered down.

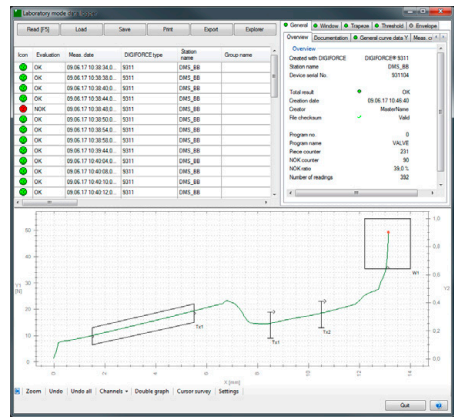

For further details on the "Laboratory mode data logger", please refer to section 8.1.1.1 "Configuring laboratory mode" on page 123.

8.1.3 Measurement mode DigiControl

The "Measurement mode" function allows automatic and rapid measurement data logging from one or more DIGIFORCE® controllers.

Note: The "Measurement mode" function is only supported in the licensed PLUS version 9311-P100 of the DigiControl PC software.

Under "Station properties", you can specify what to include in the data acquisition and logging and save custom documentation parameters such as component and batch name, for instance. Some of these documentation parameters can also be entered by automated transfer, for instance via the DIGIFORCE® Fieldbus interfaces or via the DigiControl Remote interface (please refer to the relevant supplementary documentation on the Fieldbus interfaces and the DigiControl Remote interface).

Note: The path for the data logging file and/or the configuration for the database export can be set in the "Data storage" tab under the DigiControl "General settings".

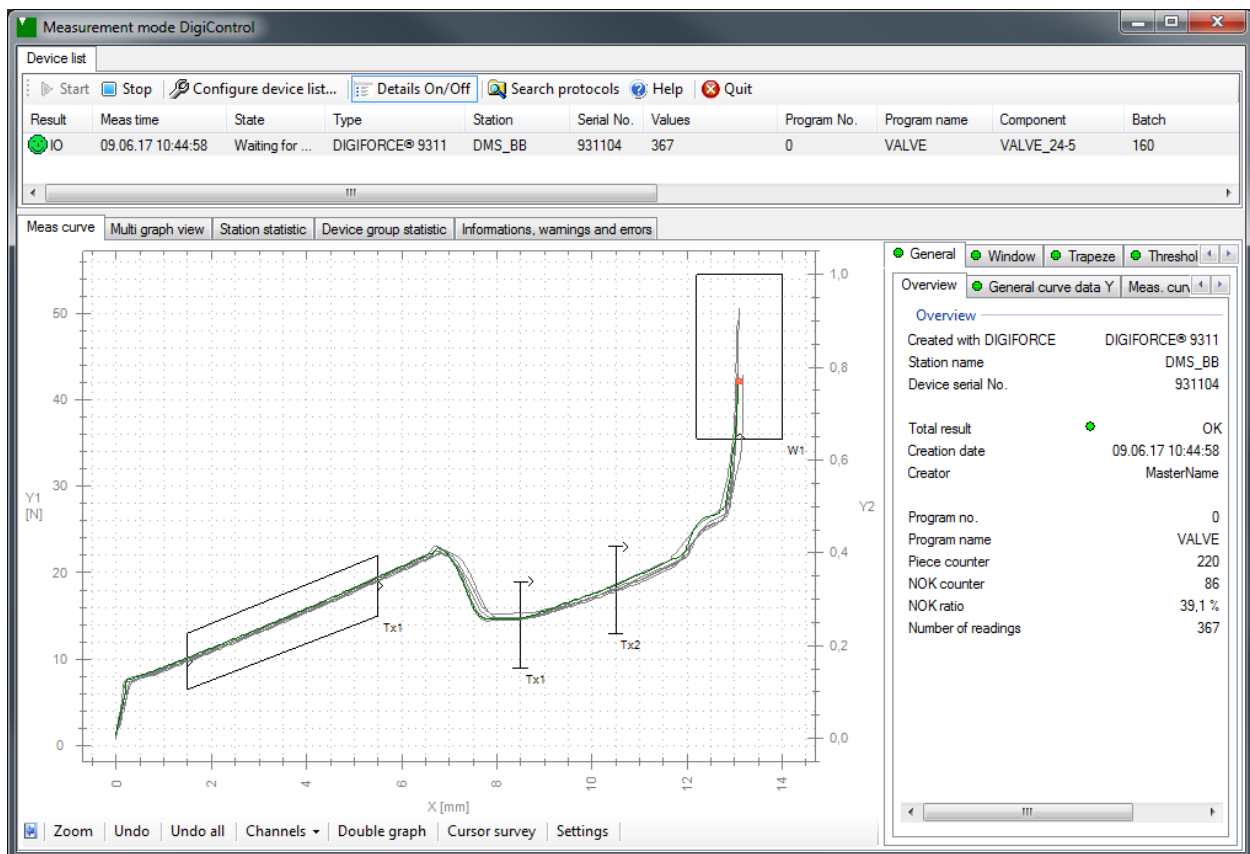

Diagram 80: Measurement mode DigiControl

8.1.3.1 General settings – Measurement mode

Under the "Measurement mode" tab in the General settings, you can define a number of preferences for the measurement mode function. For instance you can choose to display a set of curves for the most recent measurements and also create a Windows startup shortcut for measurement mode. Further details of this dialog window can be found in the Online Help of the DigiControl PC software opened from this tab. Click on to open the Online Help.

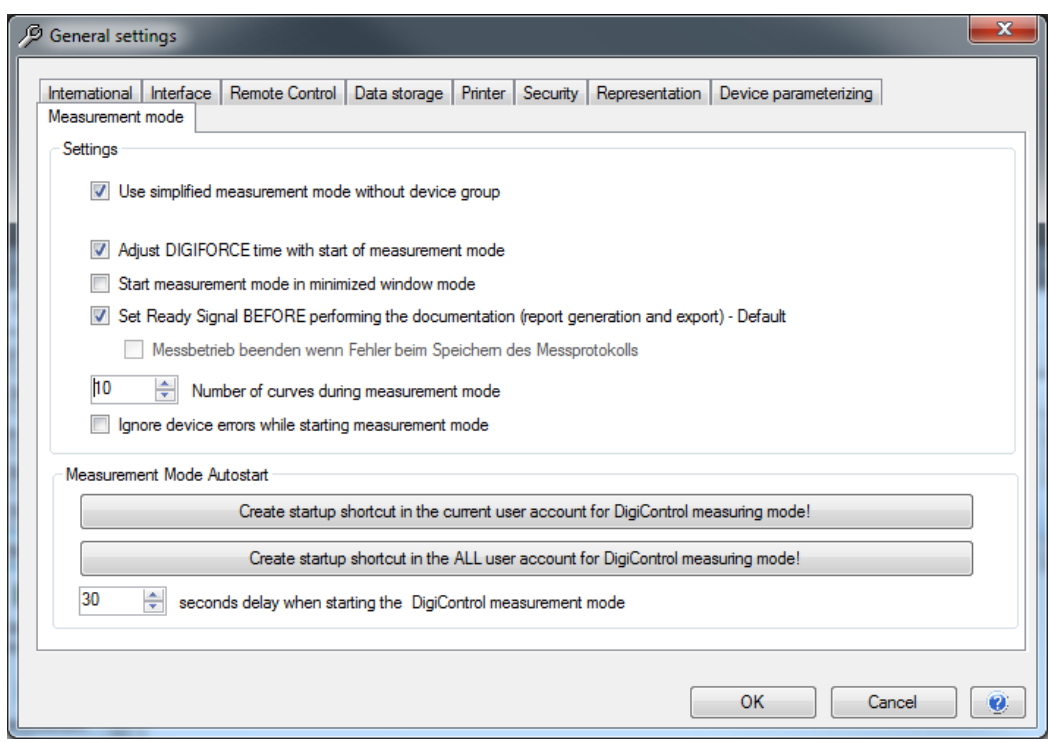

Diagram 81: DigiControl General settings "Measurement mode"

8.1.3.2 Data logging contents and documentation parameters for measurement mode

In the "Station properties" menu, you can make settings for each DIGIFORCE® controller, including (under the "Data logging" tab) what data is logged and in what format, custom documentation parameters such as component name, batch ID and serial numbers and also administrative values.

Note: Documentation parameters such as component serial number or data matrix code can also be entered by automated transfer to the DIGIFORCE® controller via the Fieldbus interface or alternatively via the Remote interface (please refer to separate interface manuals on the Fieldbus interfaces and the DigiControl Remote interface).

You specify the data logging contents in the "Data logging" tab. The default setting is to produce a log file only in the burster-specific format *.meas9311. This file can only be interpreted by the DigiControl PC software.

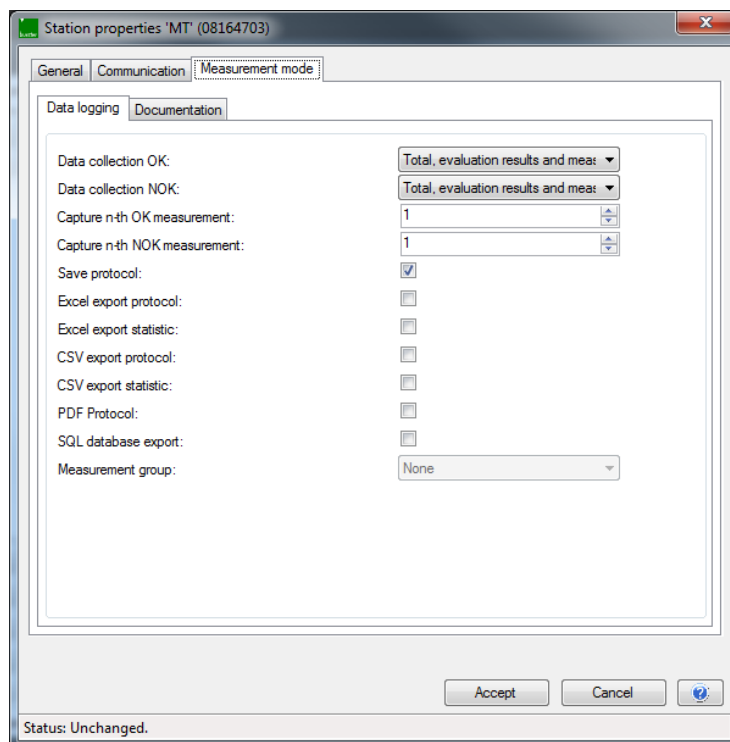

Diagram 82: "Station properties" menu, "Measurement mode" tab (only with PLUS version)

The following formats are also available to you:

- Excel for curve export
- CSV for curve export
- Excel for statistics export
- PDF for log printout
- SQL export (stored procedure; see additional documentation)

Note: The path for the data logging file and/or the configuration for the database export can be set in the "Data storage" tab under the DigiControl General settings.

DIGIFORCE® model 9311

8.1.3.3 Starting measurement mode

You can start measurement mode manually via "Measure" > "Start measurement mode ..." or via the Quick Launch bar on the left-hand side. Another option is to use a startup shortcut or launch a startup process via the DigiControl Remote interface.

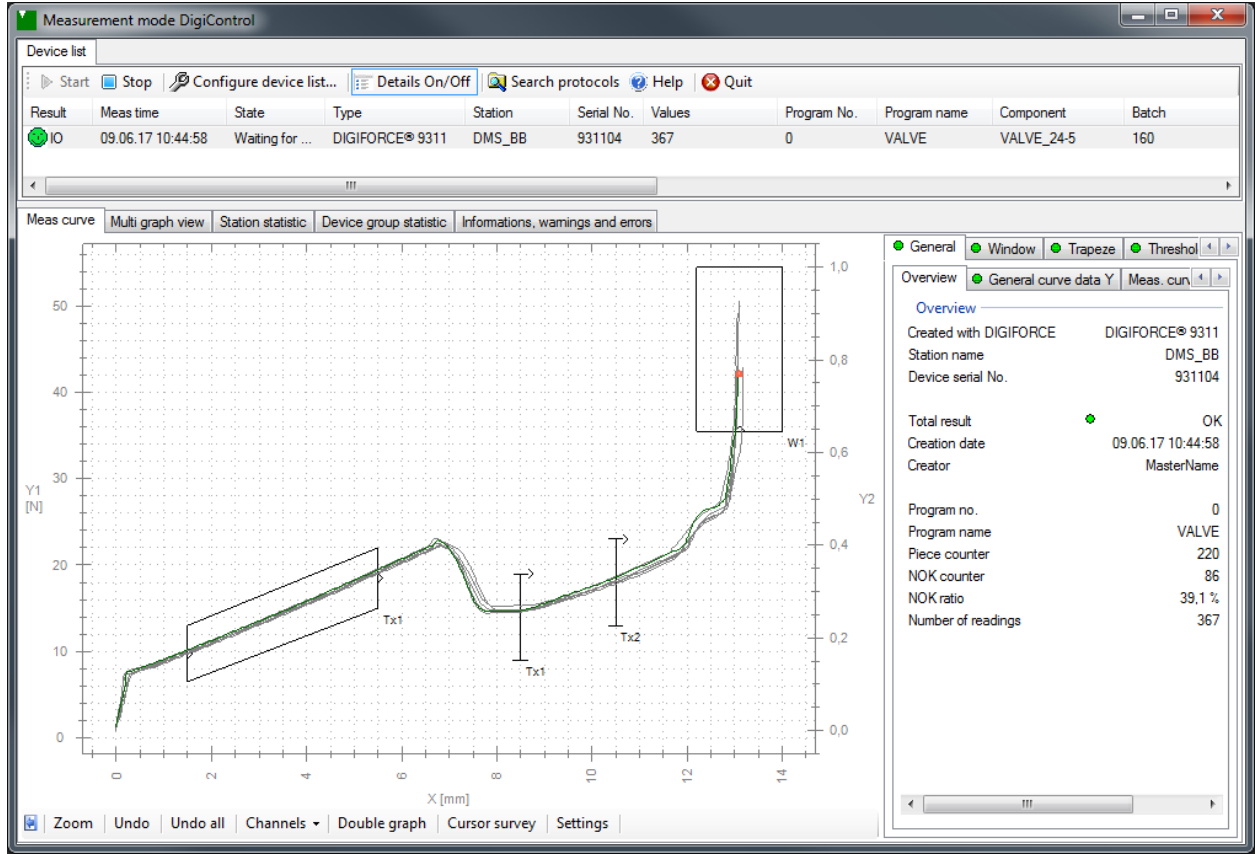

Diagram 83: Measurement mode DigiControl

The Status bar at the top ("Device list") displays the DIGIFORCE® controllers that are currently included in the measurement mode. You can use the "Configure device list ..." function to add or remove DIGIFORCE® controllers that appear in this list. When using more than one DIGIFORCE® controller, you can switch the curve view underneath into a view showing up to 8 channels at once ("Multi graph"), so that you can gain a quick and convenient overview covering several processes. To the right of the graph, the "Meas curve" view also displays detailed results from the measurement.

Note: The READY control signal at the DIGIFORCE® controller is timed with a delay when data logging is active (measurement mode running) (please also see section 10.2.2 "Measurement with measurement-data logging" on page 145).



This is how it works

- 1 Click on "Measure" > "Start measurement mode ...".

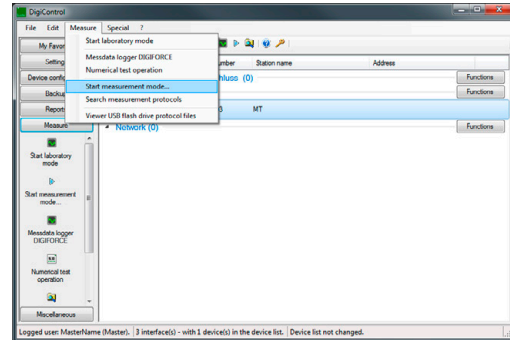

- 2 Perform one or more measurements. The measurements are displayed for you. Click on **[Stop]** to stop recording the measurements, and on **[Start]** to record measurements.

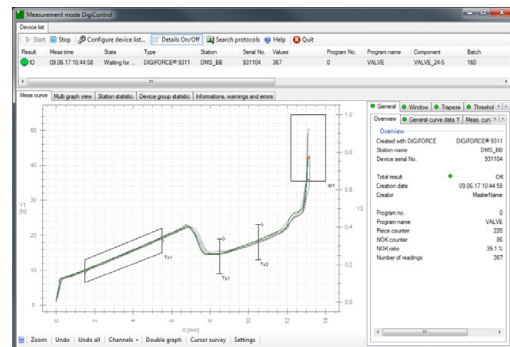

9 Data backup

You can use the DigiControl PC software to perform a backup of your settings and the device parameters in the DIGIFORCE® 9311, or to overwrite existing settings and device parameters with data from a backup.

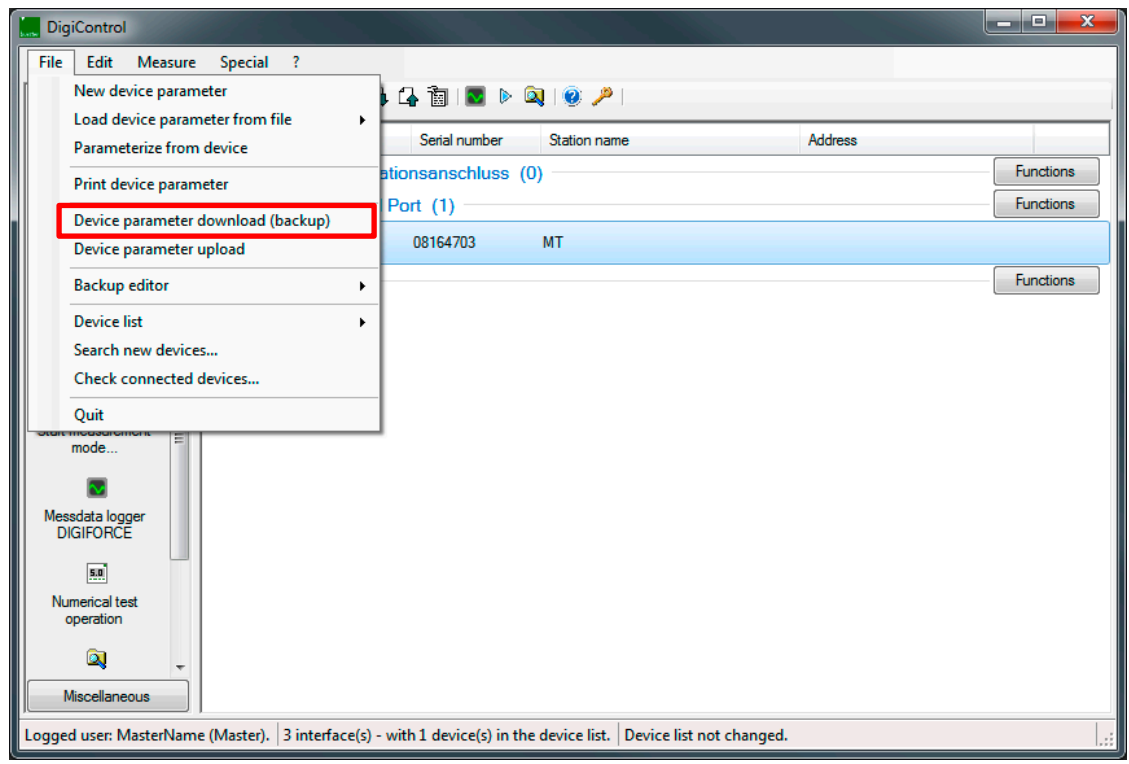

Diagram 84: Downloading (creating) and uploading a data backup

9.1 Creating a data backup – Download



This is how it works

- 1 Select the DIGIFORCE® 9311 in the device list.
- 2 Click on "File" > "Device parameter download (Backup)".

Note: You must first select the DIGIFORCE® 9311 in the device list before you can select "Device parameter download (Backup)".

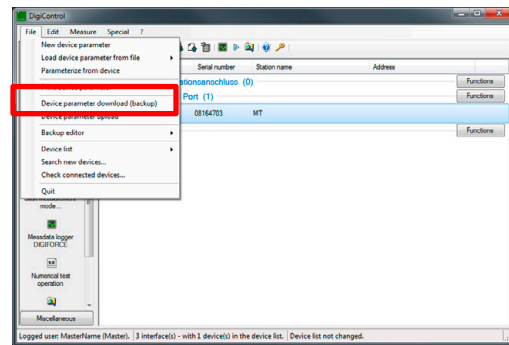

- 3 Click on [Yes].

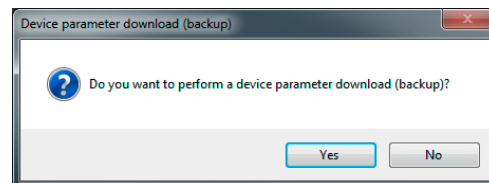

- 4 The device parameters are read from the DIGIFORCE® 9311 and downloaded.

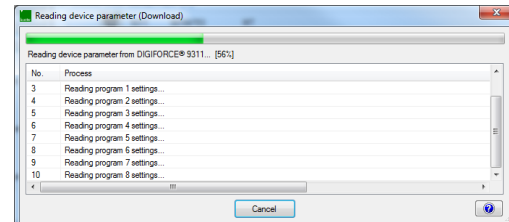

- 5 Select where you want to save the backup and click [Save].

DIGIFORCE® model 9311

9.2 Writing a data backup to the DIGIFORCE® 9311 - Upload

 This is how it works

- 1 Select the DIGIFORCE® 9311 in the device list.
- 2 Click on "File" > "Device parameter upload".

Note: You must first select the DIGIFORCE® 9311 in the device list before you can select "Device parameter upload".

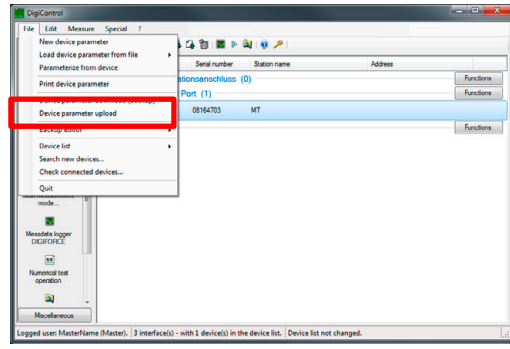

- 3 Select the data backup that you want to use to overwrite all the settings.

- 4 If you want to overwrite all the device parameters, click on **[Yes]**.

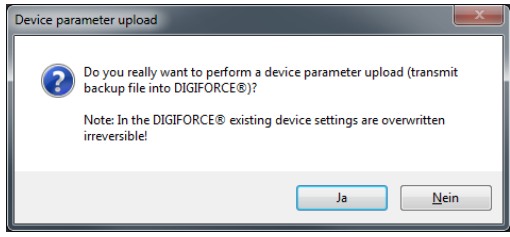

- 5 The device parameters are written to the DIGIFORCE® 9311 unit.

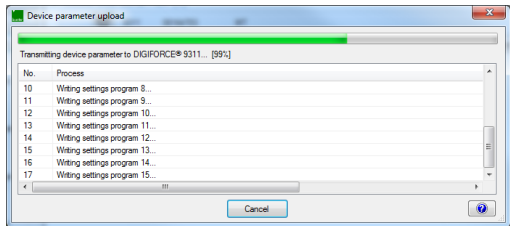

- 6 The "Device parameter upload" window closes automatically. This means that your settings and device parameters have been overwritten successfully.

10 Signal timing diagrams

10.1 Selecting a measurement program

10.1.1 Changing the measurement program without program acknowledgement

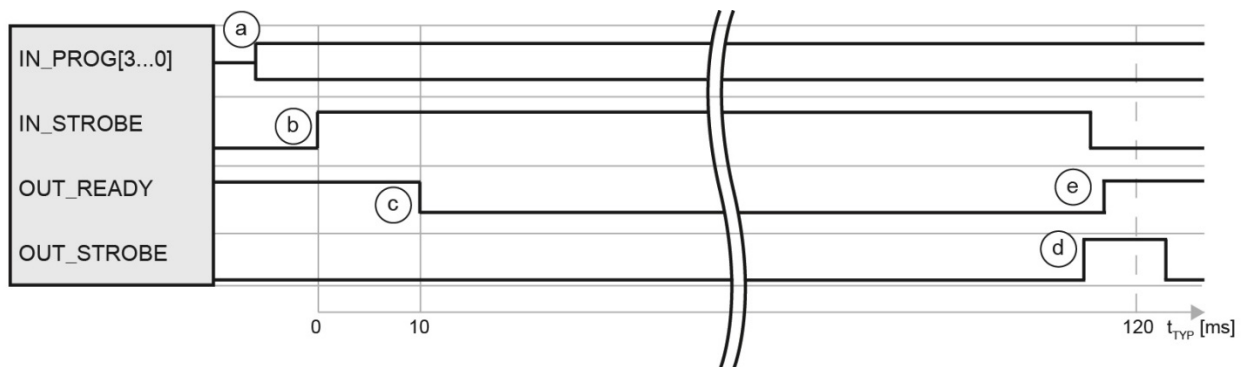

Diagram 85: Changing the measurement program without program acknowledgement

Cycle

- The controller applies the required program number (binary encoded) to the address inputs and checks whether the DIGIFORCE® 9311 is ready ("OUT_READY" = 1).
- The controller sets the strobe signal ("IN_STROBE" = 1) in order to transfer the program number.
- On detecting the strobe signal, the DIGIFORCE® 9311 sets the READY signal to "0".
- At the end of the program-selection cycle, the DIGIFORCE® 9311 enables the output signal "OUT_STROBE" as the acknowledgement for the external PLC. On detecting the "OUT_STROBE" signal from the 9311, the PLC can reset the initiating control signal "IN_STROBE" ("IN_STROBE" = 0).
- After "IN_STROBE" has been reset, the DIGIFORCE® 9311 sets the READY signal and resets "OUT_STROBE". Only then the cycle is completed.

Tip

You can connect unused address inputs ("IN_PROG[]") permanently to Ground potential.

Note: This applies only to all unused inputs. Otherwise outputs can be triggered incorrectly if extreme interference fields exist or there are large fluctuations in the PLC supply potential with respect to Ground potential.

10.1.2 Changing the measurement program with program acknowledgement

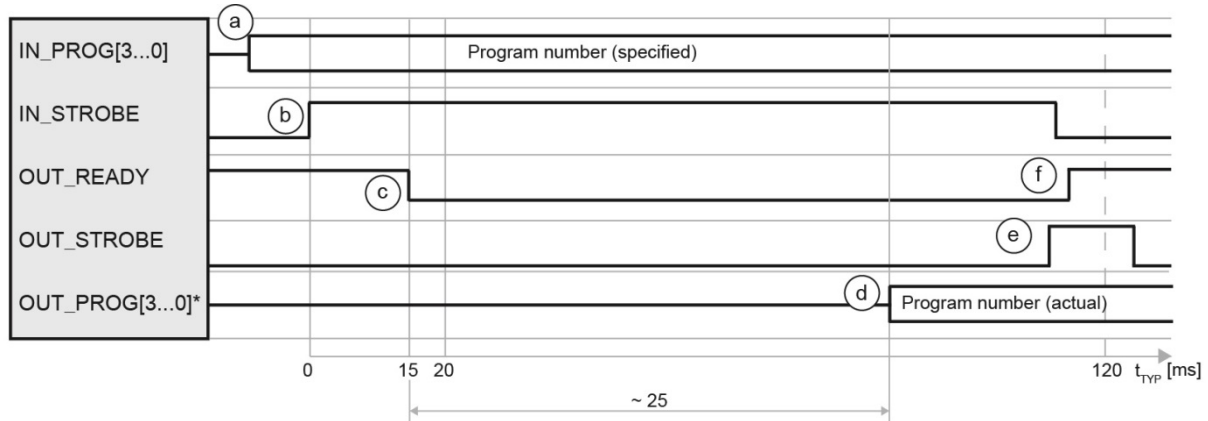

Diagram 86: Changing the measurement program with program acknowledgement

*You can define a configurable PLC output for the signals "OUT_PROG[3...0]".

Cycle

- The controller applies the required program number (binary encoded) to the address inputs and checks whether the DIGIFORCE® 9311 is ready ("OUT_READY" = 1).
- The controller sends the strobe signal ("IN_STROBE") in order to transfer the program number.
- On detecting the strobe signal, the DIGIFORCE® 9311 sets the READY signal to "0".
- The DIGIFORCE® 9311 updates the program number echoed at the address outputs ("OUT_PROG[3...0]"*) with the selected program.
- At the end of the program-selection cycle, the DIGIFORCE® 9311 enables the output signal "OUT_STROBE". On detecting the "OUT_STROBE" signal from the 9311, the PLC can receive and validate the program number "OUT_PROG[3...0]"* acknowledged by the DIGIFORCE® 9311. Then the PLC can reset the initiating control signal "IN_STROBE" ("IN_STROBE" = 0).
- After "IN_STROBE" has been reset, the DIGIFORCE® 9311 sets the READY signal and resets "OUT_STROBE". Only then the cycle is completed.

Tip

You can connect unused address inputs ("IN_PROG[...]"*) permanently to Ground potential.

Note: This applies only to all unused inputs. Otherwise outputs can be triggered incorrectly if extreme interference fields exist or there are large fluctuations in the PLC supply potential with respect to Ground potential.

10.2 Starting a measurement

Instead of using external signals, you can also use separate internal events to start and stop a measurement in the DIGIFORCE[®] 9311. You define the necessary settings for this in the Measurement mode configuration menu; for details, please see section 6.3.2.6.4 "Start/Stop mode" on page 78.

10.2.1 Measurement without measurement-data logging

Standard measurement cycle without active logging of measurement data via the communication interfaces (Ethernet, USB). For a Fieldbus interface, all result values are immediately available once "OUT_READY" = 1.

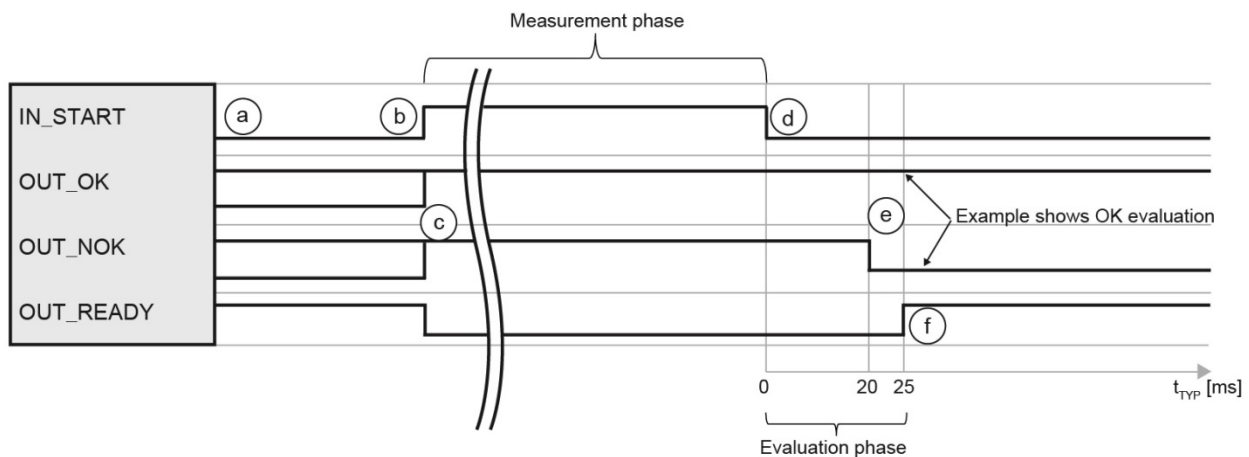

Diagram 87: Without measurement-data logging

Cycle

- The controller (PLC) checks whether the DIGIFORCE[®] 9311 is ready ("OUT_READY" = 1).
- The PLC starts the measurement with "IN_START" = 1.
- During the measurement phase the DIGIFORCE[®] 9311 sets the signals "OUT_OK" and "OUT_NOK" to 1 and the signal "OUT_READY" to 0.
- The PLC stops the measurement by resetting the signal "IN_START" to 0.
- The DIGIFORCE[®] 9311 updates the result during the evaluation phase:
 - "OUT_OK" = 1 and "OUT_NOK" = 0: measurement OK
 - "OUT_OK" = 0 and "OUT_NOK" = 1: measurement NOK
- At the end of the evaluation phase, the DIGIFORCE[®] 9311 sets the signal "OUT_READY" to 1 (in standby).

Note: As soon as the process has finished, the PLC (I/O or Fieldbus) can withdraw the Start signal to stop the measurement phase. This applies only when an external Stop has been selected. If an external Stop has not been configured, the Start can be withdrawn even before the end of the process. After detecting the Stop, the DIGIFORCE[®] 9311 evaluates the recorded measured values and sets the evaluation signals OK or NOK. The other evaluation signal in each case is set to "0". Once the full sequence has finished, the DIGIFORCE[®] 9311 sets the READY signal.

10.2.2 Measurement with measurement-data logging

The DigiControl PLUS PC software for the DIGIFORCE® 9311 provides the option for automatic data logging at the end of a measurement. When data logging is enabled, the "OUT_READY" signal, which indicates that the DIGIFORCE® 9311 is in standby and ready to perform another measurement, is not set until data transmission is complete. The time taken for data logging depends on the choice of communication interface and on the size of the measurement curve. The time length for data logging shown in the signal timing diagram is the time typically taken when the Ethernet port is used.

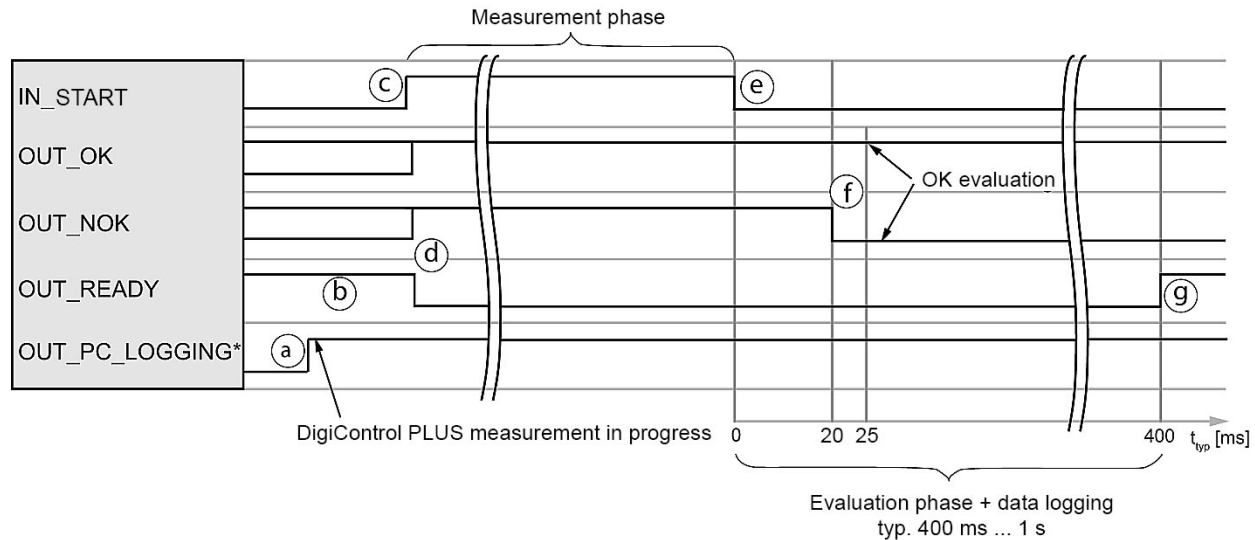

Diagram 88: With measurement-data logging

*You can define a configurable PLC output for the signal "OUT_PC_LOGGING".

Cycle

- a. DigiControl PLUS (PC software) sets the signal "OUT_PC_LOGGING" to 1 when measurement mode starts.
- b. The controller (PLC) checks whether the DIGIFORCE® 9311 is ready ("OUT_READY" = 1).
- c. The PLC starts the measurement with "IN_START" = 1.
- d. During the measurement phase the DIGIFORCE® 9311 sets the signals "OUT_OK" and "OUT_NOK" to 1 and the signal "OUT_READY" to 0.
- e. The PLC stops the measurement by resetting the signal "IN_START" to 0.
- f. The DIGIFORCE® 9311 updates the result during the evaluation phase:
 "OUT_OK" = 1 and "OUT_NOK" = 0: measurement OK
 "OUT_OK" = 0 and "OUT_NOK" = 1: measurement NOK
- g. At the end of the evaluation phase, the DIGIFORCE® 9311 sets the signal "OUT_READY" to 1 (in standby).

Tip

To optimize cycle times, the PLC can retrieve the OK/NOK evaluation immediately after the measurement rather than waiting for the READY signal, which it can check before the next measurement.

10.2.3 Measurement using data logging on USB stick (READY control enabled)

When data logging on a USB stick is active, for each measurement a data entry is made on the USB stick plugged into the front of the DIGIFORCE® 9311 (please see section 6.3.1.1 “USB flash” on page 47).

Note: If you wish to log the measurement data on the USB stick, you need to enable data logging in each measurement program concerned.

If an access error for the USB stick occurs when USB-stick data logging is active (e.g. if the USB stick has been removed), then the "ERR-LED" is activated and the "READY" signal is no longer indicated.

You can opt to disable the READY control if you do not want USB-stick data logging to be performed in sync with the READY signal (please see section 6.3.1.1 “USB flash” on page 47).

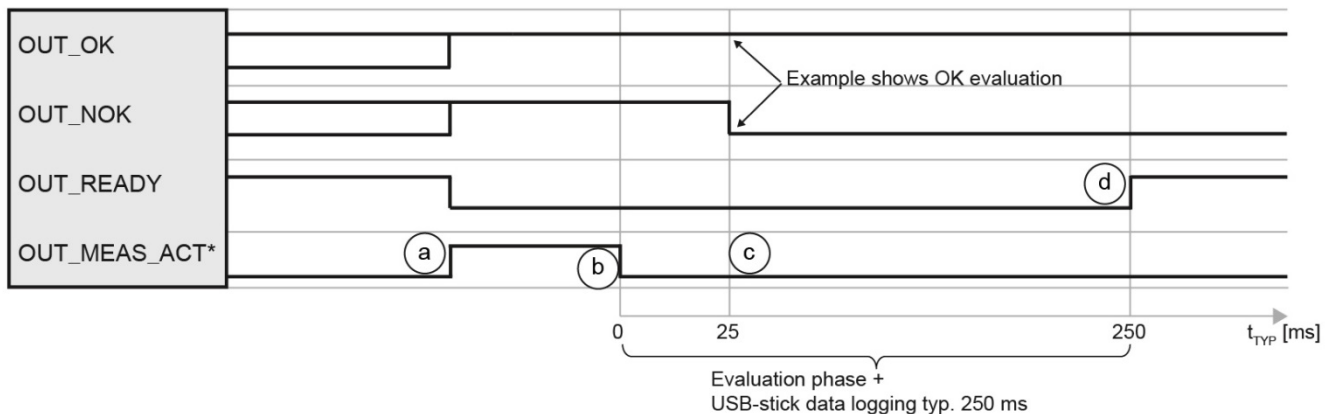

Diagram 89: Measurement with data logging on USB stick

*You can define a configurable PLC output for the signal "OUT_MEAS_ACT".

Note: When data logging on USB stick is active, the *.csv file is generated and a "HEADER" saved in the file after the first measurement. This introduces a one-off delay (READY = 1) of typically 1 to 2 seconds.

Cycle

- Depending on the option selected, the DIGIFORCE® 9311 uses an internal condition or the control signal "IN_START" to start a measurement.
- During the measurement phase the DIGIFORCE® 9311 sets the signals "OUT_OK" and "OUT_NOK" to 1 and the signal "OUT_READY" to 0. The DIGIFORCE® 9311 can signal the actual measurement phase using the output "OUT_MEAS_ACT" = 1 (measurement active).
- The evaluation phase in the DIGIFORCE® 9311 starts once the active measurement phase ends ("OUT_MEAS_ACT" = 0).
- The DIGIFORCE® 9311 updates the result during the evaluation phase:
- "OUT_OK" = 1 and "OUT_NOK" = 0: measurement OK
"OUT_OK" = 0 and "OUT_NOK" = 1: measurement NOK

At the end of the evaluation phase, the DIGIFORCE® 9311 creates or accesses the *.csv file on the USB stick (please see section 6.3.1.1 “USB flash” on page 47).

- Once the evaluation phase and USB-stick data logging have finished, the DIGIFORCE® 9311 sets the signal "OUT_READY" to 1 (in standby).

10.3 External tare

10.3.1 Without tare warning

Standard cycle without monitoring of the tare warning limit using measurement channel "Y1" as an example.

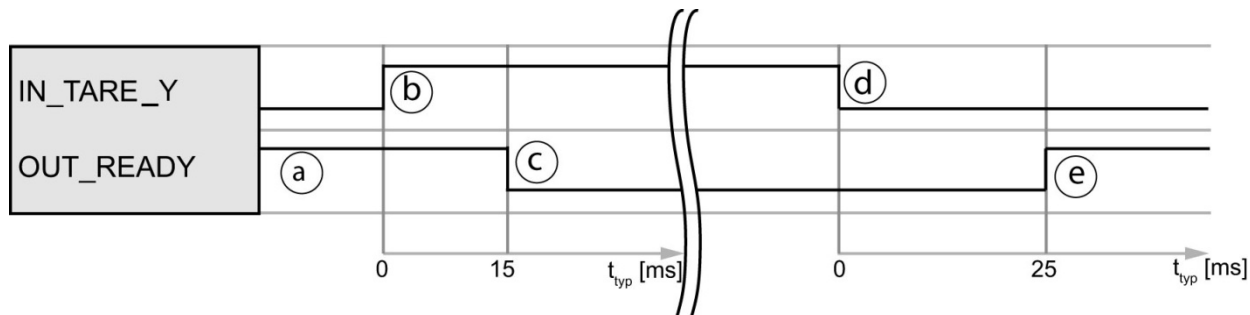

Diagram 90: Without tare warning

Cycle

- The PLC first checks whether the DIGIFORCE[®] 9311 is ready, i.e. if "OUT_READY" = 1.
- The PLC initiates the tare procedure with "IN_TARE_Y" = 1.
- The DIGIFORCE[®] 9311 then resets "OUT_READY" to 0.
- On detecting "OUT_READY" = 0, the PLC can withdraw the tare request ("IN_TARE_Y"=0).
- Once the process has finished, the DIGIFORCE[®] 9311 sets "OUT_READY" = 1 (in standby).

10.3.2 With tare warning

The DIGIFORCE[®] 9311 can generate a warning if the sensor signal to be tared exceeds a configurable threshold value. You can enable and set this threshold in the "Channel settings" (for further details, please see section 6.3.2.1 "Channel settings" on page 55).

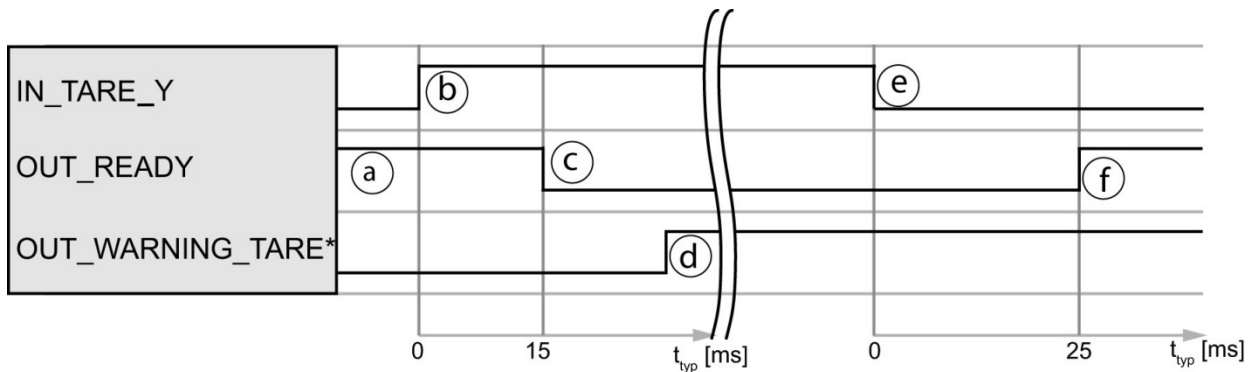

Diagram 91: With tare warning

*You can define a configurable PLC output for the signal "OUT_WARNING_TARE".

Cycle

- The PLC first checks whether the DIGIFORCE[®] 9311 is ready, i.e. if "OUT_READY" = 1.
- The PLC initiates the tare procedure with "IN_TARE_Y" = 1.
- The DIGIFORCE[®] 9311 then resets "OUT_READY" to 0.
- If the live sensor signal exceeds the set warning limit, the DIGIFORCE[®] 9311 sets the output "OUT_WARNING_TARE".
- On detecting "OUT_READY" = 0, the PLC can use "IN_TARE_Y" to stop the tare process.
- At the end of the cycle, the DIGIFORCE[®] 9311 sets "OUT_READY" to 1 (in standby). The PLC can now evaluate the "OUT_WARNING_TARE" warning output signal.

Note: The warning is withdrawn if the warning condition was no longer met in another tare process, or if "Tare" has been disabled.

10.4 Online signals

10.4.1 Window evaluation with online signal

For the "Window" evaluation element you can specify that the DIGIFORCE® 9311 enables the "OUT_NOK_ONL" online signal if a window evaluation criterion is infringed. This function is often used to monitor the initial-contact region of press-fit processes.

If the curve exits the window incorrectly, for instance because misalignment of the parts to be joined causes an unexpected rise in force, the DIGIFORCE® 9311 enables the associated online signal. This can be used to stop the press-fit process early to pre-empt any damage to the equipment, tools or workpieces. The DIGIFORCE® 9311 resets the online signal "OUT_NOK_ONL" again once a new measurement starts.

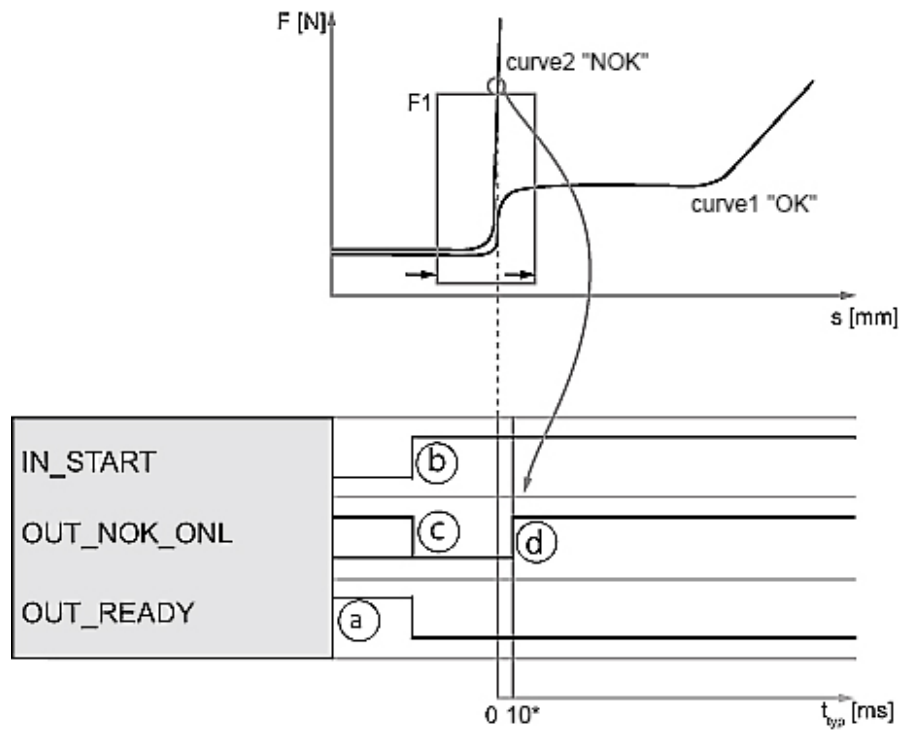

Diagram 92: Window evaluation with online signal



*The chosen signal-sampling method and filter parameters may increase the typical delay shown here.

Cycle

- a. The PLC first checks whether the DIGIFORCE® 9311 is in standby and ready to measure, i.e. if "OUT_READY" = 1.
- b. The PLC starts the measurement with "IN_START" = 1.
- c. During the measurement phase, the DIGIFORCE® 9311 sets "OUT_NOK_ONL" to 0.
- d. If the evaluation window is infringed when online evaluation is in use, the DIGIFORCE® 9311 activates the online signal.
- e. Valid crossing (e.g. from left to right without infringement): "OUT_NOK_ONL" = 0.
- f. If there is an infringement (e.g. curve exits through top of window), the DIGIFORCE® 9311 sets the online signal to "1" ("OUT_NOK_ONL" = 1).

10.4.2 Online switching signals S1 to S6

The DIGIFORCE® 9311 can enable the switching signals S1 to S6 in measurement mode and in test operation if a measurement exceeds a set value.

	 <h3 style="margin: 0;">WARNING</h3>
	<p>NOT a substitute for safety devices and protective equipment</p> <p>The online switching signals S1 to S6 are NOT a substitute for safety devices and protective equipment.</p> <p>Use safety devices and protective equipment.</p>

Note: The switching signals S1 to S6 do not meet the requirements of a safety switch. It is the responsibility of the owner of the complete system, such as a press, to equip the system with the required safety devices and protective equipment.

10.4.2.1 Switching signals for X-channel with "Absolute" reference

The DIGIFORCE® 9311 sets an X-channel switching signal when the reading on the X-channel exceeds the set value with respect to the "Absolute" reference. If the reading falls below the set value, the DIGIFORCE® 9311 resets the signal back to its default status. In the "Absolute" reference case, the DIGIFORCE® 9311 uses the zero point of the sensor configured for this channel as the reference.

The DIGIFORCE® 9311 can set/reset the signal in measurement mode both in standby (ready to measure) and during an active measurement.

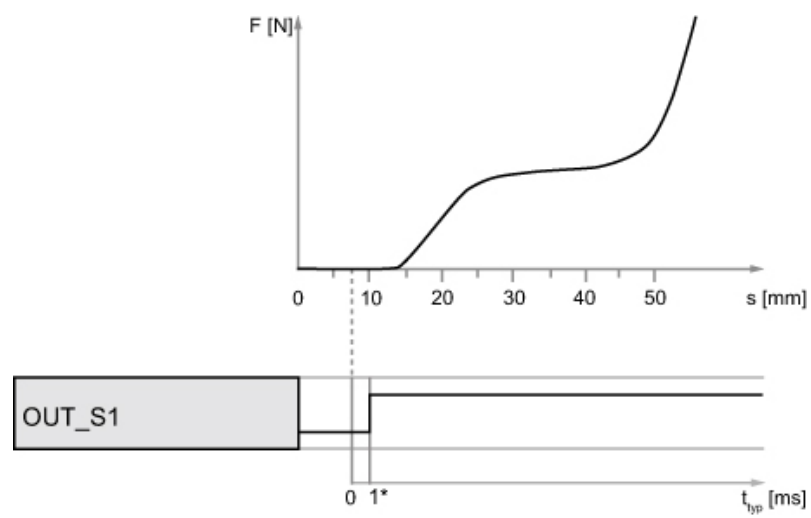

Diagram 93: Switching signals for X-channel with "Absolute" reference

"OUT_S1" configuration	
Channel	Channel
Value	Value
Reference	Reference

*Low-frequency low-pass filtering (filter value in channel settings) may extend the typical delay shown.

10.4.2.2 Switching signals for X-channel with "Trigger" reference

The DIGIFORCE[®] 9311 can only set/reset the X-channel switching signal with trigger reference during an active measurement, i.e. after the trigger event.

The reference for the X-channel is the trigger event, for instance this may be the contact force of a press ram on a component.

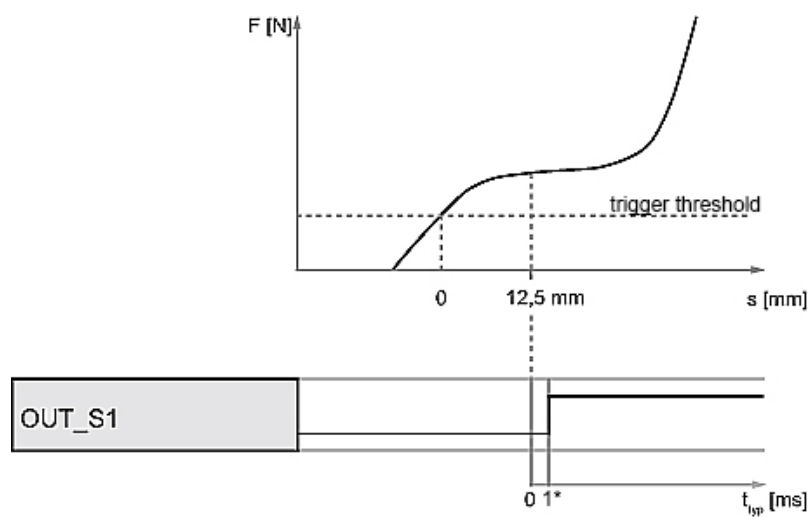

Diagram 94: Switching signals for X-channel with "Trigger" reference

"OUT_S1" configuration	
Channel	X
Value	12.5 mm
	Active high
Reference	Y trigger

*Low-frequency low-pass filtering (filter value in channel settings) may extend the typical delay shown.

10.4.2.3 Switching signals for Y-channel

The DIGIFORCE® 9311 sets a Y-channel switching signal when the reading on the Y-channel exceeds the specified Y-channel value. If the reading falls below the set value, the DIGIFORCE® 9311 resets the signal back to its default status. The signal can be set/reset in measurement mode when the DIGIFORCE® 9311 is in standby (ready to measure) and during an active measurement.

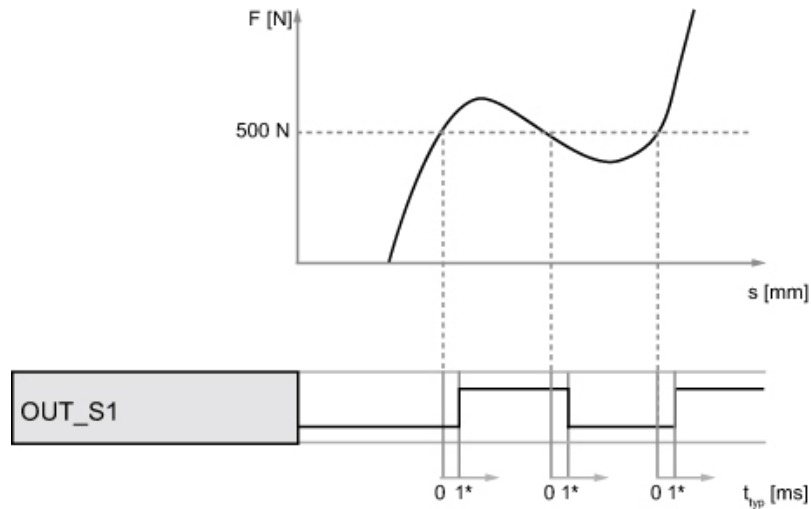

Diagram 95: Switching signals for Y-channel

"OUT_S1" configuration	
Channel	Y
Value	500 N
	Active high

*Low-frequency low-pass filtering (filter value in channel settings) may extend the typical delay shown.

10.5 Acknowledgement function

You can use the DIGIFORCE® 9311 Acknowledgement function to control indicator lights and a buzzer directly for visual and acoustic signaling of the OK/NOK evaluation. The DIGIFORCE® 9311 can also handle an acknowledge input for OK/NOK components where this is required. This acknowledgement function is linked to the "OUT_ACK_LOCK" lock output.

10.5.1 Example of an NOK evaluation for the following configuration

"Acknowledgement function" configuration	
Acknowledgement function	ON
Acknowledge OK-parts	OFF
Acknowledge NOK-parts	ON

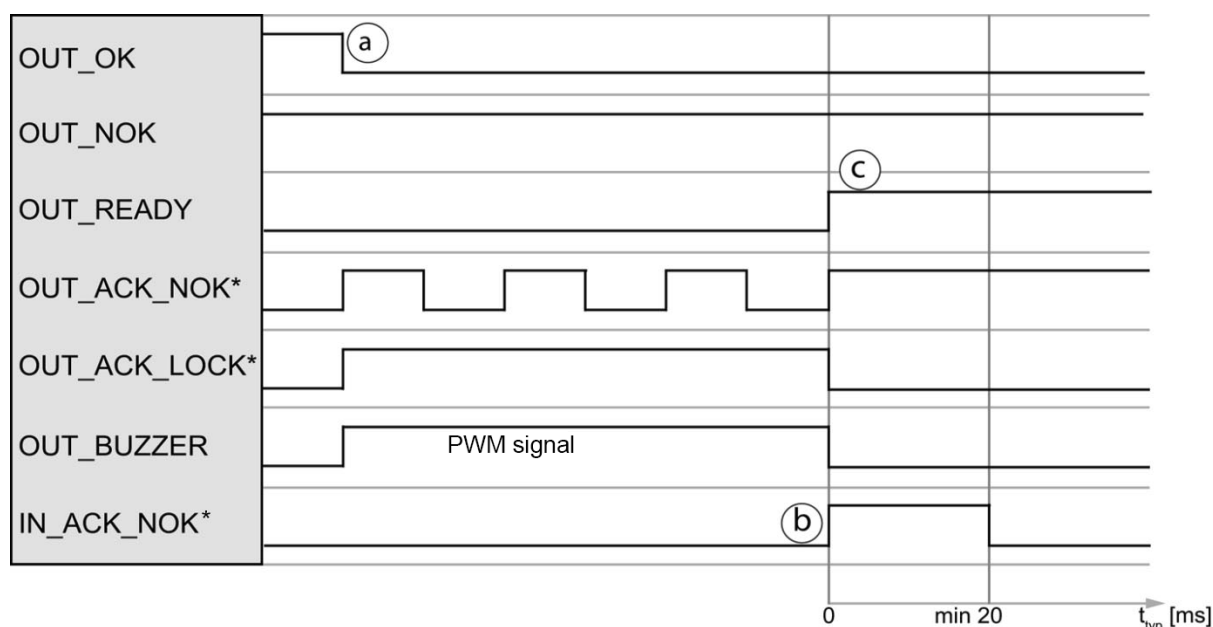

Diagram 96: Example of an NOK evaluation

*You can define a configurable PLC output for the output signals "OUT_ACK_NOK" and "OUT_ACK_LOCK". You can define a configurable PLC input for the signal "IN_ACK_NOK".

Cycle

- During the evaluation phase following a measurement, the DIGIFORCE® 9311 updates the control signals for the evaluation "OUT_OK" and "OUT_NOK" (in this case "OUT_NOK" = 1). In addition, the DIGIFORCE® 9311 activates the "OUT_ACK_NOK" indicator-light signal (flashing), sets the lock output signal "OUT_ACK_LOCK" to 1 and activates the buzzer output "OUT_BUZZER" (PWM signal).
- On detecting the acknowledgement from the user ("IN_ACK_NOK" = 1), the DIGIFORCE® 9311 sets the indicator-light signal "OUT_ACK_NOK" to 1 (solid light). The DIGIFORCE® 9311 simultaneously sets the lock output signal "OUT_ACK_LOCK" to 0 and the buzzer output "OUT_BUZZER" to 0.
- At the end of the cycle, the DIGIFORCE® 9311 sets "OUT_READY" to 1 (in standby). The indicator-light signal "OUT_ACK_NOK" remains active until the start of the next measurement.

10.5.2 Example of an NOK evaluation (without acknowledgement)

Configuration	
Acknowledgement function	Acknowledgement function
Acknowledge OK-parts	Acknowledge OK-parts
Acknowledge NOK-parts	Acknowledge NOK-parts

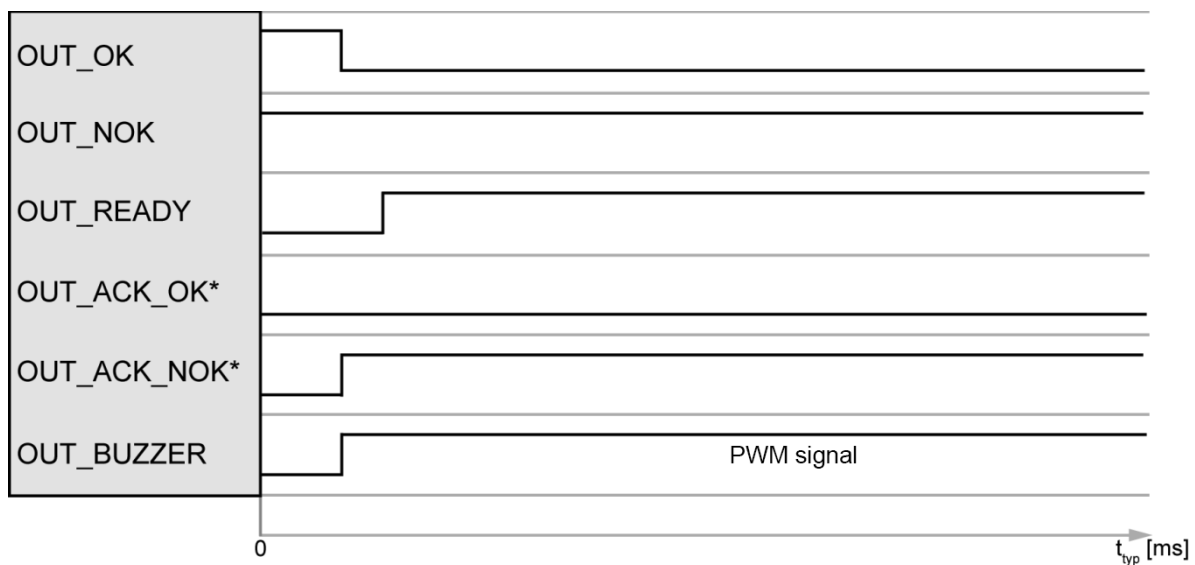

Diagram 97: Example of an NOK evaluation (without acknowledgement)

*You can define a configurable PLC output for the signals "OUT_ACK_OK" and "OUT_ACK_NOK".

Note: The buzzer is active here until the start of the next measurement.

10.5.3 Example of an OK evaluation (without acknowledgement)

Configuration	
Acknowledgement function	Acknowledgement function
Acknowledge OK-parts	Acknowledge OK-parts
Acknowledge NOK-parts	Acknowledge NOK-parts

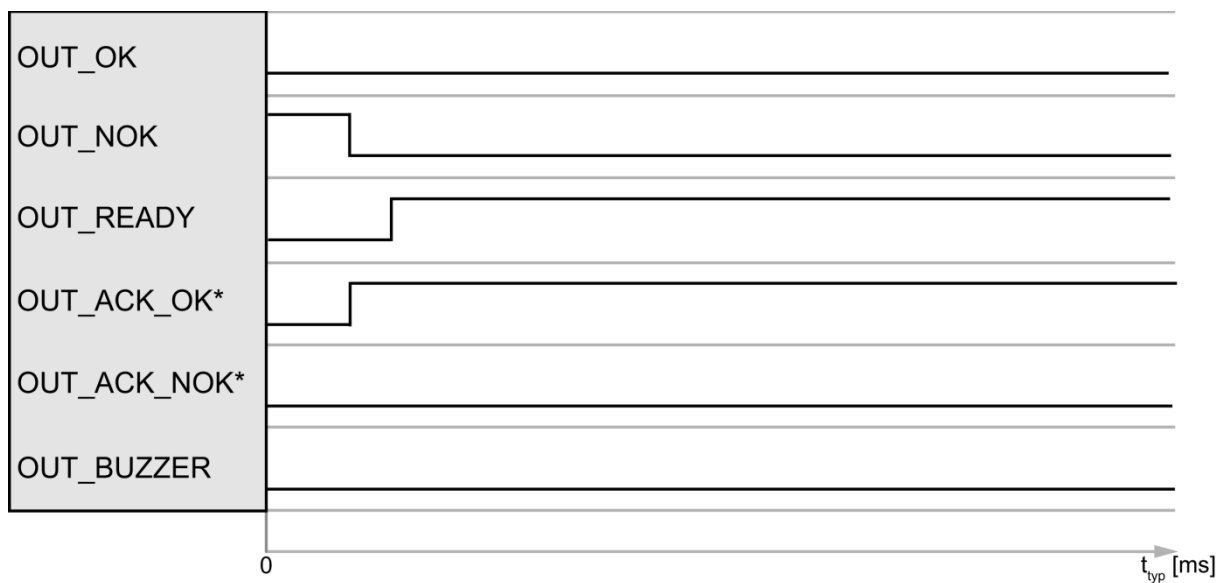

Diagram 98: Example of an OK evaluation (without acknowledgement)

*You can define a configurable PLC output for the signals "OUT_ACK_OK" and "OUT_ACK_NOK".

10.6 External actuation of a statistics reset

You can use the "IN_RESET" control signal to reset the part counter and NOK counter and also the evaluation element statistics. The DIGIFORCE® 9311 resets the statistics for all the measurement programs in this case.

The following values are reset by this function:

- Part counter and NOK counter for all measurement programs
- NOK percentage for all measurement programs

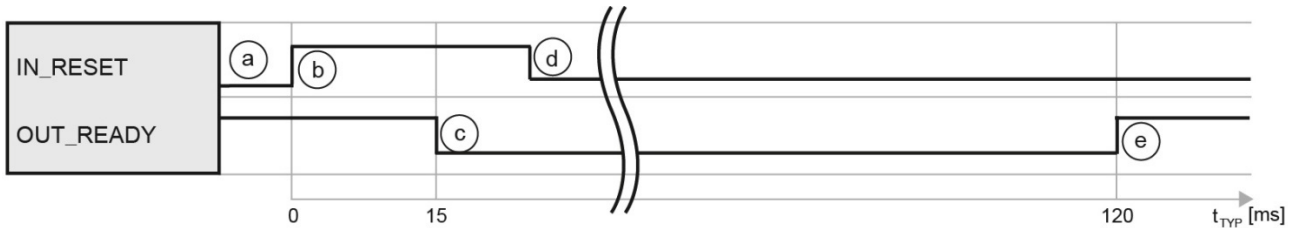

Diagram 99: External actuation of a statistics reset

Cycle

- The PLC first checks whether the DIGIFORCE® 9311 is ready, i.e. if "OUT_READY" = 1.
- The PLC initiates the reset process with "IN_RESET" = 1.
- The DIGIFORCE® 9311 then resets "OUT_READY" to 0.
- On detecting "OUT_READY" = 0, the PLC withdraws the reset request with "IN_RESET" = 0.
- At the end of the cycle, the DIGIFORCE® 9311 sets "OUT_READY" to 1 (in standby).

10.7 External actuation of a sensor test

You can use the "IN_STEST" signal to run the "sensor test" configured in the DIGIFORCE[®] 9311. In this test, you can check the sensor signals from measurement channels X and Y against a stored value including any tolerance that has been set.

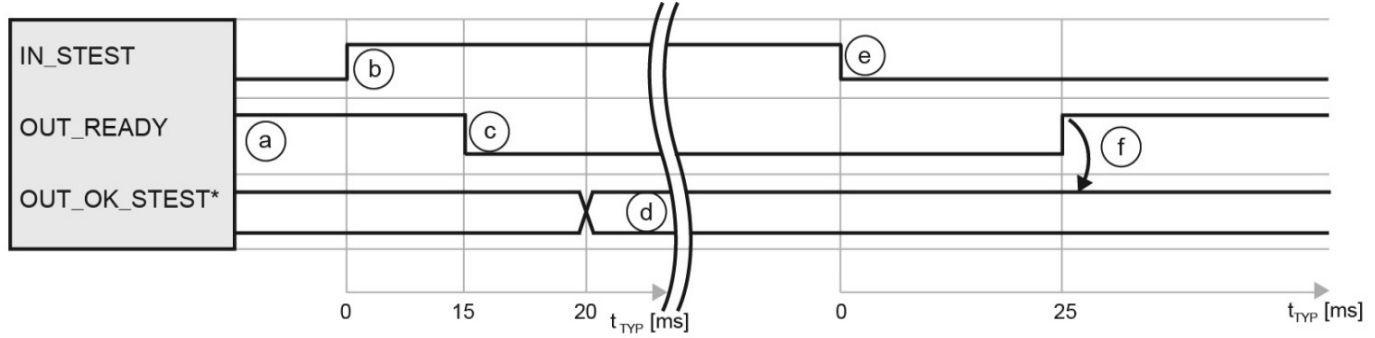

Diagram 100: External actuation of a sensor test

*You can define a configurable PLC output for the signal "OUT_OK_STEST".

Cycle

- a. The PLC first checks whether the DIGIFORCE[®] 9311 is ready, i.e. if "OUT_READY" = 1.
- b. The PLC initiates the sensor test with "IN_STEST" = 1.
- c. The DIGIFORCE[®] 9311 then resets "OUT_READY" to 0.
- d. The DIGIFORCE[®] 9311 updates the result of the sensor test:

"OUT_OK_STEST" = 0	sensor test = NOK
"OUT_OK_STEST" = 1	sensor test = OK
- e. On detecting "OUT_READY" = 0, the PLC can set "IN_STEST" to 0 to stop the process.
- f. Once the process has finished, the DIGIFORCE[®] 9311 sets "OUT_READY" = 1 (in standby). The PLC can now evaluate the "OUT_OK_STEST" result.

11 Customer Services for your DIGIFORCE® 9311

To complement the DIGIFORCE® 9311 package you have purchased, burster praezisionsmesstechnik gmbh & co kg offers the following customer services centered on the DIGIFORCE® family:

- On-site support for preparing the DIGIFORCE® 9311 for use
- Product training (in-house or on-site)
- Initial calibration and recalibration, including sensors

To inquire about our customer services for your DIGIFORCE® 9311, please telephone our Service department on +49-7224-645-53, or email: service@burster.com (Germany only). If you are outside Germany, you should contact your burster agent (see also www.burster.com).

11.1 Firmware update

The device software (firmware) for the DIGIFORCE® 9311 can be updated via the USB port using the DigiControl PC software. For the DIGIFORCE® 9311 Fieldbus option (e.g. PROFINET) there is separate firmware that can also be updated via the USB port. You can find the status of the firmware in the DIGIFORCE® 9311 from the "General" tab of the "Station properties" menu in the DigiControl PC software. You can obtain information about the current firmware status for the DIGIFORCE® 9311 from our Service department on +49-7224-645-53 or via service@burster.com.

The current DigiControl PC software (base version) for performing the firmware update can be downloaded from our website at www.burster.com.

Click on the link <http://goo.gl/muUe7D> or simply use the QR code below:



You can also request the firmware files themselves from our Service department on +49-7224-645-53 or via service@burster.com.

Example

File	Stand	Meaning
SW_V201703.bin9311	22.06.2017	DIGIFORCE® 9311 Firmware Version 2017/03 standard firmware
PN-V16.1.0.nex9311	02.05.2016	DIGIFORCE® 9311 Fieldbus firmware version 2016.1.0 PROFINET firmware (for device version 9311-Vxxx3)

Note: Please be aware that when updating the device firmware, it may be necessary to update the Fieldbus firmware as well. You can obtain information about what device firmware is harmonized with what Fieldbus firmware from our Service department on +49-7224-645-53 or via service@burster.com.

DIGIFORCE® model 9311

Performing a firmware update



This is how it works

- 1 Connect the DIGIFORCE® 9311 to the PC via the USB port using a standard USB A-plug to Micro-B data cable (burster part number 9900-K358, length 1.8 m).
- 2 Run the DigiControl PC software and click "Perform device search".

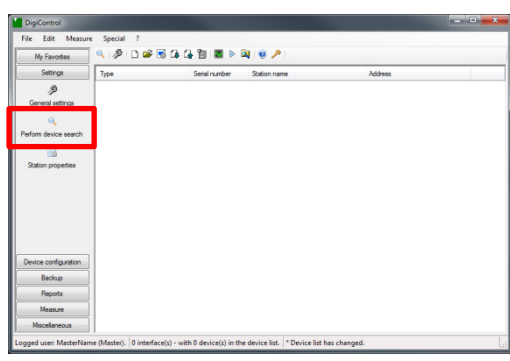

- 3 Disable "Ethernet search" and "Serial search RS 232". A device search is always performed via USB (the virtual COM port to the DIGIFORCE® 9311 is always displayed). Click **[Search...]**.
Once found, your DIGIFORCE® 9311 appears in the device list.
If the search does not find your DIGIFORCE® 9311, check in the Windows Device Manager under Ports that a COM port of type "USB Serial Port" is present and that the latest driver from the manufacturer/supplier FTDI is being used. Then repeat the device search.

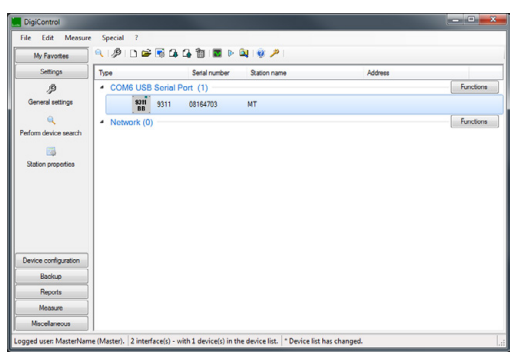
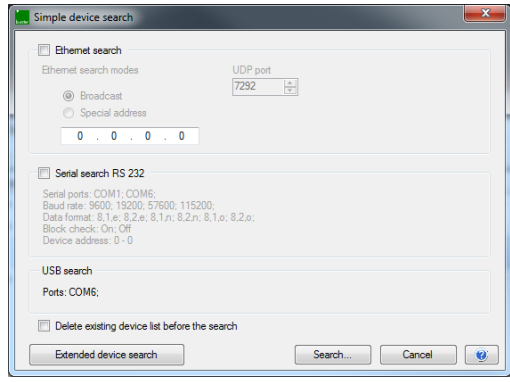

- 4 Perform a data backup as described in section 9 "Data backup" on page 139. Once the firmware has been updated, you can upload the settings again to the DIGIFORCE® 9311.

IMPORTANT: Please note that all the device settings are lost when you perform a firmware update.

- 5 Click on "?". Select "Service" and then "Update device firmware".

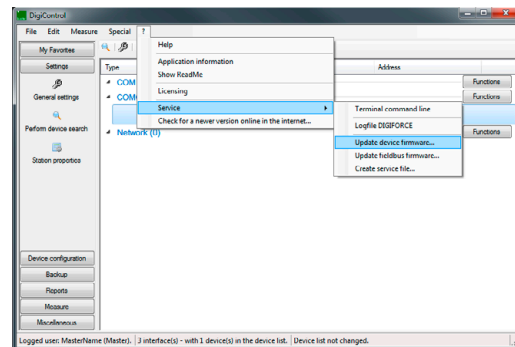

- 6 If you have performed a data backup, confirm the prompt by clicking on **[Next]**, or if necessary, cancel the function to create a data backup.

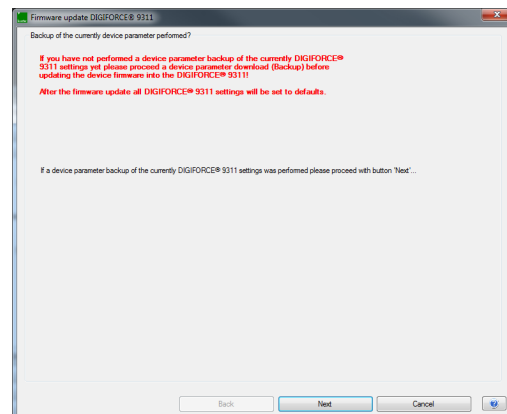

- 7 Click on **[Search file ...]**. Select the correct firmware file (e.g. SW_V201703.bin9311) from your directory and click on **[Next]**.

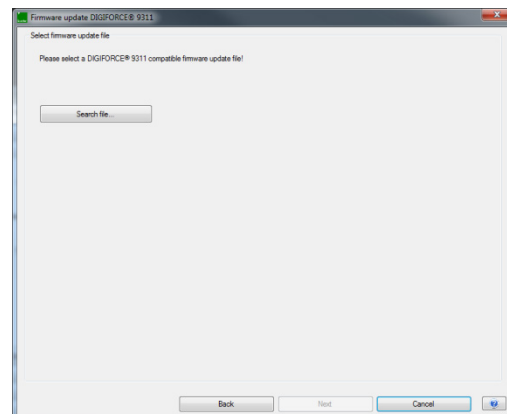

DIGIFORCE® model 9311

- 8 Disconnect the DIGIFORCE® 9311 from the power supply. Then power-up the unit again, and during power-up press the Reset button briefly using a pointed object (e.g. a pencil or small screwdriver).
 The red status LEDs "NOK" and "ERR" show a steady light at a reduced intensity. This signals that the unit is ready for the software update.
 Click on **[Next]** and follow the instructions in the DigiControl PC software.
Note: Select the port being used (normally the USB port previously used with the same virtual COM port).

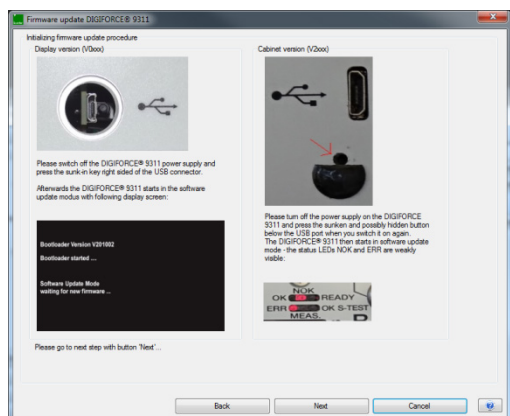
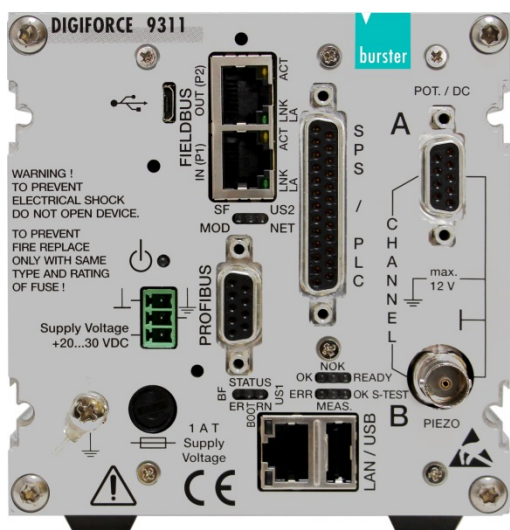

- 9 You have successfully completed the update. Once the update process has finished, all the status LEDs are illuminated for about 5 s. This shows that it was possible to start the standard application successfully in the DIGIFORCE® 9311.
 Click on **[Next]**. Then restore the backup you created earlier (see section 9.2 "Writing a data backup to the DIGIFORCE® 9311 - Upload" on page 141).
Note: In the "Station properties" menu, you can check whether the latest device firmware is now present (see section 6.2 "DIGIFORCE® 9311 device information (Properties)" on page 41).

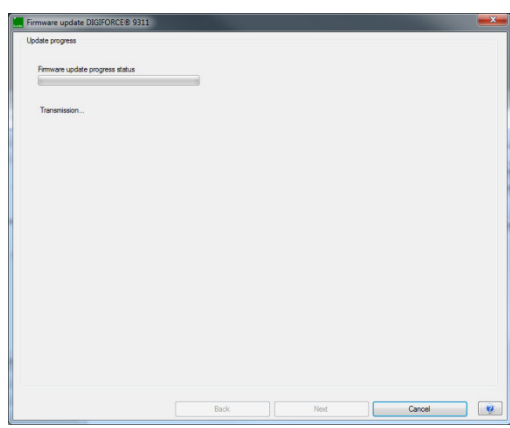

11.2 Fieldbus firmware update

You can update the firmware for the Fieldbus option in a similar way to the firmware update.

Performing a Fieldbus firmware update



This is how it works

- 1 Connect the DIGIFORCE® 9311 to the PC via the USB port using a standard USB A-plug to Micro-B data cable (burster part number 9900-K358, length 1.8 m).
- 2 Run the DigiControl PC software and click "Perform device search".

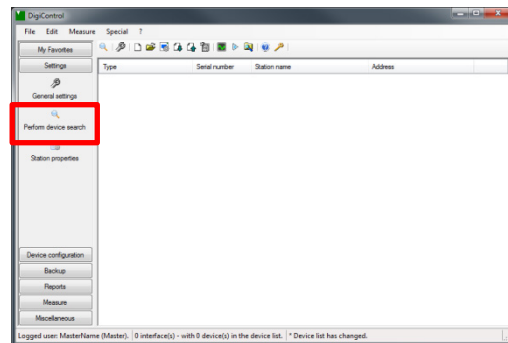

- 3 Disable "Ethernet search" and "Serial search RS 232". A device search is always performed via USB (the virtual COM port to the DIGIFORCE® 9311 is always displayed). Click **[Search...]**.
Once found, your DIGIFORCE® 9311 appears in the device list.
If the search does not find your DIGIFORCE® 9311, check in the Windows Device Manager under Ports that a COM port of type "USB Serial Port" is present and that the latest driver from the manufacturer/supplier FTDI is being used. Then repeat the device search.

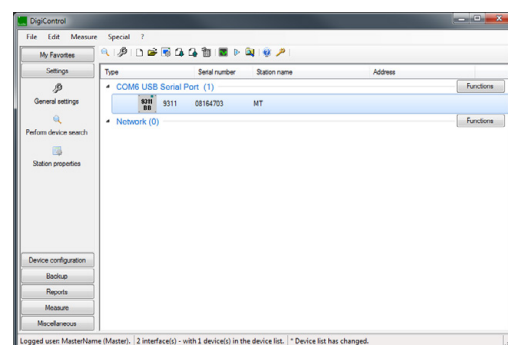
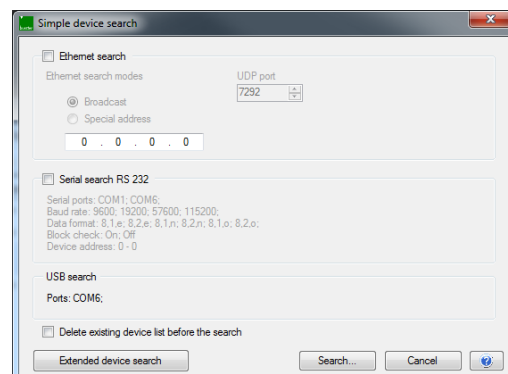

DIGIFORCE® model 9311

- 4 Click on "?". Select "Service" and then "Update Fieldbus firmware".

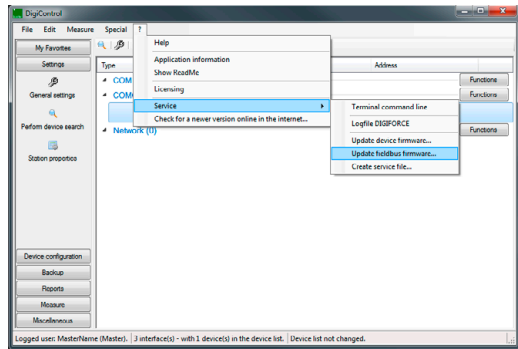

- 5 Select the correct file (e.g. PN-V16.1.0.nex9311 for PROFINET) from your directory and click on **[Open]**.

- 6 Click on **[Yes]** and wait until the message is displayed saying "The update of the field bus firmware was successfully transmitted to the device." Click on **[OK]** and restart the DIGIFORCE® 9311. It is operational again.

Note: The device settings in the DIGIFORCE® 9311 are not affected by the update to the Fieldbus firmware.

Note: In the "Station properties" menu you can check whether the latest device firmware is now present (see section 6.2 "DIGIFORCE® 9311 device information (Properties)" on page 41).

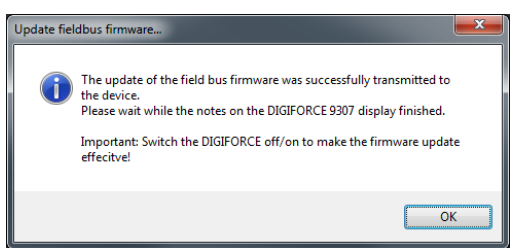

12 Technical data

Please refer to the data sheet for the technical specification. You can obtain the latest data sheet and additional information on the DIGIFORCE® 9311 from <http://goo.gl/muUe7D> or simply use the QR code below:



12.1 Electromagnetic compatibility

12.1.1 Interference immunity

Interference immunity in compliance with EN 61326-1:2013
Industrial environment

12.1.2 Interference emission

Interference emission in compliance with EN 61326-1:2013

13 Accessories available

Please refer to the data sheet for details of the accessories available. You can obtain the latest data sheet and additional information on the DIGIFORCE[®] 9311 from <http://goo.gl/muUe7D> or simply use the QR code below:



13.1 Software

The data sheet contains details of the various versions of the DigiControl PC software. You can obtain the latest data sheet and additional information on the DIGIFORCE[®] 9311 from <http://goo.gl/muUe7D> or simply use the QR code below:



14 Disposal



Battery disposal

In Germany, the end user is legally obliged to return all used batteries, and it is illegal to dispose of batteries in the household waste. This law may also affect you as purchaser of the instrument described here. Please dispose of your used batteries properly and in accordance with national statutory regulations. Either take them to the relevant collection point in your organization or to the collection points provided by your local authority, our company or any battery retail outlet.

Instrument disposal

If your instrument is no longer usable, please comply with your legal obligations by disposing of the instrument described here in accordance with statutory regulations. You will then be helping to protect the environment!